

Dimension ES-2024

Ethernet Switch

February 2004

Version 3.50

User's Guide



Copyright

Copyright © 2004 by ZyXEL Communications Corporation

The contents of this publication may not be reproduced in any part or as a whole, transcribed, stored in a retrieval system, translated into any language, or transmitted in any form or by any means, electronic, mechanical, magnetic, optical, chemical, photocopying, manual, or otherwise, without the prior written permission of ZyXEL Communications Corporation.

Published by ZyXEL Communications Corporation. All rights reserved.

Disclaimer

ZyXEL does not assume any liability arising out of the application or use of any products, or software described herein. Neither does it convey any license under its patent rights nor the patents rights of others. ZyXEL further reserves the right to make changes in any products described herein without notice. This publication is subject to change without notice.

Trademarks

Trademarks mentioned in this publication are used for identification purposes only and may be properties of their respective owners.

ZyXEL Limited Warranty

ZyXEL warrants to the original end user (purchaser) that this product is free from any defects in materials or workmanship for a period of up to two (2) years from the date of purchase. During the warranty period and upon proof of purchase, should the product have indications of failure due to faulty workmanship and/or materials, ZyXEL will, at its discretion, repair or replace the defective products or components without charge for either parts or labor and to whatever extent it shall deem necessary to restore the product or components to proper operating condition. Any replacement will consist of a new or re-manufactured functionally equivalent product of equal value, and will be solely at the discretion of ZyXEL. This warranty shall not apply if the product is modified, misused, tampered with, damaged by an act of God, or subjected to abnormal working conditions.

Note

Repair or replacement, as provided under this warranty, is the exclusive remedy of the purchaser. This warranty is in lieu of all other warranties, express or implied, including any implied warranty of merchantability or fitness for a particular use or purpose. ZyXEL shall in no event be held liable for indirect or consequential damages of any kind of character to the purchaser.

To obtain the services of this warranty, contact ZyXEL's Service Center for your Return Material Authorization number (RMA). Products must be returned Postage Prepaid. It is recommended that the unit be insured when shipped. Any returned products without proof of purchase or those with an out-dated warranty will be repaired or replaced (at the discretion of ZyXEL) and the customer will be billed for parts and labor. All repaired or replaced products will be shipped by ZyXEL to the corresponding return address, Postage Paid. This warranty gives you specific legal rights, and you may also have other rights that vary from country to country.

Interference Statements and Warnings

FCC Interference Statement

This switch complies with Part 15 of the FCC rules. Operation is subject to the following two conditions:

- (1) This switch may not cause harmful interference.
- (2) This switch must accept any interference received, including interference that may cause undesired operations.

FCC Warning

This equipment has been tested and found to comply with the limits for a Class A digital switch, pursuant to Part 15 of the FCC Rules. These limits are designed to provide reasonable protection against harmful interference in a commercial environment. This equipment generates, uses, and can radiate radio frequency energy and, if not installed and used in accordance with the instruction manual, may cause harmful interference to radio communications. Operation of this equipment in a residential area is likely to cause harmful interference in which case the user will be required to correct the interference at his own expense.

CE Mark Warning:

This is a class A product. In a domestic environment this product may cause radio interference in which case the user may be required to take adequate measures.

Taiwanese BSMI (Bureau of Standards, Metrology and Inspection) A Warning:

警告使用者

這是甲類的資訊產品, 在居住的環境使用時,
可能造成射頻干擾, 在這種情況下,
使用者會被要求採取某些適當的對策.

Certifications

Go to www.zyxel.com

Select your product from the drop-down list box on the ZyXEL home page to go to that product's page.

Select the certification you wish to view from this page.

Registration

Register your product online for free future product updates and information at www.zyxel.com for global products, or at www.us.zyxel.com for North American products.

Customer Support

If you have questions about your ZyXEL product or desire assistance, contact ZyXEL Communications Corporation offices worldwide, in one of the following ways:

Contacting Customer Support

When you contact your customer support representative, have the following information ready:

- ◆ Product model and serial number.
- ◆ Firmware version information.
- ◆ Warranty information.
- ◆ Date you received your product.
- ◆ Brief description of the problem and the steps you took to solve it.

METHOD LOCATION	SUPPORT E-MAIL SALES E-MAIL	TELEPHONE ¹ FAX ¹	WEB SITE FTP SITE	REGULAR MAIL
WORLDWIDE	support@zyxel.com.tw sales@zyxel.com.tw	+886-3-578-3942 +886-3-578-2439	www.zyxel.com www.europe.zyxel.com ftp.zyxel.com ftp.europe.zyxel.com	ZyXEL Communications Corp. 6 Innovation Road II Science Park Hsinchu 300 Taiwan
NORTH AMERICA	support@zyxel.com sales@zyxel.com	+1-800-255-4101 +1-714-632-0882 +1-714-632-0858	www.us.zyxel.com ftp.us.zyxel.com	ZyXEL Communications Inc. 1130 N. Miller St. Anaheim CA 92806-2001 U.S.A.
GERMANY	support@zyxel.de sales@zyxel.de	+49-2405-6909-0 +49-2405-6909-99	www.zyxel.de	ZyXEL Deutschland GmbH. Adenauerstr. 20/A2 D-52146 Wuerselen Germany
FRANCE	info@zyxel.fr	+33 (0)4 72 52 97 97 +33 (0)4 72 52 19 20	www.zyxel.fr	ZyXEL France 1 rue des Vergers Bat. 1 / C 69760 Limonest France
SPAIN	support@zyxel.es sales@zyxel.es	+34 902 195 420 +34 913 005 345	www.zyxel.es	ZyXEL Communications Alejandro Villegas 33 1º, 28043 Madrid Spain
DENMARK	support@zyxel.dk sales@zyxel.dk	+45 39 55 07 00 +45 39 55 07 07	www.zyxel.dk	ZyXEL Communications A/S Columbusvej 5 2860 Soeborg Denmark
NORWAY	support@zyxel.no sales@zyxel.no	+47 22 80 61 80 +47 22 80 61 81	www.zyxel.no	ZyXEL Communications A/S Nils Hansens vei 13 0667 Oslo Norway
SWEDEN	support@zyxel.se sales@zyxel.se	+46 31 744 7700 +46 31 744 7701	www.zyxel.se	ZyXEL Communications A/S Sjöporten 4, 41764 Göteborg Sweden
FINLAND	support@zyxel.fi sales@zyxel.fi	+358-9-4780-8411 +358-9-4780 8448	www.zyxel.fi	ZyXEL Communications Oy Malminkaari 10 00700 Helsinki Finland

¹ “+” is the (prefix) number you enter to make an international telephone call.

Table of Contents

Part I	I
Chapter 1 Getting to Know the ES-2024.....	1-1
1.1 Features	1-1
1.2 Applications	1-3
Part II	II
Chapter 2 Hardware Installation.....	2-1
2.1 Installation Scenarios	2-1
Chapter 3 Hardware Connections.....	3-1
3.1 Safety Warnings	3-1
3.2 Front Panel	3-1
3.3 Rear Panel	3-4
3.4 Front Panel LEDs.....	3-5
3.5 Configuring the ES-2024	3-6
Part III	III
Chapter 4 Introducing the Web Configurator	4-1
4.1 Introduction.....	4-1
4.2 System Login	4-1
4.3 Status Screen	4-1
4.4 Switch Lockout	4-5
4.5 Resetting the Switch.....	4-5
Chapter 5 System Status and Port Details.....	5-1
5.1 About System Statistics and Information.....	5-1
5.2 Port Status Summary	5-1
Chapter 6 Basic Setting.....	6-1
6.1 Introducing The Basic Setting Screens	6-1
6.2 System Information	6-1
6.3 General Setup	6-3
6.4 Introduction to VLANs	6-4
6.5 IGMP Snooping	6-5
6.6 Switch Setup Screen.....	6-5

6.7	IP Setup	6-8
6.8	Port Setup	6-9
Part IV	IV
Chapter 7	VLAN.....	7-1
7.1	Introduction to IEEE 802.1Q Tagged VLAN.....	7-1
7.2	802.1Q VLAN	7-3
7.3	Introduction to Port-based VLANs	7-10
Chapter 8	Static MAC Forward Setup	8-1
8.1	Introduction to Static MAC Forward Setup	8-1
8.2	Configuring Static MAC Forwarding.....	8-1
8.3	Viewing and Editing Static MAC Forwarding Rules.....	8-2
Chapter 9	Spanning Tree Protocol	9-1
9.1	Introduction to Spanning Tree Protocol (STP).....	9-1
9.2	STP Status	9-2
Chapter 10	Bandwidth Control	10-1
10.1	Introduction to Bandwidth Control	10-1
Part V	V
Chapter 12	Broadcast Storm Control	12-1
12.1	Introducing Broadcast Storm Control	12-1
12.2	Configuring Broadcast Storm Control.....	12-1
Chapter 13	Mirroring.....	13-1
13.1	Introduction to Port Mirroring.....	13-1
13.2	Port Mirroring Configuration	13-1
Chapter 14	Link Aggregation	14-1
14.1	Introduction to Link Aggregation.....	14-1
14.2	Link Aggregation Protocol Status	14-2
14.3	Link Aggregation Setup	14-4
Chapter 15	Port Authentication.....	15-1
15.1	Introduction to Authentication	15-1
15.2	Configuring Port Authentication	15-1
Chapter 16	Port Security	16-1
16.1	About Port Security	16-1

16.2	Port Security Setup.....	16-1
Chapter 17	Access Control	17-1
17.1	About Access Control	17-1
17.2	Access Control Overview.....	17-1
17.3	About SNMP	17-2
17.4	Service Access Control	17-6
17.5	Remote Management.....	17-6
Chapter 18	Queuing Method	18-1
18.1	Introduction to Queuing	18-1
18.2	Configuring Queuing.....	18-1
18.3	Weighted Round Robin Scheduling Example.....	18-2
Part VI	VI
Chapter 19	Routing Protocol.....	19-1
19.1	Static Route	19-1
Chapter 20	Maintenance	20-1
20.1	Maintenance	20-1
20.2	Firmware Upgrade	20-1
20.3	Restore a Configuration File	20-2
20.4	Backing Up a Configuration File	20-2
20.5	Load Factory Defaults	20-3
20.6	Reboot System	20-3
20.7	Command Line FTP.....	20-4
Chapter 21	Diagnostic.....	21-1
21.1	Diagnostic	21-1
Chapter 22	Cluster Management	22-1
22.1	Introduction to Cluster Management.....	22-1
22.2	Cluster Management Status.....	22-2
22.3	Configuring Cluster Management.....	22-4
Chapter 23	MAC Table	23-1
23.1	Introduction to MAC Table.....	23-1
23.2	Viewing MAC Table.....	23-2
Chapter 24	ARP Table.....	24-1

24.1	Introduction to ARP Table	24-1
24.2	Viewing ARP Table	24-1
Part VII	VII
Chapter 25	Introduction to CLI	25-1
25.1	Command Line Interface Overview	25-1
25.2	Command Summary	25-2
Chapter 26	Command Examples	26-1
26.1	Commonly Used Commands Overview	26-1
26.2	sys Commands.....	26-1
26.3	sys cluster Commands	26-4
26.4	ip Commands.....	26-5
26.5	Enabling rstp on the Gigabit Ports.....	26-7
Chapter 27	IEEE 802.1Q Tagged VLAN Commands	27-1
27.1	IEEE 802.1Q Tagged VLAN Overview.....	27-1
27.2	Filtering Databases	27-1
27.3	Configuring Tagged VLAN	27-1
27.4	IEEE VLAN1Q Tagged VLAN Configuration Commands.....	27-3
27.5	vlan1q svlan active	27-8
27.6	vlan1q svlan inactive	27-8
27.7	vlan1q svlan list.....	27-8
27.8	vlan1q vlan list	27-9
Part VIII	VIII
A	Product Specifications	A-1
B	Index.....	B-1

List of Figures

Figure 1-1 Backbone Application	1-4
Figure 1-2 Bridging Application	1-4
Figure 1-3 High Performance Switched Workgroup Application	1-5
Figure 1-4 VLAN Workgroup Application	1-6
Figure 1-5 Shared Server Using VLAN Example.....	1-6
Figure 2-1 Attaching Rubber Feet.....	2-1
Figure 2-2 Attaching Mounting Brackets and Screws.....	2-2
Figure 2-3 Mounting the ES to an EIA standard 19-inch rack.....	2-2
Figure 3-1 ES-2024 Front Panel	3-1
Figure 3-2 Transceiver Installation Example	3-3
Figure 3-3 Installed Transceiver.....	3-3
Figure 3-4 Opening the Transceiver’s Latch Example.....	3-4
Figure 3-5 Transceiver Removal Example.....	3-4
Figure 3-6 ES-2024 Rear Panel.....	3-5
Figure 3-7 Front Panel LEDs	3-5
Figure 4-1 Web Configurator: login.....	4-1
Figure 4-2 Web Configurator Status Screen.....	4-2
Figure 4-3 Web Configurator: Change Password at Login	4-5
Figure 4-4 Resetting the Switch Via Command.....	4-6
Figure 4-5 Uploading the Default Configuration File Via Console Port.....	4-7
Figure 4-6 Web Configurator: Logout Screen.....	4-7
Figure 5-1 Port Status Summary	5-1
Figure 5-2 Status: Port Details	5-3
Figure 6-1 System Info.....	6-2
Figure 6-2 General Setup	6-3
Figure 6-3 Switch Setup.....	6-6
Figure 6-4 Port Setup	6-10
Figure 7-1 Selecting a VLAN Type.....	7-3
Figure 7-2 802.1Q VLAN Status	7-3
Figure 7-3 802.1Q VLAN Port Settings.....	7-5

Figure 7-4 802.1Q Static VLAN	7-7
Figure 7-5 Static VLAN: Summary Table.....	7-8
Figure 7-6 VID1 Example Screen	7-9
Figure 7-7 Port Based VLAN Setup (All Connected).....	7-11
Figure 7-8 Port Based VLAN Setup (Port Isolation)	7-12
Figure 8-1 Static MAC Forwarding	8-1
Figure 8-2 Static MAC Forwarding: Summary Table	8-2
Figure 9-1 Spanning Tree Protocol: Status.....	9-3
Figure 9-2 Spanning Tree Protocol: Configuring.....	9-5
Figure 10-1 Bandwidth Control	10-1
Figure 12-1 Broadcast Storm Control	12-1
Figure 13-1 Mirroring	13-2
Figure 14-1 Aggregation ID	14-2
Figure 14-2 Link Aggregation: Link Aggregation Protocol Status	14-3
Figure 14-3 Link Aggregation: Configuration	14-4
Figure 15-1 RADIUS Server.....	15-1
Figure 15-2 Port Authentication	15-2
Figure 15-3 Port Authentication: RADIUS	15-2
Figure 15-4 Port Authentication: 802.1x	15-3
Figure 16-1 Port Security	16-2
Figure 17-1 Access Control.....	17-1
Figure 17-2 Console Port Priority	17-1
Figure 17-3 SNMP Management Model	17-2
Figure 17-4 Access Control: SNMP	17-4
Figure 17-5 Access Control: Logins.....	17-5
Figure 17-6 Access Control: Service Access Control.....	17-6
Figure 17-7 Access Control: Remote Management.....	17-7
Figure 18-1 Queuing Method.....	18-2
Figure 18-2 Weighted Round Robin Scheduling Configuration Example	18-3
Figure 18-3 Weighted Round Robin Scheduling Ratio Example	18-3
Figure 19-1 Static Routing	19-1
Figure 19-2 Static Routing: Summary Table	19-2

Figure 20-1 Maintenance	20-1
Figure 20-2 Firmware Upgrade.....	20-1
Figure 20-3 Restore Configuration	20-2
Figure 20-4 Backup Configuration	20-2
Figure 20-5 Confirm Load factory Defaults	20-3
Figure 20-6 Restart Switch After Load Factory Defaults.....	20-3
Figure 20-7 Confirm Restart The Switch.....	20-3
Figure 21-1 Diagnostic.....	21-1
Figure 22-1 Clustering Application Example.....	22-1
Figure 22-2 Cluster Management Status.....	22-2
Figure 22-3 Cluster Member Web Configuration Screen Example	22-3
Figure 22-4 Example: Uploading Firmware to a Cluster Member Switch	22-4
Figure 22-5 Configuring Cluster Management	22-5
Figure 23-1 MAC Table Filtering Flowchart	23-1
Figure 23-2 MAC Table	23-2
Figure 24-1 ARP Table.....	24-2
Figure 25-1 CLI Help: Sample Output.....	25-2
Figure 26-1 sys log disp Command Example	26-1
Figure 26-2 sys version Command Example	26-2
Figure 26-3 sys sw vlan1q vlan list Command Example	26-2
Figure 26-4 sys sw pktcnt Command Example.....	26-3
Figure 26-5 sys sw mac list Command Example	26-4
Figure 26-6 sys cluster status Command Example	26-4
Figure 26-7 sys cluster showMember Command Example.....	26-5
Figure 26-8 sys cluster status Command Example	26-5
Figure 26-9 IP PING Command Example.....	26-6
Figure 26-10 ip route status Command Example.....	26-6
Figure 26-11 ip arp status Command Example	26-6
Figure 26-12 ip dhcp Command Examples.....	26-7
Figure 27-1 Tagged VLAN Configuration and Activation Example	27-2
Figure 27-2 CPU VLAN Configuration and Activation Example	27-2
Figure 27-3 Deleting Default VLAN Example	27-3

Figure 27-4 GARP STATUS Command Example.....	27-3
Figure 27-5 garp timer Command Example.....	27-4
Figure 27-6 garp status Command Example	27-4
Figure 27-7 vlan1q port status Command Example	27-5
Figure 27-8 vlan1q port default vid Command Example	27-5
Figure 27-9 vlan1q port accept Command Example.....	27-6
Figure 27-10 vlan1q port gvrp Command Example.....	27-6
Figure 27-11 vlan1q svlan cpu Command Example.....	27-6
Figure 27-12 Modifying the Static VLAN Example.....	27-7
Figure 27-13 vlan1q svlan delentry Command Example	27-8
Figure 27-14 vlan1q svlan list Command Example	27-9
Figure 27-15 vlan1q svlan list Command Example	27-9
Figure 27-16 vlan1q vlan status Command Example.....	27-10

List of Charts

Chart 1 General Product Specifications	A-1
Chart 2 Performance and Management Specifications.....	A-2
Chart 3 Physical and Environmental Specifications.....	A-3

List of Tables

Table 3-1 ES-2024: Front Panel Ports.....	3-1
Table 3-2 ES-2024 Switches: LED Descriptions.....	3-5
Table 4-1 Navigation Panel Sub-links Overview.....	4-2
Table 4-2 Web Configurator Screens Overview.....	4-3
Table 4-3 Navigation Panel Sub-link Descriptions.....	4-3
Table 5-1 Status.....	5-2
Table 5-2 Status: Port Details.....	5-4
Table 6-1 System Info.....	6-2
Table 6-2 General Setup.....	6-3
Table 6-3 Switch Setup.....	6-6
Table 6-4 IP Setup.....	6-8
Table 6-5 Port Setup.....	6-10
Table 7-1 GARP Terminology.....	7-2
Table 7-2 802.1Q VLAN Status.....	7-3
Table 7-3 802.1Q VLAN Port Settings.....	7-5
Table 7-4 802.1Q Static VLAN.....	7-8
Table 7-5 Static VLAN: Summary Table.....	7-8
Table 7-6 Port Based VLAN Setup.....	7-13
Table 8-1 Static MAC Forwarding.....	8-1
Table 8-2 Static MAC Forwarding: Summary Table.....	8-2
Table 9-1 STP Path Costs.....	9-1
Table 9-2 STP Port States.....	9-2
Table 9-3 Spanning Tree Protocol: Status.....	9-3
Table 9-4 Spanning Tree Protocol: Configuring.....	9-5
Table 10-1 Bandwidth Control.....	10-2
Table 12-1 Broadcast Storm Control.....	12-1
Table 13-1 Mirroring.....	13-2
Table 14-1 Link Aggregation: Link Aggregation Protocol Status.....	14-3
Table 14-2 Link Aggregation: Configuration.....	14-4
Table 15-1 Port Authentication: RADIUS.....	15-2

Dimension ES-2024 Ethernet Switch

Table 15-2 Port Authentication: 802.1x.....	15-4
Table 16-1 Port Security.....	16-2
Table 17-1 Access Control Summary.....	17-2
Table 17-2 SNMP Commands.....	17-3
Table 17-3 SNMP Traps.....	17-3
Table 17-4 Access Control: SNMP.....	17-4
Table 17-5 Access Control: Logins.....	17-5
Table 17-6 Access Control: Service Access Control.....	17-6
Table 17-7 Access Control: Remote Management.....	17-7
Table 18-1 Queuing Method.....	18-2
Table 19-1 Static Routing.....	19-1
Table 19-2 Static Routing: Summary Table.....	19-2
Table 20-1 Filename Conventions.....	20-4
Table 20-2 General Commands for GUI-based FTP Clients.....	20-5
Table 21-1 Diagnostic.....	21-1
Table 22-1 ZyXEL Clustering Management Specifications.....	22-1
Table 22-2 Cluster Management Status.....	22-2
Table 22-3 FTP Upload to Cluster member Example.....	22-4
Table 22-4 Configuring Cluster Management.....	22-5
Table 23-1 MAC Table.....	23-2
Table 24-1 ARP Table.....	24-2
Table 25-1 Command Summary: sys.....	25-2
Table 25-2 Command Summary: sys sw.....	25-6
Table 25-3 Command Summary: exit.....	25-11
Table 25-4 Command Summary: ip.....	25-11
Table 25-5 Command Summary: config.....	25-13

Preface

Congratulations on your purchase from the Dimension series of Ethernet switches.

This preface introduces you to the ES-2024 and discusses the conventions of this User's Guide. It also provides information on other related documentation.

About the ES-2024

The ES-2024 Ethernet switch is a managed switch with features ideally suited in any environment with unshielded twisted pair (UTP) wiring. It can deliver broadband IP services to:

- Multi-tenant unit (MTU) buildings (hotels, motels, resorts, residential multi-dwelling units, office buildings, educational establishments, etc.)
- Public facilities (convention centers, airports, plazas, train stations, etc.)
- Enterprises.

It can also be deployed as a mini-POP (point-of-presence) in a building basement delivering 10/100Mbps data service over Category 5 wiring to each customer.

General Syntax Conventions

- This guide shows you how to configure the switch using the web configurator and CLI commands. See the online HTML help for information on individual web configurator screens.
- Mouse action sequences are denoted using a comma. For example, click **Start, Settings, Control Panel, Network** means first you click **Start**, click or move the mouse pointer over **Settings**, then click or move the mouse pointer over **Control Panel** and finally click (or double-click) **Network**.
- “Enter” means for you to type one or more characters. “Select” or “Choose” means for you to use one of the predefined choices.
- Predefined choices are in **Bold Arial** font.
- Button and field labels, links and screen names in are in **Bold Times New Roman** font.
- For brevity's sake, we will use “e.g.” as shorthand for “for instance”, and “i.e.” as shorthand for “that is” or “in other words” throughout this manual.

Related Documentation

Web Configurator Online HTML help

The online HTML help shows you how to use the web configurator to configure individual screens. More background information can be found in this UG.

ZyXEL Web Site

The ZyXEL download library at www.zyxel.com contains additional support documentation as well as an online glossary of networking terms.

User Guide Feedback

Help us help you. E-mail all User Guide-related comments, questions or suggestions for improvement to techwriters@zyxel.com.tw or send regular mail to The Technical Writing Team, ZyXEL Communications Corp., 6 Innovation Road II, Science-Based Industrial Park, Hsinchu, 300, Taiwan. Thank you.

Part I

Features and Applications

This part acquaints you with the features and applications of the ES-2024.

Chapter 1

Getting to Know the ES-2024

This chapter describes the key features, benefits and applications of the ES-2024.

The ES-2024 is a stand-alone Ethernet switch with 24 10/100Mbps ports, two gigabit (1Gbps or 1000Mbps) ports and two slots for mini GBIC (Gigabit Interface Converter) transceivers.

With its built-in web configurator, managing and configuring the switch is easy. From cabinet management to port-level control and monitoring, you can visually configure and manage your network via the web browser. Just click your mouse instead of typing cryptic command strings. In addition, the switch can also be managed via Telnet, the console port, or third-party SNMP management.

1.1 Features

The next two sections describe the hardware and firmware features of the ES-2024.

1.1.1 Hardware Features

Power

The ES-2024 requires 100~240VAC/0.55A power.

24 10/100 Mbps Fast Ethernet Ports

Connect up to 24 computers or switches to the 10/100Mbps auto-negotiating, automatic cable sensing (auto-MDIX) Ethernet RJ-45 ports. All Ethernet ports support:

- IEEE 802.3/3u/3z/3ab standards
- Back pressure flow control in half duplex mode
- IEEE 802.3x flow control in full duplex mode

Gigabit Ethernet Ports (Two)

The gigabit ports (two) allow the ES-2024 to connect to another WAN switch or daisy-chain to other switches.

Two Slots for Mini GBIC Modules

The mini GBIC (Gigabit Interface Converter) module transceivers allow flexibility in connection options. You can use mini GBIC transceivers for fiber connections to backbone Ethernet switches.

Stacking

Up to eight switches may be stacked.

Console Port

Use the console port for local management of the switch.

Fan

The fan cools the ES-2024 sufficiently to allow reliable operation of the switch even in poorly ventilated rooms or basements.

1.1.2 Firmware Features

IP Protocols

- IP Host (No routing)
- Telnet for configuration and monitoring
- SNMP for management
 - SNMP MIB II (RFC 1213)
 - SNMP v1 RFC 1157
 - Ethernet MIBs RFC 1643
 - Bridge MIBs RFC 1493
 - SMI RFC 1155
 - RMON RFC 1757
 - SNMPv2, SNMPv2c RFC 2674

Management

- Web configurator
- Command-line interface locally via console port or remotely via Telnet
- SNMP

System Monitoring

- System status (link status, rates, statistics counters)
- SNMP
- Fan operation reports and alarms
- Port Mirroring allows you to analyze one port's traffic from another.

Security

- System management password protection
- IEEE 802.1Q VLAN
- Port-based VLAN
- 802.1x Authentication

Port Link Aggregation

The ES-2024 adheres to the 802.3ad standard for static and dynamic port link aggregation.

Bandwidth Control

- The ES-2024 supports rate limiting in 1Kbps increments allowing you to create different service plans

- The ES-2024 supports IGMP snooping enabling group multicast traffic to be only forwarded to ports that are members of that group; thus allowing you to significantly reduce multicast traffic passing through your switch.
- Broadcast storm control

Quality of Service

- Two priority queues so you can ensure mission-critical data gets delivered on time.
- Follows the IEEE 802.1p priority setting standard based on source/destination MAC addresses.

STP (Spanning Tree Protocol) / RSTP (Rapid STP)

(R)STP detects and breaks network loops and provides backup links between switches, bridges or routers. It allows a switch to interact with other (R)STP -compliant switches in your network to ensure that only one path exists between any two stations on the network.

Cluster Management

Cluster management allows you to manage switches through one switch, called the cluster manager.

1.2 Applications

This section shows a few examples of using the ES-2024 in various network environments.

1.2.1 Backbone Application

In this application, the switch is an ideal solution for small networks where rapid growth can be expected in the near future.

The switch can be used standalone for a group of heavy traffic users. You can connect computers directly to the switch's port or connect other switches to the ES-2024.

In this example, all computers connected directly or indirectly to the ES-2024 can share super high-speed applications on the gigabit server.

To expand the network, simply add more networking devices such as switches, routers, firewalls, print servers etc.

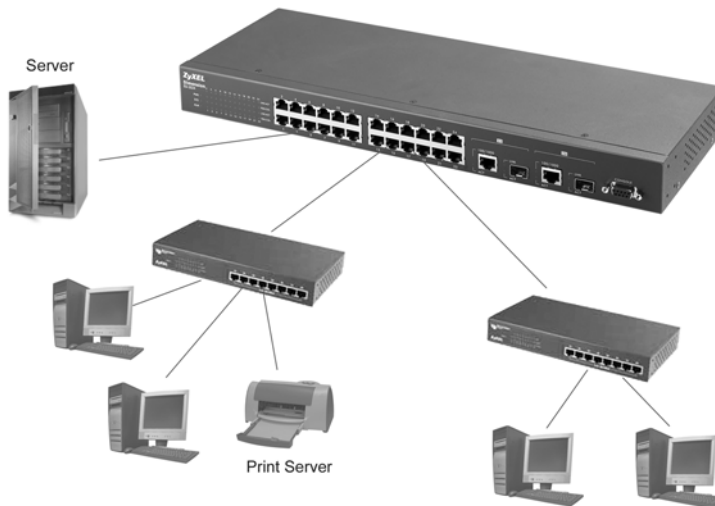

Figure 1-1 Backbone Application

1.2.2 Bridging Example

In this example application the switch is the ideal solution for different company departments to connect to the corporate backbone. It can alleviate bandwidth contention and eliminate server and network bottlenecks. All users that need high bandwidth can connect to high-speed department servers via the switch. You can provide a super-fast connection by selecting from an array of modules compatible with the ES-2024.

Moreover, the switch eases supervision and maintenance by allowing network managers to centralize multiple servers at a single location.

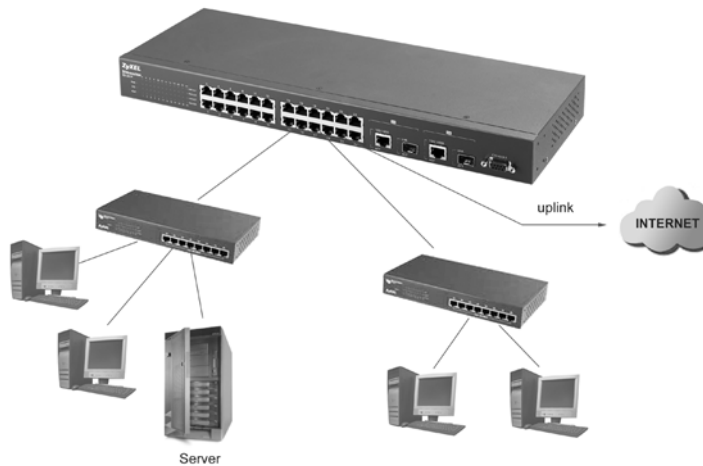

Figure 1-2 Bridging Application

Full-duplex mode operation only applies to point-to-point access (for example, when attaching the switch to a workstation, server, or another switch). When connecting to hubs, use a standard cascaded connection set at half-duplex operation.

1.2.3 High Performance Switched Workgroup Example

The switch is ideal for connecting two power workgroups that need high bandwidth. In the following example, use trunking to connect these two power workgroups.

Switching to higher-speed LANs such as FDDI or ATM is not feasible for most people due to the expense of replacing all existing Ethernet cables and adapter cards, restructuring your network and complex maintenance.

The ES-2024 can provide the same bandwidth as FDDI and ATM at much lower cost while still being able to use existing adapters and switches. Moreover, the current LAN structure can be retained as all ports can freely communicate with each other.

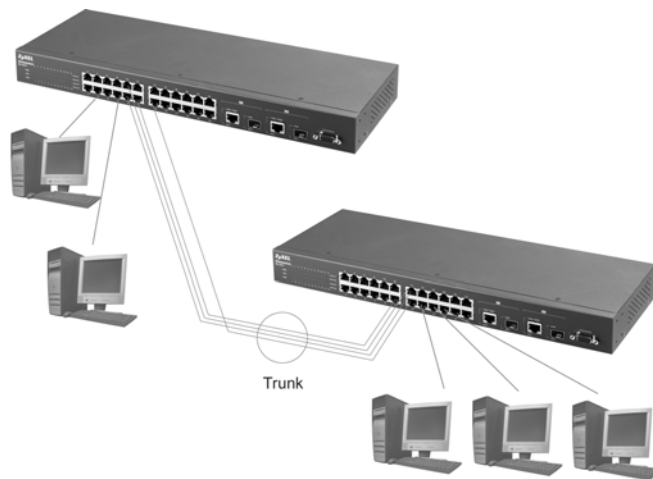

Figure 1-3 High Performance Switched Workgroup Application

1.2.4 IEEE 802.1Q VLAN Application Examples

This section shows a workgroup and a shared server example using 802.1Q tagged VLANs. For more information on VLANs, see the *Switch Setup* and *VLAN Setup* chapters in this User's Guide. A VLAN (Virtual Local Area Network) allows a physical network to be partitioned into multiple logical networks. Stations on a logical network belong to one group. A station can belong to more than one group. With VLAN, a station cannot directly talk to or hear from stations that are not in the same group(s) unless such traffic first goes through a router.

Tag-based VLAN Workgroup Example

Ports in the same VLAN group share the same broadcast domain thus increase network performance through reduced broadcast traffic. VLAN groups can be modified at any time by adding, moving or changing ports without any re-cabling.

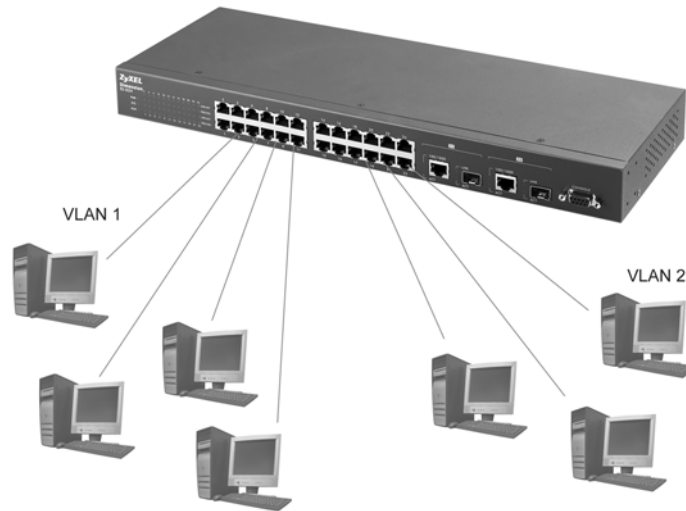

Figure 1-4 VLAN Workgroup Application

VLAN Shared Server Example

Shared resources such as a server can be used by all ports in the same VLAN as the server, as shown in the following example. In this example, only ports that need access to the server need belong to VLAN 3 while they can belong to other VLAN groups too.

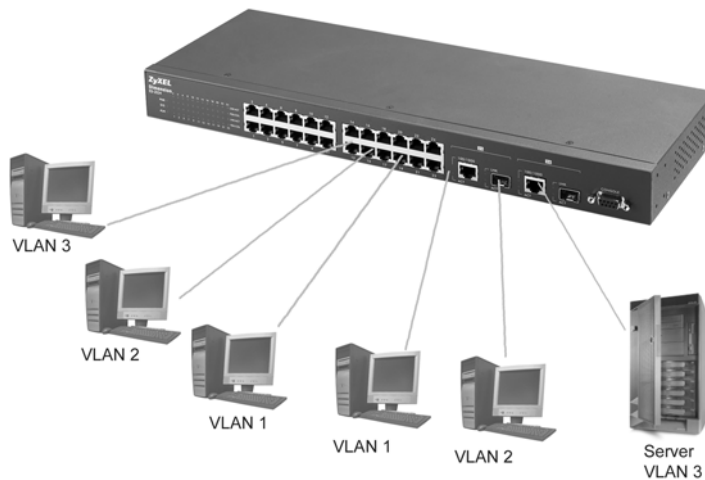

Figure 1-5 Shared Server Using VLAN Example

Part II

Hardware Installation & Connections

This part acquaints you with installation scenarios of the ES-2024, instructs you on how to make the hardware connections including installing/removing modules, and explains the front panel LEDs.

Chapter 2

Hardware Installation

This chapter shows two switch installation scenarios.

2.1 Installation Scenarios

The switch can be placed on a desktop or rack-mounted on a standard EIA rack. Use the rubber feet in a desktop installation and the brackets in a rack-mounted installation.

For proper ventilation, allow at least 4 inches (10 cm) of clearance at the front and 3.4 inches (8 cm) at the back of the switch. This is especially important for enclosed rack installations.

2.1.1 Desktop Installation Procedure

- Step 1.** Make sure the switch is clean and dry.
- Step 2.** Set the switch on a smooth, level surface strong enough to support the weight of the switch and the connected cables. Make sure there is a power outlet nearby.
- Step 3.** Make sure there is enough clearance around the switch to allow air circulation and the attachment of cables and the power cord.
- Step 4.** Remove the adhesive backing from the rubber feet.
- Step 5.** Attach the rubber feet to each corner on the bottom of the switch. These rubber feet help protect the switch from shock or vibration and ensure space between switches when stacking.

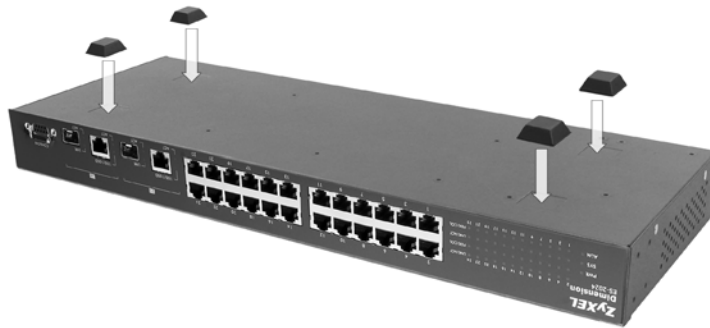

Figure 2-1 Attaching Rubber Feet

Do not block the ventilation holes. Leave space between switches when stacking.

2.1.2 Rack-Mounted Installation

The switch can be mounted on an EIA standard size, 19-inch rack or in a wiring closet with other equipment. Follow the steps below to mount your switch on a standard EIA rack using a rack-mounting kit.

- Step 1.** Align one bracket with the holes on one side of the switch and secure it with the bracket screws smaller than the rack-mounting screws.
- Step 2.** Attach the other bracket in a similar fashion.



Figure 2-2 Attaching Mounting Brackets and Screws

- Step 3.** After attaching both mounting brackets, position the switch in the rack by lining up the holes in the brackets with the appropriate holes on the rack. Secure the switch to the rack with the rack-mounting screws.



Figure 2-3 Mounting the ES to an EIA standard 19-inch rack

Chapter 3

Hardware Connections

This chapter acquaints you with the front and rear panels, shows you how to make the connections, install/remove (optional) modules and explains the LEDs.

3.1 Safety Warnings

- Do not use this product near water, for example, in a wet basement.
- Only a qualified technician should service or disassemble this device.
- To avoid possible eye injury, do not look into an operating fiber-optic module's connectors.

3.2 Front Panel

The following figure shows the front panel of the ES-2024. The front panel contains switch LEDs, 24 RJ-45 Ethernet ports, two RJ-45 gigabit Ethernet ports, two mini GBIC slots and a console port for local switch management.

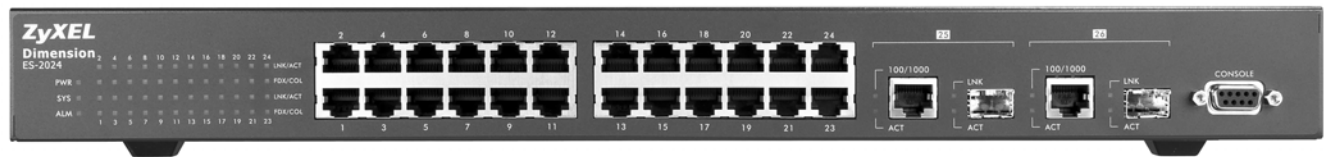

Figure 3-1 ES-2024 Front Panel

Table 3-1 ES-2024: Front Panel Ports

CONNECTOR	DESCRIPTION
1-24	Connect these 10/100 Mbps RJ-45 Ethernet ports to computers, hubs, Ethernet switches or routers.
25 and 26 RJ-45	Connect these 1Gbps Electrical Ethernet ports to high-bandwidth backbone network Ethernet switches or use them to daisy-chain other switches.
25 and 26 mini GBIC slots	Use mini GBIC transceivers in these slots for fiber-optical connections to backbone Ethernet switches.
CONSOLE	The console port is for local configuration of the ES-2024 switch.

3.2.1 10/100Mbps Ethernet Ports

The ES-2024 has 10/100Mbps auto-negotiating, auto-crossover Ethernet ports. In 10/100Mbps Fast Ethernet, the speed can be 10Mbps or 100Mbps and the duplex mode can be half duplex or full duplex (100 Mbps only).

When auto-negotiation is turned on, an Ethernet port on the ES-2024 switch negotiates with the peer automatically to determine the connection speed and duplex mode. If the peer Ethernet port does not support auto-negotiation or

turns off this feature, the ES-2024 switch determines the connection speed by detecting the signal on the cable and using half duplex mode. When the ES-2024 switch's auto-negotiation is turned off, an Ethernet port uses the pre-configured speed and duplex mode when making a connection, thus requiring you to make sure that the settings of the peer Ethernet port are the same in order to connect.

Default Ethernet Negotiation Settings

The factory default negotiation settings for the Ethernet ports on the ES-2024 switch are:

- Speed: Auto
- Duplex: Auto
- Flow control: Off
- Link Aggregation: Disabled

Auto-crossover

All ports are auto-crossover, that is auto-MDIX ports (Media Dependent Interface Crossover), so you may use either a straight through Ethernet cable or crossover Ethernet cable for all Ethernet port connections. Auto-crossover ports automatically sense whether they need to function as crossover or straight ports, so crossover cables can connect both computers and switches/hubs.

3.2.2 Gigabit Ports

These two electrical RJ-45 Ethernet interfaces are for use with the following copper Ethernet cables:

- 100Base-Tx 2 pair UTP Cat. 5, up to 100m
- 1000Base-T 4-pair UTP Cat. 5, up to 100m

Each gigabit port is paired with a mini GBIC slot. The switch uses up to one connection for each pair for a total of two possible gigabit connections (one from each of the two pairs). The switch uses whichever connection first establishes a link. If the connection's link goes down, the switch uses the other connection if it can establish a link.

3.2.3 Mini GBIC Slots

These are slots for mini GBIC (Gigabit Interface Converter) transceivers. A transceiver is a single unit that houses a transmitter and a receiver. The ES-2024 does not come with transceivers. You must use transceivers that comply with the Small Form-factor Pluggable (SFP) Transceiver MultiSource Agreement (MSA). See the SFF committee's INF-8074i specification Rev 1.0 for details.

You can change transceivers while the switch is operating. You can use different transceivers to connect to Ethernet switches with different types of fiber-optic connectors.

To avoid possible eye injury, do not look into an operating fiber-optic module's connectors.

- Type: SFP connection interface
- Connection speed: 1 gigabit per second (Gbps)

Transceiver Installation

Use the following steps to install a mini GBIC transceiver (SFP module).

Step 1. Insert the transceiver into the slot with the exposed section of PCB board facing down.

Step 2. Press the transceiver firmly until it clicks into place.

Step 3. The switch automatically detects the installed transceiver. Check the LEDs to verify that it is functioning properly.

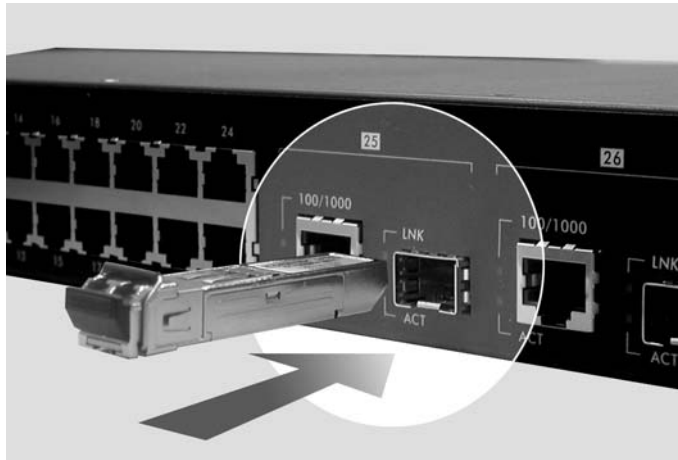

Figure 3-2 Transceiver Installation Example



Figure 3-3 Installed Transceiver

Transceiver Removal

Use the following steps to remove a mini GBIC transceiver (SFP module) from the MSC1000-GBA module.

Step 1. Open the transceiver's latch (latch styles vary).

Step 2. Pull the transceiver out of the slot.

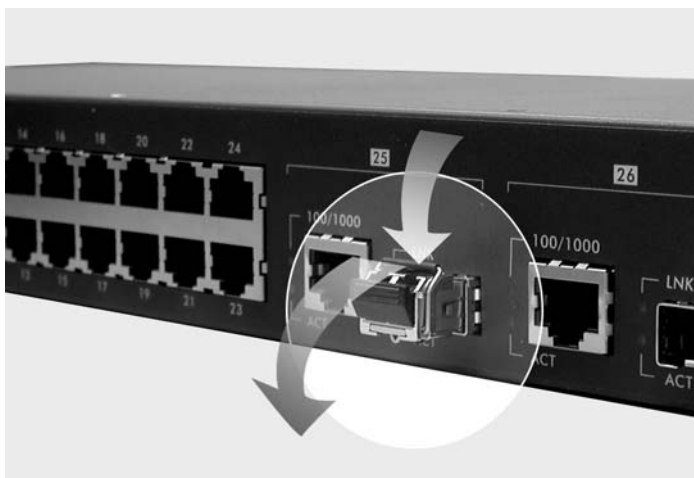

Figure 3-4 Opening the Transceiver's Latch Example

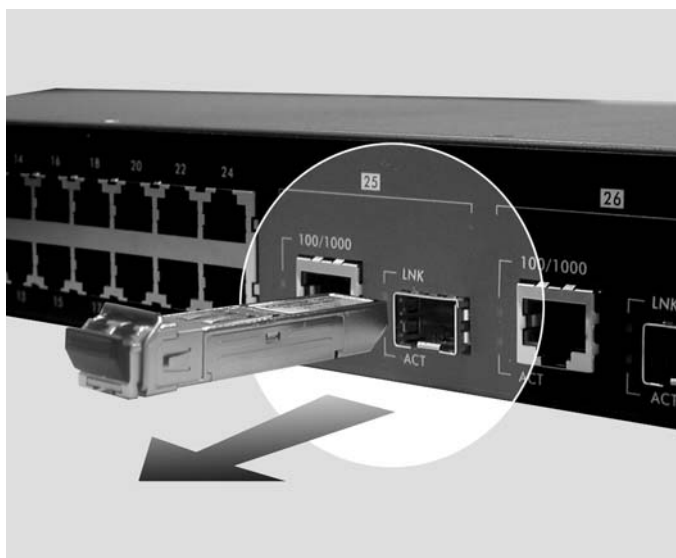

Figure 3-5 Transceiver Removal Example

3.2.4 Console Port

For local management, you can use a computer with terminal emulation software configured to the following parameters:

- VT100 terminal emulation
- 9600 bps
- No parity, 8 data bits, 1 stop bit
- No flow control

Connect the male 9-pin end of the console cable to the console port of the ES-2024 switch. Connect the female end to a serial port (COM1, COM2 or other COM port) of your computer.

3.3 Rear Panel

The following figure shows the rear panel of the ES-2024. The rear panel contains the power receptacle and the fan.



Figure 3-6 ES-2024 Rear Panel

3.3.1 Power Connector

Make sure you are using the correct power source as shown on the panel.

To connect the power to the ES-2024, connect the female end of the supplied power cord to the power receptacle on the rear panel. Connect the other end of the supplied power cord to a 100~240VAC/1.5A power outlet. Make sure that no objects obstruct the airflow of the fan (located on the rear panel).

3.4 Front Panel LEDs

After you connect the power to the switch, view the LEDs to ensure proper functioning of the switch and as an aid in troubleshooting. The front panel LEDs are as follows.

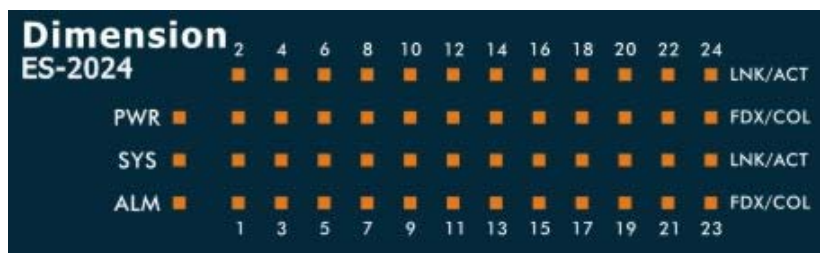

Figure 3-7 Front Panel LEDs

The following table describes the LED indicators on the front panel of an ES-2024 switch.

Table 3-2 ES-2024 Switches: LED Descriptions

LED	COLOR	STATUS	DESCRIPTION
PWR	Green	ON	The system is turned on.
		OFF	The system is off.
SYS	Green	Blinking	The system is rebooting and performing self-diagnostic tests.
		ON	The system is on and functioning properly.
		OFF	The power is off or the system is not ready/malfunctioning.
ALM	Red	ON	There is a hardware failure.
		OFF	The system is functioning normally.

Table 3-2 ES-2024 Switches: LED Descriptions

LED	COLOR	STATUS	DESCRIPTION
LNK/ACT (Ethernet ports 1-24)	Yellow	Blinking	The system is transmitting/receiving to/from a 10 Mbps or 100 Mbps Ethernet network.
		ON	The link to a 10 Mbps or 100 Mbps Ethernet network is up.
		OFF	The link to a 10 Mbps or 100 Mbps Ethernet network is down.
FDX/COL (Ethernet ports 1-24)	Yellow	Blinking	The Ethernet port is negotiating in half-duplex mode and collisions are occurring; the more collisions that occur the faster the LED blinks.
		ON	The Ethernet port is negotiating in full-duplex mode.
		OFF	The Ethernet port is negotiating in half-duplex mode and no collisions are occurring.
100/1000 (Ports 25 and 26, RJ-45)	Yellow	ON	The link to a 100 Mbps Ethernet network is up.
		OFF	The link to a 100 Mbps Ethernet network is down.
	Green	ON	The link to a 1000 Mbps (1Gbps) Ethernet network is up.
		OFF	The link to a 1000 Mbps (1Gbps) Ethernet network is down.
ACT (Ports 25 and 26, RJ-45)	Green	Blinking	The system is transmitting/receiving traffic through this port.
		ON	The link to a 100 or 1000 Mbps Ethernet network is up.
		OFF	The system is not transmitting/receiving traffic through this port.
LNK (Ports 25 and 26, mini GBIC)	Green	ON	The link to a 1000 Mbps (1Gbps) Ethernet network is up.
		OFF	The link to a 1000 Mbps (1Gbps) Ethernet network is down.
ACT (Ports 25 and 26, mini GBIC)	Green	Blinking	The system is transmitting/receiving traffic through this port.
		OFF	The system is not transmitting/receiving traffic through this port.

3.5 Configuring the ES-2024

You may use the embedded web configurator or command line interface to configure the ES-2024. If you're using the web configurator, you need Internet Explorer 5.5 and later or Netscape Navigator 6 and later.

You can access the command line interface using a terminal emulation program on a computer connected to the switch console port (see *section 3.2.4*) or access the switch via an Ethernet port using Telnet.

You can use the “config save” command to save 802.1Q, STP, Cluster and IP configuration changes to non-volatile memory (Flash). These changes are effective after you restart the switch.

However you cannot use “config save” for all other line command configurations. These are saved in volatile memory (DRAM), so are not effective after you restart the switch.

The next part of this guide discusses configuring the ES-2024 using the web configurator.

Part III

Getting Started

This part introduces you to the ES-2024 web configurator including accessing and navigating, a screens overview and how to configure the Basic Setting screens.

Chapter 4

Introducing the Web Configurator

This section introduces the configuration and functions of the Web Configurator.

4.1 Introduction

The embedded web configurator allows you to manage the switch from anywhere through a standard browser such as Microsoft Internet Explorer or Netscape Navigator.

Use Internet Explorer 5.5 and later or Netscape Navigator 6 and later versions.

4.2 System Login

Use the following steps to log into the switch.

- Step 1.** Start your Internet Explorer or Netscape Navigator web browser.
- Step 2.** Type “http://” and the IP address of the switch (for example, the default is 192.168.1.1) in the Location or Address field. Press **Enter**.
- Step 3.** The login screen appears. The default username is **admin** and associated default password is **1234**. The date and time display as shown if you have not configured a time server nor manually entered a time and date in the **General Setup** screen.



Figure 4-1 Web Configurator: login

- Step 4.** Click **OK** to view the first web configurator screen.

4.3 Status Screen

The **Status** screen is the first web configurator screen you see after you log in. The following figure shows the navigating components of a web configurator screen.

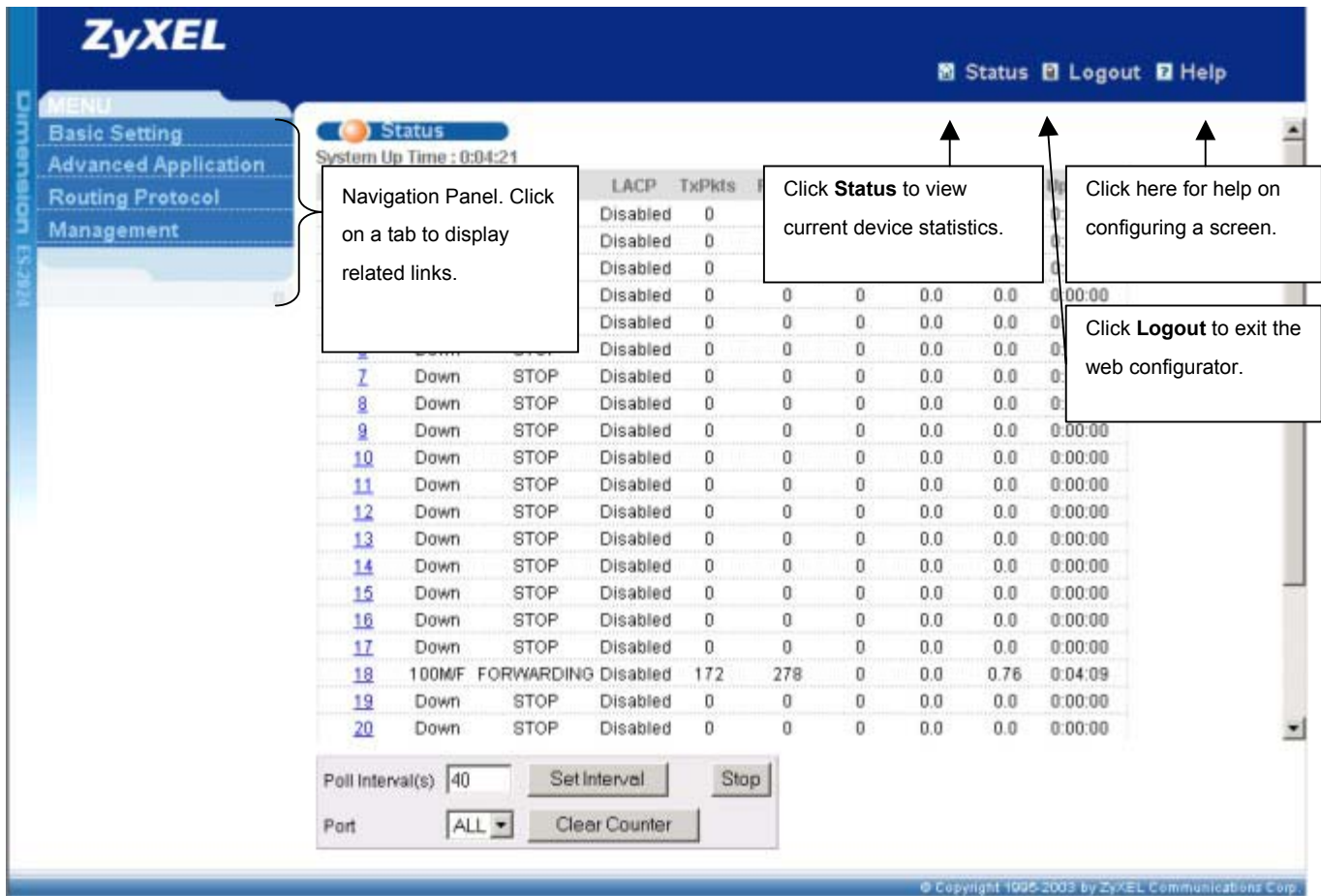

Figure 4-2 Web Configurator Status Screen

In the navigation panel, click a main link to reveal a list of submenu links.

Table 4-1 Navigation Panel Sub-links Overview

BASIC SETTING	ADVANCED APPLICATION	ROUTING PROTOCOL	MANAGEMENT
<p>MENU</p> <ul style="list-style-type: none"> Basic Setting Advanced Application Routing Protocol Management <hr/> <ul style="list-style-type: none"> System Info General Setup Switch Setup IP Setup Port Setup 	<p>MENU</p> <ul style="list-style-type: none"> Basic Setting Advanced Application Routing Protocol Management <hr/> <ul style="list-style-type: none"> VLAN Static MAC Forwarding Spanning Tree Protocol Bandwidth Control Broadcast Storm Control Mirroring Link Aggregation Port Authentication Port Security Access Control Queuing Method 	<p>MENU</p> <ul style="list-style-type: none"> Basic Setting Advanced Application Routing Protocol Management <hr/> <ul style="list-style-type: none"> Static Routing 	<p>MENU</p> <ul style="list-style-type: none"> Basic Setting Advanced Application Routing Protocol Management <hr/> <ul style="list-style-type: none"> Maintenance Diagnostic Cluster Management MAC Table ARP Table

The following table lists the various web configurator screens within the sub-links.

Table 4-2 Web Configurator Screens Overview

BASIC SETTING	ADVANCED APPLICATION	ROUTING PROTOCOL	MANAGEMENT
System Info	VLAN	Static Routing	Maintenance
General Setup	VLAN Port Setting		Firmware Upgrade
Switch Setup	Static VLAN		Restore Configuration
IP Setup	Static MAC Forwarding		Backup Configuration
Port Setup	Spanning Tree Protocol		Load Factory Default
	Status		Reboot System
	Spanning Tree Protocol Configuration		Diagnostic
	Bandwidth Control		Cluster Management
	Broadcast Storm Control		Status
	Mirroring		Cluster Management Configuration
	Link Aggregation		MAC Table
	Link Aggregation Control Protocol Status		ARP Table
	Link Aggregation Configuration		
	Port Authentication		
	RADIUS		
	802.1x		
	Port Security		
	Access Control		
	SNMP		
	Logins		
	Service Access Control		
	Remote Management		
	Queuing Method		

The following table summarizes the sub-links in the navigation panel.

Table 4-3 Navigation Panel Sub-link Descriptions

LABEL	DESCRIPTION
Basic Setting Screens	
System Info	This link takes you to a screen that displays general system and hardware monitoring information.
General Setup	This link takes you to a screen where you can configure general identification information about the switch.
Switch Setup	This link takes you to a screen where you can set up global switch parameters such as VLAN type, MAC address learning, IGMP snooping, GARP and priority queues.

Table 4-3 Navigation Panel Sub-link Descriptions

LABEL	DESCRIPTION
IP Setup	This link takes you to a screen where you can configure the IP address, subnet mask (necessary for switch management) and DNS (domain name server).
Port Setup	This link takes you to screens where you can configure settings for individual switch ports.
Advanced Application	
VLAN	This link takes you to screens where you can configure port-based or 802.1Q VLAN (depending on what you configured in the Switch Setup menu).
Static MAC Forwarding	This link takes you to screens where you can configure static MAC addresses for a port. These static MAC addresses do not age out.
Spanning Tree Protocol	This link takes you to screens where you can configure the STP to prevent network loops.
Bandwidth Control	This link takes you to screens where you can cap the maximum bandwidth allowed for individual ports.
Broadcast Storm Control	This link takes you to a screen to set up broadcast filters.
Mirroring	This link takes you to screens where you can copy traffic from one port or ports to another port in order that you can examine the traffic from the first port without interference
Link Aggregation	This link takes you to a screen where you can logically trunk physical links to form one logical, higher-bandwidth link.
Port Authentication	This link takes you to a screen where you can configure RADIUS (Remote Authentication Dial-In User Service), a protocol for user authentication that allows you to use an external server to validate an unlimited number of users.
Port Security	This link takes you to a screen where you can activate MAC address learning.
Access Control	This link takes you to screens where you can change the system login password and configure SNMP and remote management.
Queuing Method	This link takes you to a screen where you can configure first come first serve, strictly priority queuing or weighted round robin scheduling and associated queue weights.
Routing Protocol	
Static Routing	This link takes you to screens where you can configure static routes. A static route defines how the ES-2024 should forward traffic by configuring the TCP/IP parameters manually.
Management	
Maintenance	This link takes you to screens where you can perform firmware and configuration file maintenance as well as reboot the system.
Diagnostic	This link takes you to screens where you can view system logs and test port(s).
Cluster Management	This link takes you to a screen where you can configure clustering management and view its status.
MAC Table	This link takes you to a screen where you can view the MAC addresses (and types) of devices attached to what ports and VLAN IDs.
ARP Table	This link takes you to a screen where you can view the MAC addresses – IP address resolution table.

4.3.1 Change Your Password

After you log in for the first time, it is recommended you change the default Administrator password in the **Logins** screen. Click **Advanced Application**, **Access Control** and then **Logins** to display the next screen.

Logins Access Control

Administrator

Old Password

New Password

Retype to confirm

Please record your new password whenever you change it. The system will lock you out if you have forgotten your password.

Edit Logins

Login	User Name	Password	Retype to confirm
1	<input type="text"/>	<input type="text"/>	<input type="text"/>
2	<input type="text"/>	<input type="text"/>	<input type="text"/>
3	<input type="text"/>	<input type="text"/>	<input type="text"/>
4	<input type="text"/>	<input type="text"/>	<input type="text"/>

Figure 4-3 Web Configurator: Change Password at Login

4.4 Switch Lockout

You are locked out from managing the switch if another administrator is currently logged in. You must wait until he/she has logged out before you can log in.

Moreover, you could lock yourself (and all others) out from the switch by:

1. Deleting the management VLAN (default is VLAN 1).
2. Deleting all port-based VLANs with the CPU port as a member. The “CPU port” is the management port of the switch.
3. Filtering all traffic to the CPU port.
4. Disabling all ports.
5. Assigning minimum bandwidth to the CPU port. If you limit bandwidth to the CPU port, you may find that the switch performs sluggishly or not at all.

Be careful not to lock yourself and others out of the switch.

4.5 Resetting the Switch

If you lock yourself (and others) from the switch, you will need to reload the factory-default configuration file. Uploading the factory-default configuration file replaces the current configuration file with the factory-default configuration file. This means that you will lose all previous configurations and the speed of the console port will be reset to the default of 9600bps with 8 data bit, no parity, one stop bit and flow control set to none. The password will also be reset to “1234” and the IP address to 192.168.1.1.

4.5.1 Resetting the Switch Via Command

If you know the ES-2024’s password, you can reload the factory-default configuration file via Command Line Interface (CLI) command. Use the following procedure.

- Step 1.** Connect to the console port using a computer with terminal emulation software. See the chapter on hardware connections for details.
- Step 2.** Enter your password.
- Step 3.** Type `sys romreset`.
- Step 4.** Type `y` at the question “Do you want to restore default ROM file(y/n)?”
- Step 5.** The switch restarts.

```
Copyright (c) 1994 - 2004 ZyXEL Communications Corp.
ES-2024> sys romreset
Do you want to restore default ROM file(y/n)?y
OKstore default Romfile.

System Restart! (Console speed will be changed to 9600 bps)

Bootbase Version: V1.00 | 11/20/2003 15:56:56
RAM: Size = 16384 Kbytes
FLASH: Intel 16M

ZyNOS Version: V3.50(LI.0)b2 | 01/29/2004 01:49:37

Press any key to enter debug mode within 3 seconds.
.....
```

Figure 4-4 Resetting the Switch Via Command

The switch is now reinitialized with a default configuration file including the default password of “1234”.

4.5.2 Uploading the Default Configuration File Via Console Port

If you forget the ES-2024 password, you will need to reload the factory-default configuration file via console port. Use the following procedure.

- Step 1.** Connect to the console port using a computer with terminal emulation software. See the chapter on hardware connections for details.
- Step 2.** Disconnect and reconnect the switch’s power to begin a session. When you reconnect the switch’s power, you will see the initial screen.
- Step 3.** When you see the message “Press any key to enter Debug Mode within 3 seconds” press any key to enter debug mode.

Step 4. Type `atlc` after the “Enter Debug Mode” message.

Step 5. Wait for the “Starting XMODEM upload” message before activating XMODEM upload on your terminal.

Step 6. After a successful configuration file upload, type `atgo` to restart the switch.

```

Bootbase Version: V1.0 | 04/25/2003 10:01:06
RAM: Size = 32768 Kbytes
FLASH: Intel 32M

ZyNOS Version: V3.50(DU.0)b6 | 07/11/2003 18:00:29

Press any key to enter debug mode within 3 seconds.
.....
Enter Debug Mode
ES-2024> atlc

Starting XMODEM upload (CRC mode)....
CCCCCCCCCCCCCCCC
Total 262144 bytes received.

Erasing..
.....
OK

```

Figure 4-5 Uploading the Default Configuration File Via Console Port

The switch is now reinitialized with a default configuration file including the default password of “1234”.

4.5.3 Logging Out of the Web Configurator

Click **Logout** in a screen to exit the web configurator. You have to log in with your password again after you log out. This is recommended after you finish a management session both for security reasons and so as you don’t lock out other switch administrators.



Figure 4-6 Web Configurator: Logout Screen

4.5.4 Help

The web configurator’s online help has descriptions of individual screens and some supplementary information. Click the **Help** link from a web configurator screen to view an online help description of that screen.

Chapter 5

System Status and Port Details

This chapter describes the system status (web configurator home page) and port details screens.

5.1 About System Statistics and Information

The home screen of the web configurator displays a port statistical summary with links to each port showing statistical details.

5.2 Port Status Summary

To view the port statistics, click **Status** in any web configurator screen to display the **Status** screen as shown next.

The screenshot shows the 'Status' page with a 'System Up Time : 0:22:19' indicator. Below is a table with 10 columns: Port, Link, State, LACP, TxPkts, RxPkts, Errors, Tx KB/s, Rx KB/s, and Up Time. Port 2 is the only one in a 'FORWARDING' state, while all others are 'STOP'. At the bottom, there are controls for 'Poll Interval(s)' (set to 40), 'Set Interval', 'Stop', 'Port' (set to 1), and 'Clear Counter'.

Port	Link	State	LACP	TxPkts	RxPkts	Errors	Tx KB/s	Rx KB/s	Up Time
1	Down	STOP	Disabled	0	0	0	0.0	0.0	0:00:00
2	100M/F	FORWARDING	Disabled	185	173	0	0.0	0.0	0:21:56
3	Down	STOP	Disabled	0	0	0	0.0	0.0	0:00:00
4	Down	STOP	Disabled	0	0	0	0.0	0.0	0:00:00
5	Down	STOP	Disabled	0	0	0	0.0	0.0	0:00:00
6	Down	STOP	Disabled	0	0	0	0.0	0.0	0:00:00
7	Down	STOP	Disabled	0	0	0	0.0	0.0	0:00:00
8	Down	STOP	Disabled	0	0	0	0.0	0.0	0:00:00
9	Down	STOP	Disabled	0	0	0	0.0	0.0	0:00:00
10	Down	STOP	Disabled	0	0	0	0.0	0.0	0:00:00
11	Down	STOP	Disabled	0	0	0	0.0	0.0	0:00:00
12	Down	STOP	Disabled	0	0	0	0.0	0.0	0:00:00
13	Down	STOP	Disabled	0	0	0	0.0	0.0	0:00:00
14	Down	STOP	Disabled	0	0	0	0.0	0.0	0:00:00
15	Down	STOP	Disabled	0	0	0	0.0	0.0	0:00:00
16	Down	STOP	Disabled	0	0	0	0.0	0.0	0:00:00
17	Down	STOP	Disabled	0	0	0	0.0	0.0	0:00:00
18	Down	STOP	Disabled	0	0	0	0.0	0.0	0:00:00
19	Down	STOP	Disabled	0	0	0	0.0	0.0	0:00:00

Poll Interval(s)
 Port

Figure 5-1 Port Status Summary

The following table describes the labels in this screen.

Table 5-1 Status

LABEL	DESCRIPTION
System up Time	This field shows how long the system has been running since the last time it was started.
Port	This identifies the Ethernet port. Click a port number to display the Port Details screen (refer to <i>Section 5.2.1</i>).
Link	This field displays the speed (either 10M for 10Mbps, 100M for 100Mbps or another value depending on the uplink module being used) and the duplex (F for full duplex or H for half).
State	This field displays the STP state of the port. See the <i>Spanning Tree Protocol</i> chapter for details on STP port states.
LACP	This fields displays whether the Link Aggregation Control Protocol (LACP) has been enabled on the port.
TxPkts	This field shows the number of transmitted frames on this port.
RxPkts	This field shows the number of received frames on this port.
Errors	This field shows the number of received errors on this port.
Tx KB/s	This field shows the number of kilobytes per second transmitted on this port.
Rx KB/s	This field shows the number of kilobytes per second received on this port.
Up Time	This field shows the total amount of time in hours, minutes and seconds the port has been up.
Poll Interval(s)	The text box displays how often (in seconds) this screen refreshes. You may change the refresh interval by typing a new number in the text box and then clicking Set Interval .
Stop	Click Stop to halt system statistic polling.
Clear Counter	Select a port from the Port drop-down list box and then click Clear Counter to erase the recorded statistical information for that port.

5.2.1 Port Details

Click a number in the **Port** column in the **Status** screen to display individual port statistics. Use this screen to check status and detailed performance data about an individual port on the switch.

Port Details		Status
Port Info	Port NO.	2
	Link	100M/H
	Status	FORWARDING
	LACP	Disabled
	TxPkts	505
	RxPkts	177536
	Errors	2036
	Tx KBs/s	0.65
	Rx KBs/s	5.488
	Up Time	1:08:41
TX Packet	Octet	256089
	Unicast	505
RX Packet	Octet	34154273
	64 Byte	90665
	65-127 Byte	36120
	128-255 Byte	30344
	256-511 Byte	4303
	512-1023 Byte	8115
	1024-1518 Byte	7989
	Multicast	4563
	Broadcast	112313
TX Collision	Single	0
	Multiple	0
	Excessive	0
	Late	0
RX Error	FCS	0
	OverSize	0
	Align	0
	Jabber	0
	Fragment	2036
	UnderSize	0
Dropped Packet	All	63323
	FwdLkup	63323
	InOverrun	0
	TxUnderrun	0
	OutQueueLife	0
	OutQueueLen	0

Poll Interval(s)

Figure 5-2 Status: Port Details

The following table describes the labels in this screen.

Table 5-2 Status: Port Details

LABEL	DESCRIPTION
Port Info	
Port NO.	This field identifies the Ethernet port described in this screen.
Link	This field shows whether the Ethernet connection is down, and the speed/duplex mode.
Status	This field shows the training state of the ports. The states are FORWARDING (forwarding), which means the link is functioning normally or STOP (the port is stopped to break a loop or duplicate path).
LACP	This field shows if LACP is enabled on this port or not.
TxPkts	This field shows the number of transmitted frames on this port
RxPkts	This field shows the number of received frames on this port
Errors	This field shows the number of received errors on this port.
Tx KB/s	This field shows the number kilobytes per second transmitted on this port.
Rx KB/s	This field shows the number of kilobytes per second received on this port.
Up Time	This field shows the total amount of time the connection has been up.
Tx Packet The following fields display detailed information about frames transmitted.	
Octet	This field shows the number of good octets (unicast, multicast and broadcast) transmitted.
Unicast	This field shows the number of good unicast frames transmitted.
Rx Packet The following fields display detailed information about frames received.	
Octet	This field shows the number of good octets received.
64 Byte	This field shows the number of frames (including bad frames) received that were 64 octets in length.
65-127 Byte	This field shows the number of frames (including bad frames) received that were between 65 and 127 octets in length.
128-255 Byte	This field shows the number of frames (including bad frames) received that were between 128 and 255 octets in length.
256-511 Byte	This field shows the number of frames (including bad frames) received that were between 256 and 511 octets in length.
512-1023 Byte	This field shows the number of frames (including bad frames) received that were between 512 and 1023 octets in length.
1024-1518 Byte	This field shows the number of frames (including bad frames) received that were between 1024 and 1518 octets in length.

Table 5-2 Status: Port Details

LABEL	DESCRIPTION
>1518 Byte	This field shows the number of frames (including bad frames) transmitted that were greater than 1518 octets in length.
Multicast	This field shows the number of good multicast frames received.
Broadcast	This field shows the number of good broadcast frames received.
TX Collision The following fields display information on collisions while transmitting.	
Single	This is a count of successfully transmitted frames for which transmission is inhibited by exactly one collision.
Multiple	This is a count of successfully transmitted frames for which transmission was inhibited by more than one collision.
Excessive	This is a count of frames for which transmission failed due to excessive collisions. Excessive collision is defined as the number of maximum collisions before the retransmission count is reset.
Late	This is the number of times a late collision is detected, that is, after 512 bits of the frame have already been transmitted.
RX Error The following fields display detailed information about frames received that were in error.	
FCS	This field shows the number of frames received of the proper size but with CRC error(s) and a non-integral number of octets.
Oversize	This field shows the number of frames received that were bigger than the maximum frame size.
Align	This field shows the number of frames received of proper size but with CRC error(s) and a non-integral number of octets.
Jabber	This field shows the number of frames received that were greater than the maximum octets (specified for the system by the configuration software) long and with either CRC or alignment error(s).
Fragment	This field shows the number of packets received that were less than 64 octets long, and with either CRC (Cyclic Redundant Check) or alignment error(s).
UnderSize	This field shows the number of frames received that were less than 64 octets long and without CRC error(s) or alignment error(s).
Dropped Packet The following fields provide information about frames that were dropped.	
All	This field shows the total number of frames that the switch dropped.
FwdLkup	This field shows the number of unicast packets that the switch dropped after forwarding table lookup.
InOverrun	This field shows the number of packets that the switch dropped because of an input FIFO overrun.

Table 5-2 Status: Port Details

LABEL	DESCRIPTION
TxUnderrun	This field shows the number of packets that the switch dropped because of an output buffer underrun.
OutQueLife	This field shows the number of packets that the switch dropped because the queued time was longer than the lifetime setting.
OutQueLen	This field shows the number of packets in the switch's output queue, awaiting transmission.
Poll Interval(s)	The text box displays how often (in seconds) this screen refreshes. You may change the refresh interval by typing a new number in the text box and then clicking Set Interval .
Stop	Click Stop to stop port statistic polling.

Chapter 6

Basic Setting

*This chapter describes how to configure the **System Info**, **General Setup**, **Switch Setup**, **IP Setup** and **Port Setup** screens.*

6.1 Introducing The Basic Setting Screens

The **System Info** screen displays general switch information (such as firmware version number) and hardware polling information (such as fan status). The **General Setup** screen allows you to configure general switch identification information. The **General Setup** screen also allows you to set the system time manually or get the current time and date from an external server when you turn on your switch. The real time is then displayed in the switch logs. The **Switch Setup** screen allows you to set up and configure global switch features. The **IP Setup** screen allows you to configure a switch IP address, subnet mask and DNS (domain name server) for management purposes.

6.2 System Information

In the navigation panel, click **Basic Setting** and then **System Info** to display the screen as shown. You can check the firmware version number and monitor the switch fan status in this screen.

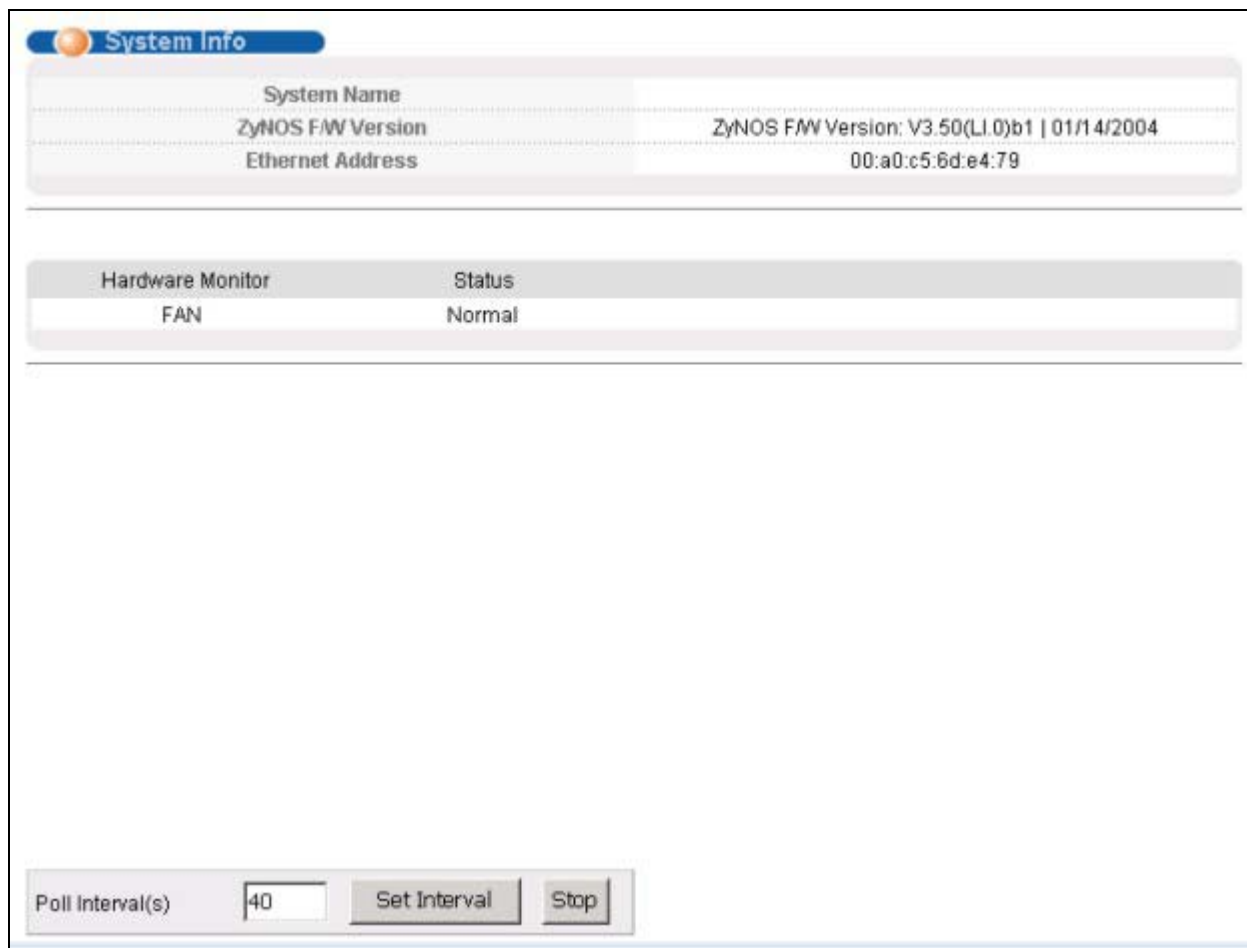

Figure 6-1 System Info

The following table describes the labels in this screen.

Table 6-1 System Info

LABEL	DESCRIPTION
System Name	This field displays the switch 's model name.
ZyNOS F/W Version	This field displays the version number of the switch 's current firmware including the date created.
Ethernet Address	This field refers to the Ethernet MAC (Media Access Control) address of the switch.
Hardware Monitor	
FAN	A properly functioning fan is an essential component (along with a sufficiently ventilated, cool operating environment) in order for the device to stay within the temperature threshold. The switch is capable of detecting and reporting if the fan is rotating. “Normal” displays when the fan is rotating. “Error” displays when the fan has stopped.
Poll Interval(s)	The text box displays how often (in seconds) this screen refreshes. You may change the refresh interval by typing a new number in the text box and then clicking Set Interval .
Stop	Click Stop to halt statistic polling.

6.3 General Setup

Click **Basic Setting** and **General Setup** in the navigation panel to display the screen as shown.

General Setup

System Name: ES-2024

Location:

Contact Person's Name:

Use Time Server when Bootup: None

Time Server IP Address: 0.0.0.0

Current Time: 01 : 13 : 13

New Time (hh:mm:ss): 01 : 13 : 13

Current Date: 2000 - 01 - 01

New Date (yyy-mm-dd): 2000 - 01 - 01

Time Zone: UTC

It will take 60 seconds if time server is unreachable.

Apply Cancel

Figure 6-2 General Setup

The following table describes the labels in this screen.

Table 6-2 General Setup

LABEL	DESCRIPTION
System Name	Choose a descriptive name for identification purposes. This name consists of up to 32 printable characters; spaces are not allowed.
Location	Enter the geographic location (up to 30 characters) of your switch.
Contact Person's Name	Enter the name (up to 30 characters) of the person in charge of this switch.

Table 6-2 General Setup

LABEL	DESCRIPTION
Use Time Server When Bootup	<p>Enter the time service protocol that a timeserver sends when you turn on the switch. Not all timeservers support all protocols, so you may have to use trial and error to find a protocol that works. The main differences between them are the time format.</p> <p>Daytime (RFC 867) format is day/month/year/time zone of the server.</p> <p>Time (RFC-868) format displays a 4-byte integer giving the total number of seconds since 1970/1/1 at 0:0:0.</p> <p>NTP (RFC-1305) is similar to Time (RFC-868).</p> <p>None is the default value. Enter the time manually. Each time you turn on the switch, the time and date will be reset to 2000-1-1 0:0.</p>
Time Server IP Address	<p>Enter the IP address (or URL if you configure a domain name server in the IP Setup screen) of your timeserver. The switch searches for the timeserver for up to 60 seconds. If you select a timeserver that is unreachable, then this screen will appear locked for 60 seconds. Please wait.</p>
Current Time	<p>This field displays the time you open this menu (or refresh the menu).</p>
New Time (hh:min:ss)	<p>Enter the new time in hour, minute and second format. The new time then appears in the Current Time field after you click Apply.</p>
Current Date	<p>This field displays the date you open this menu.</p>
New Date (yyyy-mm-dd)	<p>Enter the new date in year, month and day format. The new date then appears in the Current Date field after you click Apply.</p>
Time Zone	<p>Select the time difference between UTC (Universal Time Coordinated, formerly known as GMT, Greenwich Mean Time) and your time zone from the drop-down list box.</p>
Apply	<p>Click Apply to save the settings.</p>
Cancel	<p>Click Cancel to start configuring the screen again.</p>

6.4 Introduction to VLANs

A VLAN (Virtual Local Area Network) allows a physical network to be partitioned into multiple logical networks. Devices on a logical network belong to one group. A device can belong to more than one group. With VLAN, a device cannot directly talk to or hear from devices that are not in the same group(s); the traffic must first go through a router.

In MTU (Multi-Tenant Unit) applications, VLAN is vital in providing isolation and security among the subscribers. When properly configured, VLAN prevents one subscriber from accessing the network resources of another on the same LAN, thus a user will not see the printers and hard disks of another user in the same building.

VLAN also increases network performance by limiting broadcasts to a smaller and more manageable logical broadcast domain. In traditional switched environments, all broadcast packets go to each and every individual port. With VLAN, all broadcasts are confined to a specific broadcast domain.

Note that VLAN is unidirectional; it only governs outgoing traffic.

See the *VLAN* chapter for information on port-based and 802.1Q tagged VLANs.

6.5 IGMP Snooping

IGMP (Internet Group Multicast Protocol) is a session-layer protocol used to establish membership in a multicast group - it is not used to carry user data. Refer to *RFC 1112* and *RFC 2236* for information on IGMP versions 1 and 2 respectively.

A layer-2 switch can passively snoop on IGMP Query, Report and Leave (IGMP version 2) packets transferred between IP multicast routers/switches and IP multicast hosts to learn the IP multicast group membership. It checks IGMP packets passing through it, picks out the group registration information, and configures multicasting accordingly.

Without IGMP snooping, multicast traffic is treated in the same manner as broadcast traffic, that is, it is forwarded to all ports. With IGMP snooping, group multicast traffic is only forwarded to ports that are members of that group. IGMP Snooping generates no additional network traffic, allowing you to significantly reduce multicast traffic passing through your switch.

6.6 Switch Setup Screen

Click **Basic Setting** and then **Switch Setup** in the navigation panel display the screen as shown. The VLAN setup screens change depending on whether you choose **802.1Q** or **Port Based** in the **VLAN Type** field in this screen. Refer to the chapter on VLANs.

Switch Setup

VLAN Type: 802.1Q Port Based

IGMP Snooping: Active

MAC Address Learning: Aging Time: seconds

GARP Timer: Join Timer: milliseconds
 Leave Timer: milliseconds
 Leave All Timer: milliseconds

Priority Queue Assignment:

level7	High
level6	High
level5	High
level4	High
level3	High
level2	Low
level1	Low
level0	High

Apply Cancel

Figure 6-3 Switch Setup

The following table describes the labels in this screen.

Table 6-3 Switch Setup

LABEL	DESCRIPTION
VLAN Type	Choose 802.1Q or Port Based from the drop-down list box. The VLAN Setup screen changes depending on whether you choose 802.1Q VLAN Type or Port Based VLAN Type in this screen. See <i>Section 6.4</i> and the <i>VLAN</i> chapter for more information on VLANs.
IGMP Snooping	Select Active to enable IGMP snooping have group multicast traffic only forwarded to ports that are members of the VLAN, significantly reducing multicast traffic passing through your switch. See <i>Section 6.5</i> for more information on IGMP snooping.
MAC Address Learning	MAC address learning reduces outgoing traffic broadcasts. For MAC address learning to occur on a port, the port must be active.
Aging Time	Enter a time from 10 to 765 seconds. This is how long all dynamically learned MAC addresses remain in the MAC address table before they age out (and must be relearned).

Table 6-3 Switch Setup

LABEL	DESCRIPTION
	<p>GARP Timer: Switches join VLANs by making a declaration. A declaration is made by issuing a Join message using GARP. Declarations are withdrawn by issuing a Leave message. A Leave All message terminates all registrations. GARP timers set declaration timeout values. See the chapter on VLAN setup for more background information.</p>
Join Timer	<p>Join Timer sets the duration of the Join Period timer for GVRP in milliseconds. Each port has a Join Period timer. The allowed Join Time range is between 100 and 65535 milliseconds; the default is 200 milliseconds. See the chapter on VLAN setup for more background information.</p>
Leave Timer	<p>Leave Timer sets the duration of the Leave Period timer for GVRP in milliseconds. Each port has a single Leave Period timer. Leave Time must be two times larger than Join Timer; the default is 600 milliseconds.</p>
Leave All Timer	<p>Leave All Timer sets the duration of the Leave All Period timer for GVRP in milliseconds. Each port has a single Leave All Period timer. Leave All Timer must be larger than Leave Timer; the default is 1000 milliseconds.</p>
<p>Priority Queue Assignment</p> <p>IEEE 802.1p defines up to 8 separate traffic types by inserting a tag into a MAC-layer frame that contains bits to define class of service. Frames without an explicit priority tag are given the default priority of the ingress port. Use the next two fields to configure the priority level-to-physical queue mapping.</p> <p>The switch has 2 physical queues that you can map to the 8 priority levels. On the switch, traffic assigned to higher index queues gets through faster while traffic in lower index queues is dropped if the network is congested.</p> <p>See also Queuing Method and Priority in Port Setup for related information.</p>	
<p>Priority Level (The following descriptions are based on the traffic types defined in the IEEE 802.1d standard (which incorporates the 802.1p).</p>	
Level 7	Typically used for network control traffic such as router configuration messages.
Level 6	Typically used for voice traffic that is especially sensitive to jitter (jitter is the variations in delay).
Level 5	Typically used for video that consumes high bandwidth and is sensitive to jitter.
Level 4	Typically used for controlled load, latency-sensitive traffic such as SNA (Systems Network Architecture) transactions.
Level 3	Typically used for “excellent effort” or better than best effort and would include important business traffic that can tolerate some delay.
Level 2	This is for “spare bandwidth”.
Level 1	This is typically used for non-critical “background” traffic such as bulk transfers that are allowed but that should not affect other applications and users.
Level 0	Typically used for best-effort traffic.
Apply	Click Apply to save your changes back to the switch.
Cancel	Click Cancel to begin configuring this screen afresh.

6.7 IP Setup

Use the **IP Setup** screen to configure the default gateway device, the default domain name server and add IP domains.

To set the default gateway device and the domain name server on the switch, click **IP Setup** in the navigation panel and set the related fields. The default gateway specifies the IP address of the default gateway (next hop) for outgoing traffic.

The following table describes the labels in this screen.

Table 6-4 IP Setup

LABEL	DESCRIPTION
DHCP Client	Select this option if you have a DHCP server that can assign the switch an IP address, subnet mask, a default gateway IP address and a domain name server IP address automatically.
Static IP Address	Select this option if you don't have a DHCP server or if you wish to assign static IP address information to the switch. You need to fill in the following fields when you select this option.
IP Address	Enter the IP address of your switch in dotted decimal notation for example 192.168.1.1.
IP Subnet Mask	Enter the IP subnet mask of your switch in dotted decimal notation for example 255.255.255.0.
Default Gateway	Enter the IP address of the default outgoing gateway in dotted decimal notation, for example 192.168.1.254.
Domain Name Server	DNS (Domain Name System) is for mapping a domain name to its corresponding IP address and vice versa. Enter a domain name server IP address in order to be able to use a domain name instead of an IP address.

Table 6-4 IP Setup

LABEL	DESCRIPTION
Management VID	Enter the VLAN identification number associated with the switch IP address. Management VLAN ID is the VLAN ID of the CPU and is used for management only. The default is "1". All ports, by default, are fixed members of this "management VLAN" in order to manage the device from any port. If a port is not a member of this VLAN, then users on that port cannot access the device. To access the switch make sure the port that you are connected to is a member of Management VLAN.
Apply	Click Apply to save your changes back to the switch.
Cancel	Click Cancel to begin configuring the fields again.

6.8 Port Setup

Click **Basic Setting** and then **Port Setup** in the navigation panel to enter the port configuration screen. You may configure any of the switch ports including uplink ports.

Port	Active	Name	Type	Speed / Duplex	Flow Control	Priority
1	<input type="checkbox"/>	port00	10/100M	Auto	<input type="checkbox"/>	None
2	<input type="checkbox"/>	port01	10/100M	Auto	<input type="checkbox"/>	None
3	<input type="checkbox"/>	port02	10/100M	Auto	<input type="checkbox"/>	None
4	<input type="checkbox"/>	port03	10/100M	Auto	<input type="checkbox"/>	None
5	<input type="checkbox"/>	port04	10/100M	Auto	<input type="checkbox"/>	None
6	<input type="checkbox"/>	port05	10/100M	Auto	<input type="checkbox"/>	None
7	<input type="checkbox"/>	port06	10/100M	Auto	<input type="checkbox"/>	None
8	<input type="checkbox"/>	port07	10/100M	Auto	<input type="checkbox"/>	None
9	<input type="checkbox"/>	port08	10/100M	Auto	<input type="checkbox"/>	None
10	<input type="checkbox"/>	port09	10/100M	Auto	<input type="checkbox"/>	None
11	<input type="checkbox"/>	port10	10/100M	Auto	<input type="checkbox"/>	None
12	<input type="checkbox"/>	port11	10/100M	Auto	<input type="checkbox"/>	None
13	<input type="checkbox"/>	port12	10/100M	Auto	<input type="checkbox"/>	None
14	<input type="checkbox"/>	port13	10/100M	Auto	<input type="checkbox"/>	None
15	<input type="checkbox"/>	port14	10/100M	Auto	<input type="checkbox"/>	None
16	<input type="checkbox"/>	port15	10/100M	Auto	<input type="checkbox"/>	None
17	<input type="checkbox"/>	port16	10/100M	Auto	<input type="checkbox"/>	None
18	<input type="checkbox"/>	port17	10/100M	Auto	<input type="checkbox"/>	None
19	<input type="checkbox"/>	port18	10/100M	Auto	<input type="checkbox"/>	None
20	<input type="checkbox"/>	port19	10/100M	Auto	<input type="checkbox"/>	None
21	<input type="checkbox"/>	port20	10/100M	Auto	<input type="checkbox"/>	None
22	<input type="checkbox"/>	port21	10/100M	Auto	<input type="checkbox"/>	None
23	<input type="checkbox"/>	port22	10/100M	Auto	<input type="checkbox"/>	None
24	<input type="checkbox"/>	port23	10/100M	Auto	<input type="checkbox"/>	None
25	<input type="checkbox"/>	port24	100/1000M	Auto	<input type="checkbox"/>	None
26	<input type="checkbox"/>	port25	100/1000M	Auto	<input type="checkbox"/>	None

Apply Cancel

Figure 6-4 Port Setup

The following table describes the fields in this screen.

Table 6-5 Port Setup

LABEL	DESCRIPTION
Port	This is the port index number.
Active	Select this check box to enable a port. The factory default for all ports is enabled. A port must be enabled for data transmission to occur.

Table 6-5 Port Setup

LABEL	DESCRIPTION
Name	Enter a descriptive name that identifies this port.
Type	This field displays 10/100M for an Ethernet/Fast Ethernet connection and 1000M for gigabit connections.
Speed/Duplex	<p>Select the speed and the duplex mode of the Ethernet connection on this port. Choices are Auto, 10M/Half Duplex, 10M/Full Duplex, 100M/Half Duplex, 100M/Full Duplex and 1000M/Full Duplex (for gigabit ports only).</p> <p>Selecting Auto (auto-negotiation) makes one Ethernet port able to negotiate with a peer automatically to obtain the connection speed and duplex mode that both ends support. When auto-negotiation is turned on, an Ethernet port on the switch negotiates with the peer automatically to determine the connection speed and duplex mode. If the peer Ethernet port does not support auto-negotiation or turns off this feature, the switch determines the connection speed by detecting the signal on the cable and using half duplex mode. When the switch's auto-negotiation is turned off, an Ethernet port uses the pre-configured speed and duplex mode when making a connection, thus requiring you to make sure that the settings of the peer Ethernet port are the same in order to connect.</p>
Flow Control	<p>A concentration of traffic on a port decreases port bandwidth and overflows buffer memory causing packet discards and frame losses. Flow Control is used to regulate transmission of signals to match the bandwidth of the receiving port.</p> <p>The switch uses IEEE802.3x flow control in full duplex mode and backpressure flow control in half duplex mode.</p> <p>IEEE802.3x flow control is used in full duplex mode to send a pause signal to the sending port, causing it to temporarily stop sending signals when the receiving port memory buffers fill.</p> <p>Back Pressure flow control is typically used in half duplex mode to send a "collision" signal to the sending port (mimicking a state of packet collision) causing the sending port to temporarily stop sending signals and resend later. Select Flow Control to enable it.</p>
Priority	The switch uses this priority value for incoming frames without an IEEE 802.1p priority queue tag. The switch uses this priority value internally and does not add an IEEE 802.1p priority tag. See Priority Queue Assignment in <i>Table 6-3</i> for more information. See also Priority Queue Assignment in Switch Setup and Queuing Method for related information.
Apply	Click Apply to save your changes back to the switch.
Cancel	Click Cancel to begin configuring this screen afresh.

Part IV

Advanced Application 1

This part shows you how to configure the VLAN, Static MAC Forwarding, STP and Bandwidth Control Advanced Application screens.

Chapter 7

VLAN

*The type of screen you see here depends on the **VLAN Type** you selected in the **Switch Setup** screen. This chapter shows you how to configure 802.1Q tagged and port-based VLANs. See the **General, Switch and IP Setup** chapter for more information.*

7.1 Introduction to IEEE 802.1Q Tagged VLAN

Tagged VLAN uses an explicit tag (VLAN ID) in the MAC header to identify the VLAN membership of a frame across bridges - they are not confined to the switch on which they were created. The VLANs can be created statically by hand or dynamically through GVRP. The VLAN ID associates a frame with a specific VLAN and provides the information that switches need to process the frame across the network. A tagged frame is four bytes longer than an untagged frame and contains two bytes of TPID (Tag Protocol Identifier, residing within the type/length field of the Ethernet frame) and two bytes of TCI (Tag Control Information, starts after the source address field of the Ethernet frame).

The CFI (Canonical Format Indicator) is a single-bit flag, always set to zero for Ethernet switches. If a frame received at an Ethernet port has a CFI set to 1, then that frame should not be forwarded as it is to an untagged port. The remaining twelve bits define the VLAN ID, giving a possible maximum number of 4,096 (2¹²) VLANs. Note that user priority and VLAN ID are independent of each other. A frame with VID (VLAN Identifier) of null (0) is called a priority frame, meaning that only the priority level is significant and the default VID of the ingress port is given as the VID of the frame. Of the 4096 possible VIDs, a VID of 0 is used to identify priority frames and value 4095 (FFF) is reserved, so the maximum possible VLAN configurations are 4,094.

TPID 2 Bytes	User Priority 3 Bits	CFI 1 Bit	VLAN ID 12 bits
-----------------	-------------------------	--------------	--------------------

The ES-2024 handles up to 2048 VLANs (VIDs 1-2048). The switch accepts incoming frames with VIDs 1-2048. The switch drops incoming frames with a VID higher than 2048.

7.1.1 Forwarding Tagged and Untagged Frames

Each port on the switch is capable of passing tagged or untagged frames. To forward a frame from an 802.1Q VLAN-aware switch to an 802.1Q VLAN-unaware switch, the switch first decides where to forward the frame and then strips off the VLAN tag. To forward a frame from an 802.1Q VLAN-unaware switch to an 802.1Q VLAN-aware switch, the switch first decides where to forward the frame, and then inserts a VLAN tag reflecting the ingress port's default VID. The default PVID is VLAN 1 for all ports, but this can be changed.

7.1.2 Automatic VLAN Registration

GARP and GVRP are the protocols used to automatically register VLAN membership across switches.

GARP

GARP (Generic Attribute Registration Protocol) allows network switches to register and de-register attribute values with other GARP participants within a bridged LAN. GARP is a protocol that provides a generic mechanism for protocols that serve a more specific application, for example, GVRP.

GARP Timers

Switches join VLANs by making a declaration. A declaration is made by issuing a Join message using GARP. Declarations are withdrawn by issuing a Leave message. A Leave All message terminates all registrations. GARP timers set declaration timeout values.

GVRP

GVRP (GARP VLAN Registration Protocol) is a registration protocol that defines a way for switches to register necessary VLAN members on ports across the network. Enable this function to permit VLANs groups beyond the local switch.

Please refer to the following table for common GARP terminology.

Table 7-1 GARP Terminology

VLAN PARAMETER	TERM	DESCRIPTION
VLAN Type	Permanent VLAN	This is a static VLAN created manually.
	Dynamic VLAN	This is a VLAN configured by a GVRP registration/deregistration process.
VLAN Administrative Control	Registration Fixed	Fixed registration ports are permanent VLAN members.
	Registration Forbidden	Ports with registration forbidden are forbidden to join the specified VLAN.
	Normal Registration	Ports dynamically join a VLAN using GVRP.
VLAN Tag Control	Tagged	Ports belonging to the specified VLAN tag all outgoing frames transmitted.
	Untagged	Ports belonging to the specified don't tag all outgoing frames transmitted.
VLAN Port	Port VID	This is the VLAN ID assigned to untagged frames that this port received.
	Acceptable frame type	You may choose to accept both tagged and untagged incoming frames or just tagged incoming frames on a port.
	Ingress filtering	If set, the switch discards incoming frames for VLANs that do not have this port as a member

7.2 802.1Q VLAN

Follow the steps below to set the **802.1Q VLAN Type** on the switch.

Step 1. Select **802.1Q** as the **VLAN Type** in the **Switch Setup** screen (under **Basic Setting**) and click **Apply**.

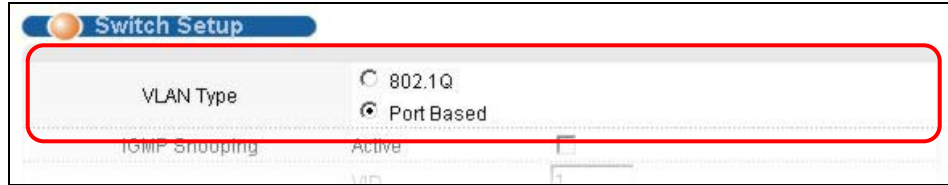

Figure 7-1 Selecting a VLAN Type

Step 2. Click **VLAN** under **Advanced Application** to display the **VLAN Status** screen as shown next.

The screenshot shows the 'VLAN Status' screen. It displays 'The Number Of VLAN = 1'. Below this is a table with the following data:

Index	VID	Port Number												Elapsed Time	Status	
		2	4	6	8	10	12	14	16	18	20	22	24			26
1	1	U	U	U	U	U	U	U	U	U	U	U	U	U	1:24:18	Static

At the bottom of the screen, there are controls for 'Poll Interval(s)' (set to 40), 'Set Interval', 'Stop', 'Change Pages', 'Previous Page', and 'Next Page'.

Figure 7-2 802.1Q VLAN Status

The following table describes the labels in this screen.

Table 7-2 802.1Q VLAN Status

LABEL	DESCRIPTION
The Number of VLAN	This is the number of VLANs configured on the switch.
Index	This is the VLAN index number.

Table 7-2 802.1Q VLAN Status

LABEL	DESCRIPTION
VID	VID is the PVID, the Port VLAN ID assigned to untagged frames or priority-tagged frames received on this port that you configure in the VLAN Port Setting screen.
Port Number	This column displays the ports that are participating in a VLAN. A tagged port is marked as T , an untagged port is marked as U and ports not participating in a VLAN in marked as “-”.
Elapsed Time	This field shows how long it has been since a normal VLAN was registered or a static VLAN was set up.
Status	This field shows how this VLAN was added to the switch; dynamically using GVRP or statically, that is, added as a permanent entry.
Poll Interval(s)	The text box displays how often (in seconds) this screen refreshes. You may change the refresh interval by typing a new number in the text box and then clicking Set Interval .
Stop	Click Stop to halt polling statistics.
Previous/Next Page	Click one of these buttons to show the previous/next screen if all status information cannot be seen in one screen.

7.2.1 802.1Q VLAN Port Settings

To configure the 802.1Q VLAN settings on a port, click the **VLAN Port Setting** link in the **VLAN Status** screen.

Figure 7-3 802.1Q VLAN Port Settings

The following table describes the labels in this screen.

Table 7-3 802.1Q VLAN Port Settings

LABEL	DESCRIPTION
GVRP	GVRP (GARP VLAN Registration Protocol) is a registration protocol that defines a way for switches to dynamically register necessary VLAN members on ports across the network. Select this check box to permit VLAN groups beyond the local switch.
Port	This field displays the port numbers.
Ingress Check	If this check box is selected for a port, the device discards incoming frames for VLANs that do not include this port in its member set.

Table 7-3 802.1Q VLAN Port Settings

LABEL	DESCRIPTION
PVID	Each port on the switch is capable of passing tagged or untagged frames. To forward a frame from an 802.1Q VLAN-unaware switch to an 802.1Q VLAN-aware switch, the switch first decides where to forward the frame, and then inserts a VLAN tag reflecting the default ingress port's VLAN ID, the PVID. The default PVID is VLAN 1 for all ports, but this can be changed to any number from 1 to 255.
GVRP	Select this check box to permit VLANs groups beyond the local switch on this port. GVRP (GARP VLAN Registration Protocol) is a registration protocol that defines a way for switches to register necessary VLAN members on ports across the network.
Acceptable Frame Type	Specify the type of frames allowed on a port. Choices are All , Tag Only and Untag Only . Select All to accept all frames with untagged or tagged frames on this port. This is the default setting. Select Tag Only to accept only tagged frames on this port. All untagged frames are dropped. Select Untag Only to accept only untagged frames on this port. All tagged frames are dropped.
Apply	Click Apply to save the changes.
Cancel	Click Cancel to start configuring the screen again.

7.2.2 802.1Q Static VLAN

You can dynamically have a port join a VLAN group using GVRP, permanently assign a port to be a member of a VLAN group or prohibit a port from joining a VLAN group in this screen. Click **Static VLAN** in the **VLAN Status** screen to display the screen as shown next.

Static VLAN
[VLAN Status](#)

ACTIVE

Name

VLAN Group ID

Port	Control			Tagging
1	<input checked="" type="radio"/> Normal	<input type="radio"/> Fixed	<input type="radio"/> Forbidden	<input checked="" type="checkbox"/> Tx Tagging
2	<input checked="" type="radio"/> Normal	<input type="radio"/> Fixed	<input type="radio"/> Forbidden	<input checked="" type="checkbox"/> Tx Tagging
3	<input checked="" type="radio"/> Normal	<input type="radio"/> Fixed	<input type="radio"/> Forbidden	<input checked="" type="checkbox"/> Tx Tagging
4	<input checked="" type="radio"/> Normal	<input type="radio"/> Fixed	<input type="radio"/> Forbidden	<input checked="" type="checkbox"/> Tx Tagging
5	<input checked="" type="radio"/> Normal	<input type="radio"/> Fixed	<input type="radio"/> Forbidden	<input checked="" type="checkbox"/> Tx Tagging
6	<input checked="" type="radio"/> Normal	<input type="radio"/> Fixed	<input type="radio"/> Forbidden	<input checked="" type="checkbox"/> Tx Tagging
7	<input checked="" type="radio"/> Normal	<input type="radio"/> Fixed	<input type="radio"/> Forbidden	<input checked="" type="checkbox"/> Tx Tagging
8	<input checked="" type="radio"/> Normal	<input type="radio"/> Fixed	<input type="radio"/> Forbidden	<input checked="" type="checkbox"/> Tx Tagging
9	<input checked="" type="radio"/> Normal	<input type="radio"/> Fixed	<input type="radio"/> Forbidden	<input checked="" type="checkbox"/> Tx Tagging
10	<input checked="" type="radio"/> Normal	<input type="radio"/> Fixed	<input type="radio"/> Forbidden	<input checked="" type="checkbox"/> Tx Tagging
11	<input checked="" type="radio"/> Normal	<input type="radio"/> Fixed	<input type="radio"/> Forbidden	<input checked="" type="checkbox"/> Tx Tagging
12	<input checked="" type="radio"/> Normal	<input type="radio"/> Fixed	<input type="radio"/> Forbidden	<input checked="" type="checkbox"/> Tx Tagging
13	<input checked="" type="radio"/> Normal	<input type="radio"/> Fixed	<input type="radio"/> Forbidden	<input checked="" type="checkbox"/> Tx Tagging
14	<input checked="" type="radio"/> Normal	<input type="radio"/> Fixed	<input type="radio"/> Forbidden	<input checked="" type="checkbox"/> Tx Tagging
15	<input checked="" type="radio"/> Normal	<input type="radio"/> Fixed	<input type="radio"/> Forbidden	<input checked="" type="checkbox"/> Tx Tagging
16	<input checked="" type="radio"/> Normal	<input type="radio"/> Fixed	<input type="radio"/> Forbidden	<input checked="" type="checkbox"/> Tx Tagging
17	<input checked="" type="radio"/> Normal	<input type="radio"/> Fixed	<input type="radio"/> Forbidden	<input checked="" type="checkbox"/> Tx Tagging
18	<input checked="" type="radio"/> Normal	<input type="radio"/> Fixed	<input type="radio"/> Forbidden	<input checked="" type="checkbox"/> Tx Tagging
19	<input checked="" type="radio"/> Normal	<input type="radio"/> Fixed	<input type="radio"/> Forbidden	<input checked="" type="checkbox"/> Tx Tagging
20	<input checked="" type="radio"/> Normal	<input type="radio"/> Fixed	<input type="radio"/> Forbidden	<input checked="" type="checkbox"/> Tx Tagging
21	<input checked="" type="radio"/> Normal	<input type="radio"/> Fixed	<input type="radio"/> Forbidden	<input checked="" type="checkbox"/> Tx Tagging
22	<input checked="" type="radio"/> Normal	<input type="radio"/> Fixed	<input type="radio"/> Forbidden	<input checked="" type="checkbox"/> Tx Tagging
23	<input checked="" type="radio"/> Normal	<input type="radio"/> Fixed	<input type="radio"/> Forbidden	<input checked="" type="checkbox"/> Tx Tagging
24	<input checked="" type="radio"/> Normal	<input type="radio"/> Fixed	<input type="radio"/> Forbidden	<input checked="" type="checkbox"/> Tx Tagging
25	<input checked="" type="radio"/> Normal	<input type="radio"/> Fixed	<input type="radio"/> Forbidden	<input checked="" type="checkbox"/> Tx Tagging
26	<input checked="" type="radio"/> Normal	<input type="radio"/> Fixed	<input type="radio"/> Forbidden	<input checked="" type="checkbox"/> Tx Tagging

VID	Active	Name	Delete
1	Yes	1	<input type="checkbox"/>

Figure 7-4 802.1Q Static VLAN

The following table describes the labels in this screen.

Table 7-4 802.1Q Static VLAN

LABEL	DESCRIPTION
ACTIVE	Select this check box to enable the VLAN.
Name	Enter a descriptive name for this VLAN group for identification purposes.
VLAN Group ID	Enter the VLAN ID for this static VLAN entry; the valid range is between 1 and 2048.
Port	The port number identifies the port you are configuring. Ports 25 and 26 are the gigabit ports.
Control	Select Normal for the port to dynamically join this VLAN group using GVRP. This is the default selection. Select Fixed for the port to be a permanent member of this VLAN group. Select Forbidden if you want to prohibit the port from joining this VLAN group.
Tagging	Select TX Tagging if you want the port to tag all outgoing frames transmitted with this VLAN Group ID.
Add	Click Add to save the new rule to the switch. It then displays in the summary table at the bottom of the screen.
Cancel	Click Cancel to reset the fields to your previous configuration.
Clear	Click Clear to clear the fields to the factory defaults.

7.2.3 Viewing and Editing VLAN Settings

To view a summary of the VLAN configuration, scroll down to the summary table at the bottom of the **Static VLAN** screen.

To change the settings of a rule, click a number in the **VID** field.

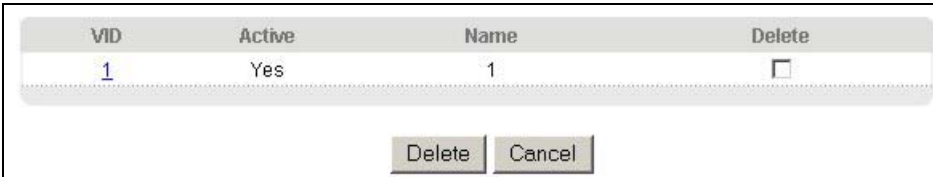

VID	Active	Name	Delete
1	Yes	1	<input type="checkbox"/>

Delete Cancel

Figure 7-5 Static VLAN: Summary Table

The following table describes the labels in this screen.

Table 7-5 Static VLAN: Summary Table

LABEL	DESCRIPTION
VID	This field displays the ID number of the VLAN group. Click the number to edit the VLAN settings.
Active	This field indicates whether the VLAN settings are enabled (Yes) or disabled (No).
Name	This field displays the descriptive name for this VLAN group.
Delete	Click Delete to remove the selected entry from the summary table.
Cancel	Click Cancel to clear the Delete check boxes.

VID1 Example Screen

Static VLAN
[VLAN Status](#)

ACTIVE

Name

VLAN Group ID

Port	Control			Tagging
1	<input type="radio"/> Normal	<input checked="" type="radio"/> Fixed	<input type="radio"/> Forbidden	<input type="checkbox"/> Tx Tagging
2	<input type="radio"/> Normal	<input checked="" type="radio"/> Fixed	<input type="radio"/> Forbidden	<input type="checkbox"/> Tx Tagging
3	<input type="radio"/> Normal	<input checked="" type="radio"/> Fixed	<input type="radio"/> Forbidden	<input type="checkbox"/> Tx Tagging
4	<input type="radio"/> Normal	<input checked="" type="radio"/> Fixed	<input type="radio"/> Forbidden	<input type="checkbox"/> Tx Tagging
5	<input type="radio"/> Normal	<input checked="" type="radio"/> Fixed	<input type="radio"/> Forbidden	<input type="checkbox"/> Tx Tagging
6	<input type="radio"/> Normal	<input checked="" type="radio"/> Fixed	<input type="radio"/> Forbidden	<input type="checkbox"/> Tx Tagging
7	<input type="radio"/> Normal	<input checked="" type="radio"/> Fixed	<input type="radio"/> Forbidden	<input type="checkbox"/> Tx Tagging
8	<input type="radio"/> Normal	<input checked="" type="radio"/> Fixed	<input type="radio"/> Forbidden	<input type="checkbox"/> Tx Tagging
9	<input type="radio"/> Normal	<input checked="" type="radio"/> Fixed	<input type="radio"/> Forbidden	<input type="checkbox"/> Tx Tagging
10	<input type="radio"/> Normal	<input checked="" type="radio"/> Fixed	<input type="radio"/> Forbidden	<input type="checkbox"/> Tx Tagging
11	<input type="radio"/> Normal	<input checked="" type="radio"/> Fixed	<input type="radio"/> Forbidden	<input type="checkbox"/> Tx Tagging
12	<input type="radio"/> Normal	<input checked="" type="radio"/> Fixed	<input type="radio"/> Forbidden	<input type="checkbox"/> Tx Tagging
13	<input type="radio"/> Normal	<input checked="" type="radio"/> Fixed	<input type="radio"/> Forbidden	<input type="checkbox"/> Tx Tagging
14	<input type="radio"/> Normal	<input checked="" type="radio"/> Fixed	<input type="radio"/> Forbidden	<input type="checkbox"/> Tx Tagging
15	<input type="radio"/> Normal	<input checked="" type="radio"/> Fixed	<input type="radio"/> Forbidden	<input type="checkbox"/> Tx Tagging
16	<input type="radio"/> Normal	<input checked="" type="radio"/> Fixed	<input type="radio"/> Forbidden	<input type="checkbox"/> Tx Tagging
17	<input type="radio"/> Normal	<input checked="" type="radio"/> Fixed	<input type="radio"/> Forbidden	<input type="checkbox"/> Tx Tagging
18	<input type="radio"/> Normal	<input checked="" type="radio"/> Fixed	<input type="radio"/> Forbidden	<input type="checkbox"/> Tx Tagging
19	<input type="radio"/> Normal	<input checked="" type="radio"/> Fixed	<input type="radio"/> Forbidden	<input type="checkbox"/> Tx Tagging
20	<input type="radio"/> Normal	<input checked="" type="radio"/> Fixed	<input type="radio"/> Forbidden	<input type="checkbox"/> Tx Tagging
21	<input type="radio"/> Normal	<input checked="" type="radio"/> Fixed	<input type="radio"/> Forbidden	<input type="checkbox"/> Tx Tagging
22	<input type="radio"/> Normal	<input checked="" type="radio"/> Fixed	<input type="radio"/> Forbidden	<input type="checkbox"/> Tx Tagging
23	<input type="radio"/> Normal	<input checked="" type="radio"/> Fixed	<input type="radio"/> Forbidden	<input type="checkbox"/> Tx Tagging
24	<input type="radio"/> Normal	<input checked="" type="radio"/> Fixed	<input type="radio"/> Forbidden	<input type="checkbox"/> Tx Tagging
25	<input type="radio"/> Normal	<input checked="" type="radio"/> Fixed	<input type="radio"/> Forbidden	<input type="checkbox"/> Tx Tagging
26	<input type="radio"/> Normal	<input checked="" type="radio"/> Fixed	<input type="radio"/> Forbidden	<input type="checkbox"/> Tx Tagging

VID	Active	Name	Delete
<u>1</u>	Yes	1	<input type="checkbox"/>

Figure 7-6 VID1 Example Screen

7.3 Introduction to Port-based VLANs

Port-based VLANs are VLANs where the packet forwarding decision is based on the destination MAC address and its associated port.

Port-based VLANs require allowed outgoing ports to be defined for each port. Therefore, if you wish to allow two subscriber ports to talk to each other, for example, between conference rooms in a hotel, you must define the egress (an egress port is an outgoing port, that is, a port through which a data packet leaves) for both ports.

Port-based VLANs are specific only to the switch on which they were created.

The port-based VLAN setup screen is shown next. The **CPU** management port forms a VLAN with all Ethernet ports.

7.3.1 Configuring a Port-based VLAN

Select **Port Based** as the **VLAN Type** in the **Switch Setup** screen under **Basic Setting** and then click **VLAN** under **Advanced Application** to display the next screen.

Port Based VLAN Setup

Setting Wizard All connected ▾ Apply

Incoming

	1	2	3	4	5	6	7	8	9	10	11	12	13	14	15	16	17	18	19	20	21
1	<input checked="" type="checkbox"/>	<input checked="" type="checkbox"/>	<input checked="" type="checkbox"/>	<input checked="" type="checkbox"/>	<input checked="" type="checkbox"/>	<input checked="" type="checkbox"/>	<input checked="" type="checkbox"/>	<input checked="" type="checkbox"/>	<input checked="" type="checkbox"/>	<input checked="" type="checkbox"/>	<input checked="" type="checkbox"/>	<input checked="" type="checkbox"/>	<input checked="" type="checkbox"/>	<input checked="" type="checkbox"/>	<input checked="" type="checkbox"/>	<input checked="" type="checkbox"/>	<input checked="" type="checkbox"/>	<input checked="" type="checkbox"/>	<input checked="" type="checkbox"/>	<input checked="" type="checkbox"/>	<input checked="" type="checkbox"/>
2	<input checked="" type="checkbox"/>	<input checked="" type="checkbox"/>	<input checked="" type="checkbox"/>	<input checked="" type="checkbox"/>	<input checked="" type="checkbox"/>	<input checked="" type="checkbox"/>	<input checked="" type="checkbox"/>	<input checked="" type="checkbox"/>	<input checked="" type="checkbox"/>	<input checked="" type="checkbox"/>	<input checked="" type="checkbox"/>	<input checked="" type="checkbox"/>	<input checked="" type="checkbox"/>	<input checked="" type="checkbox"/>	<input checked="" type="checkbox"/>	<input checked="" type="checkbox"/>	<input checked="" type="checkbox"/>	<input checked="" type="checkbox"/>	<input checked="" type="checkbox"/>	<input checked="" type="checkbox"/>	<input checked="" type="checkbox"/>
3	<input checked="" type="checkbox"/>	<input checked="" type="checkbox"/>	<input checked="" type="checkbox"/>	<input checked="" type="checkbox"/>	<input checked="" type="checkbox"/>	<input checked="" type="checkbox"/>	<input checked="" type="checkbox"/>	<input checked="" type="checkbox"/>	<input checked="" type="checkbox"/>	<input checked="" type="checkbox"/>	<input checked="" type="checkbox"/>	<input checked="" type="checkbox"/>	<input checked="" type="checkbox"/>	<input checked="" type="checkbox"/>	<input checked="" type="checkbox"/>	<input checked="" type="checkbox"/>	<input checked="" type="checkbox"/>	<input checked="" type="checkbox"/>	<input checked="" type="checkbox"/>	<input checked="" type="checkbox"/>	<input checked="" type="checkbox"/>
4	<input checked="" type="checkbox"/>	<input checked="" type="checkbox"/>	<input checked="" type="checkbox"/>	<input checked="" type="checkbox"/>	<input checked="" type="checkbox"/>	<input checked="" type="checkbox"/>	<input checked="" type="checkbox"/>	<input checked="" type="checkbox"/>	<input checked="" type="checkbox"/>	<input checked="" type="checkbox"/>	<input checked="" type="checkbox"/>	<input checked="" type="checkbox"/>	<input checked="" type="checkbox"/>	<input checked="" type="checkbox"/>	<input checked="" type="checkbox"/>	<input checked="" type="checkbox"/>	<input checked="" type="checkbox"/>	<input checked="" type="checkbox"/>	<input checked="" type="checkbox"/>	<input checked="" type="checkbox"/>	<input checked="" type="checkbox"/>
5	<input checked="" type="checkbox"/>	<input checked="" type="checkbox"/>	<input checked="" type="checkbox"/>	<input checked="" type="checkbox"/>	<input checked="" type="checkbox"/>	<input checked="" type="checkbox"/>	<input checked="" type="checkbox"/>	<input checked="" type="checkbox"/>	<input checked="" type="checkbox"/>	<input checked="" type="checkbox"/>	<input checked="" type="checkbox"/>	<input checked="" type="checkbox"/>	<input checked="" type="checkbox"/>	<input checked="" type="checkbox"/>	<input checked="" type="checkbox"/>	<input checked="" type="checkbox"/>	<input checked="" type="checkbox"/>	<input checked="" type="checkbox"/>	<input checked="" type="checkbox"/>	<input checked="" type="checkbox"/>	<input checked="" type="checkbox"/>
6	<input checked="" type="checkbox"/>	<input checked="" type="checkbox"/>	<input checked="" type="checkbox"/>	<input checked="" type="checkbox"/>	<input checked="" type="checkbox"/>	<input checked="" type="checkbox"/>	<input checked="" type="checkbox"/>	<input checked="" type="checkbox"/>	<input checked="" type="checkbox"/>	<input checked="" type="checkbox"/>	<input checked="" type="checkbox"/>	<input checked="" type="checkbox"/>	<input checked="" type="checkbox"/>	<input checked="" type="checkbox"/>	<input checked="" type="checkbox"/>	<input checked="" type="checkbox"/>	<input checked="" type="checkbox"/>	<input checked="" type="checkbox"/>	<input checked="" type="checkbox"/>	<input checked="" type="checkbox"/>	<input checked="" type="checkbox"/>
7	<input checked="" type="checkbox"/>	<input checked="" type="checkbox"/>	<input checked="" type="checkbox"/>	<input checked="" type="checkbox"/>	<input checked="" type="checkbox"/>	<input checked="" type="checkbox"/>	<input checked="" type="checkbox"/>	<input checked="" type="checkbox"/>	<input checked="" type="checkbox"/>	<input checked="" type="checkbox"/>	<input checked="" type="checkbox"/>	<input checked="" type="checkbox"/>	<input checked="" type="checkbox"/>	<input checked="" type="checkbox"/>	<input checked="" type="checkbox"/>	<input checked="" type="checkbox"/>	<input checked="" type="checkbox"/>	<input checked="" type="checkbox"/>	<input checked="" type="checkbox"/>	<input checked="" type="checkbox"/>	<input checked="" type="checkbox"/>
8	<input checked="" type="checkbox"/>	<input checked="" type="checkbox"/>	<input checked="" type="checkbox"/>	<input checked="" type="checkbox"/>	<input checked="" type="checkbox"/>	<input checked="" type="checkbox"/>	<input checked="" type="checkbox"/>	<input checked="" type="checkbox"/>	<input checked="" type="checkbox"/>	<input checked="" type="checkbox"/>	<input checked="" type="checkbox"/>	<input checked="" type="checkbox"/>	<input checked="" type="checkbox"/>	<input checked="" type="checkbox"/>	<input checked="" type="checkbox"/>	<input checked="" type="checkbox"/>	<input checked="" type="checkbox"/>	<input checked="" type="checkbox"/>	<input checked="" type="checkbox"/>	<input checked="" type="checkbox"/>	<input checked="" type="checkbox"/>
9	<input checked="" type="checkbox"/>	<input checked="" type="checkbox"/>	<input checked="" type="checkbox"/>	<input checked="" type="checkbox"/>	<input checked="" type="checkbox"/>	<input checked="" type="checkbox"/>	<input checked="" type="checkbox"/>	<input checked="" type="checkbox"/>	<input checked="" type="checkbox"/>	<input checked="" type="checkbox"/>	<input checked="" type="checkbox"/>	<input checked="" type="checkbox"/>	<input checked="" type="checkbox"/>	<input checked="" type="checkbox"/>	<input checked="" type="checkbox"/>	<input checked="" type="checkbox"/>	<input checked="" type="checkbox"/>	<input checked="" type="checkbox"/>	<input checked="" type="checkbox"/>	<input checked="" type="checkbox"/>	<input checked="" type="checkbox"/>
10	<input checked="" type="checkbox"/>	<input checked="" type="checkbox"/>	<input checked="" type="checkbox"/>	<input checked="" type="checkbox"/>	<input checked="" type="checkbox"/>	<input checked="" type="checkbox"/>	<input checked="" type="checkbox"/>	<input checked="" type="checkbox"/>	<input checked="" type="checkbox"/>	<input checked="" type="checkbox"/>	<input checked="" type="checkbox"/>	<input checked="" type="checkbox"/>	<input checked="" type="checkbox"/>	<input checked="" type="checkbox"/>	<input checked="" type="checkbox"/>	<input checked="" type="checkbox"/>	<input checked="" type="checkbox"/>	<input checked="" type="checkbox"/>	<input checked="" type="checkbox"/>	<input checked="" type="checkbox"/>	<input checked="" type="checkbox"/>
11	<input checked="" type="checkbox"/>	<input checked="" type="checkbox"/>	<input checked="" type="checkbox"/>	<input checked="" type="checkbox"/>	<input checked="" type="checkbox"/>	<input checked="" type="checkbox"/>	<input checked="" type="checkbox"/>	<input checked="" type="checkbox"/>	<input checked="" type="checkbox"/>	<input checked="" type="checkbox"/>	<input checked="" type="checkbox"/>	<input checked="" type="checkbox"/>	<input checked="" type="checkbox"/>	<input checked="" type="checkbox"/>	<input checked="" type="checkbox"/>	<input checked="" type="checkbox"/>	<input checked="" type="checkbox"/>	<input checked="" type="checkbox"/>	<input checked="" type="checkbox"/>	<input checked="" type="checkbox"/>	<input checked="" type="checkbox"/>
12	<input checked="" type="checkbox"/>	<input checked="" type="checkbox"/>	<input checked="" type="checkbox"/>	<input checked="" type="checkbox"/>	<input checked="" type="checkbox"/>	<input checked="" type="checkbox"/>	<input checked="" type="checkbox"/>	<input checked="" type="checkbox"/>	<input checked="" type="checkbox"/>	<input checked="" type="checkbox"/>	<input checked="" type="checkbox"/>	<input checked="" type="checkbox"/>	<input checked="" type="checkbox"/>	<input checked="" type="checkbox"/>	<input checked="" type="checkbox"/>	<input checked="" type="checkbox"/>	<input checked="" type="checkbox"/>	<input checked="" type="checkbox"/>	<input checked="" type="checkbox"/>	<input checked="" type="checkbox"/>	<input checked="" type="checkbox"/>
13	<input checked="" type="checkbox"/>	<input checked="" type="checkbox"/>	<input checked="" type="checkbox"/>	<input checked="" type="checkbox"/>	<input checked="" type="checkbox"/>	<input checked="" type="checkbox"/>	<input checked="" type="checkbox"/>	<input checked="" type="checkbox"/>	<input checked="" type="checkbox"/>	<input checked="" type="checkbox"/>	<input checked="" type="checkbox"/>	<input checked="" type="checkbox"/>	<input checked="" type="checkbox"/>	<input checked="" type="checkbox"/>	<input checked="" type="checkbox"/>	<input checked="" type="checkbox"/>	<input checked="" type="checkbox"/>	<input checked="" type="checkbox"/>	<input checked="" type="checkbox"/>	<input checked="" type="checkbox"/>	<input checked="" type="checkbox"/>
14	<input checked="" type="checkbox"/>	<input checked="" type="checkbox"/>	<input checked="" type="checkbox"/>	<input checked="" type="checkbox"/>	<input checked="" type="checkbox"/>	<input checked="" type="checkbox"/>	<input checked="" type="checkbox"/>	<input checked="" type="checkbox"/>	<input checked="" type="checkbox"/>	<input checked="" type="checkbox"/>	<input checked="" type="checkbox"/>	<input checked="" type="checkbox"/>	<input checked="" type="checkbox"/>	<input checked="" type="checkbox"/>	<input checked="" type="checkbox"/>	<input checked="" type="checkbox"/>	<input checked="" type="checkbox"/>	<input checked="" type="checkbox"/>	<input checked="" type="checkbox"/>	<input checked="" type="checkbox"/>	<input checked="" type="checkbox"/>
15	<input checked="" type="checkbox"/>	<input checked="" type="checkbox"/>	<input checked="" type="checkbox"/>	<input checked="" type="checkbox"/>	<input checked="" type="checkbox"/>	<input checked="" type="checkbox"/>	<input checked="" type="checkbox"/>	<input checked="" type="checkbox"/>	<input checked="" type="checkbox"/>	<input checked="" type="checkbox"/>	<input checked="" type="checkbox"/>	<input checked="" type="checkbox"/>	<input checked="" type="checkbox"/>	<input checked="" type="checkbox"/>	<input checked="" type="checkbox"/>	<input checked="" type="checkbox"/>	<input checked="" type="checkbox"/>	<input checked="" type="checkbox"/>	<input checked="" type="checkbox"/>	<input checked="" type="checkbox"/>	<input checked="" type="checkbox"/>
16	<input checked="" type="checkbox"/>	<input checked="" type="checkbox"/>	<input checked="" type="checkbox"/>	<input checked="" type="checkbox"/>	<input checked="" type="checkbox"/>	<input checked="" type="checkbox"/>	<input checked="" type="checkbox"/>	<input checked="" type="checkbox"/>	<input checked="" type="checkbox"/>	<input checked="" type="checkbox"/>	<input checked="" type="checkbox"/>	<input checked="" type="checkbox"/>	<input checked="" type="checkbox"/>	<input checked="" type="checkbox"/>	<input checked="" type="checkbox"/>	<input checked="" type="checkbox"/>	<input checked="" type="checkbox"/>	<input checked="" type="checkbox"/>	<input checked="" type="checkbox"/>	<input checked="" type="checkbox"/>	<input checked="" type="checkbox"/>
17	<input checked="" type="checkbox"/>	<input checked="" type="checkbox"/>	<input checked="" type="checkbox"/>	<input checked="" type="checkbox"/>	<input checked="" type="checkbox"/>	<input checked="" type="checkbox"/>	<input checked="" type="checkbox"/>	<input checked="" type="checkbox"/>	<input checked="" type="checkbox"/>	<input checked="" type="checkbox"/>	<input checked="" type="checkbox"/>	<input checked="" type="checkbox"/>	<input checked="" type="checkbox"/>	<input checked="" type="checkbox"/>	<input checked="" type="checkbox"/>	<input checked="" type="checkbox"/>	<input checked="" type="checkbox"/>	<input checked="" type="checkbox"/>	<input checked="" type="checkbox"/>	<input checked="" type="checkbox"/>	<input checked="" type="checkbox"/>
18	<input checked="" type="checkbox"/>	<input checked="" type="checkbox"/>	<input checked="" type="checkbox"/>	<input checked="" type="checkbox"/>	<input checked="" type="checkbox"/>	<input checked="" type="checkbox"/>	<input checked="" type="checkbox"/>	<input checked="" type="checkbox"/>	<input checked="" type="checkbox"/>	<input checked="" type="checkbox"/>	<input checked="" type="checkbox"/>	<input checked="" type="checkbox"/>	<input checked="" type="checkbox"/>	<input checked="" type="checkbox"/>	<input checked="" type="checkbox"/>	<input checked="" type="checkbox"/>	<input checked="" type="checkbox"/>	<input checked="" type="checkbox"/>	<input checked="" type="checkbox"/>	<input checked="" type="checkbox"/>	<input checked="" type="checkbox"/>
19	<input checked="" type="checkbox"/>	<input checked="" type="checkbox"/>	<input checked="" type="checkbox"/>	<input checked="" type="checkbox"/>	<input checked="" type="checkbox"/>	<input checked="" type="checkbox"/>	<input checked="" type="checkbox"/>	<input checked="" type="checkbox"/>	<input checked="" type="checkbox"/>	<input checked="" type="checkbox"/>	<input checked="" type="checkbox"/>	<input checked="" type="checkbox"/>	<input checked="" type="checkbox"/>	<input checked="" type="checkbox"/>	<input checked="" type="checkbox"/>	<input checked="" type="checkbox"/>	<input checked="" type="checkbox"/>	<input checked="" type="checkbox"/>	<input checked="" type="checkbox"/>	<input checked="" type="checkbox"/>	<input checked="" type="checkbox"/>
20	<input checked="" type="checkbox"/>	<input checked="" type="checkbox"/>	<input checked="" type="checkbox"/>	<input checked="" type="checkbox"/>	<input checked="" type="checkbox"/>	<input checked="" type="checkbox"/>	<input checked="" type="checkbox"/>	<input checked="" type="checkbox"/>	<input checked="" type="checkbox"/>	<input checked="" type="checkbox"/>	<input checked="" type="checkbox"/>	<input checked="" type="checkbox"/>	<input checked="" type="checkbox"/>	<input checked="" type="checkbox"/>	<input checked="" type="checkbox"/>	<input checked="" type="checkbox"/>	<input checked="" type="checkbox"/>	<input checked="" type="checkbox"/>	<input checked="" type="checkbox"/>	<input checked="" type="checkbox"/>	<input checked="" type="checkbox"/>
21	<input checked="" type="checkbox"/>	<input checked="" type="checkbox"/>	<input checked="" type="checkbox"/>	<input checked="" type="checkbox"/>	<input checked="" type="checkbox"/>	<input checked="" type="checkbox"/>	<input checked="" type="checkbox"/>	<input checked="" type="checkbox"/>	<input checked="" type="checkbox"/>	<input checked="" type="checkbox"/>	<input checked="" type="checkbox"/>	<input checked="" type="checkbox"/>	<input checked="" type="checkbox"/>	<input checked="" type="checkbox"/>	<input checked="" type="checkbox"/>	<input checked="" type="checkbox"/>	<input checked="" type="checkbox"/>	<input checked="" type="checkbox"/>	<input checked="" type="checkbox"/>	<input checked="" type="checkbox"/>	<input checked="" type="checkbox"/>

Outgoing

Figure 7-7 Port Based VLAN Setup (All Connected)

Port Based VLAN Setup

Setting Wizard | Port isolation | Apply

Incoming

	1	2	3	4	5	6	7	8	9	10	11	12	13	14	15	16	17	18	19	20	21	22	23	24	25	26	
1	<input checked="" type="checkbox"/>	<input type="checkbox"/>	<input type="checkbox"/>	<input type="checkbox"/>	<input type="checkbox"/>	<input type="checkbox"/>	<input type="checkbox"/>	<input type="checkbox"/>	<input type="checkbox"/>	<input type="checkbox"/>	<input type="checkbox"/>	<input type="checkbox"/>	<input type="checkbox"/>	<input type="checkbox"/>	<input type="checkbox"/>	<input type="checkbox"/>	<input type="checkbox"/>	<input type="checkbox"/>	<input type="checkbox"/>	<input type="checkbox"/>	<input type="checkbox"/>	<input type="checkbox"/>	<input type="checkbox"/>	<input type="checkbox"/>	<input type="checkbox"/>	<input type="checkbox"/>	1
2	<input type="checkbox"/>	<input checked="" type="checkbox"/>	<input type="checkbox"/>	<input type="checkbox"/>	<input type="checkbox"/>	<input type="checkbox"/>	<input type="checkbox"/>	<input type="checkbox"/>	<input type="checkbox"/>	<input type="checkbox"/>	<input type="checkbox"/>	<input type="checkbox"/>	<input type="checkbox"/>	<input type="checkbox"/>	<input type="checkbox"/>	<input type="checkbox"/>	<input type="checkbox"/>	<input type="checkbox"/>	<input type="checkbox"/>	<input type="checkbox"/>	<input type="checkbox"/>	<input type="checkbox"/>	<input type="checkbox"/>	<input type="checkbox"/>	<input type="checkbox"/>	<input type="checkbox"/>	2
3	<input type="checkbox"/>	<input type="checkbox"/>	<input checked="" type="checkbox"/>	<input type="checkbox"/>	<input type="checkbox"/>	<input type="checkbox"/>	<input type="checkbox"/>	<input type="checkbox"/>	<input type="checkbox"/>	<input type="checkbox"/>	<input type="checkbox"/>	<input type="checkbox"/>	<input type="checkbox"/>	<input type="checkbox"/>	<input type="checkbox"/>	<input type="checkbox"/>	<input type="checkbox"/>	<input type="checkbox"/>	<input type="checkbox"/>	<input type="checkbox"/>	<input type="checkbox"/>	<input type="checkbox"/>	<input type="checkbox"/>	<input type="checkbox"/>	<input type="checkbox"/>	<input type="checkbox"/>	3
4	<input type="checkbox"/>	<input type="checkbox"/>	<input type="checkbox"/>	<input checked="" type="checkbox"/>	<input type="checkbox"/>	<input type="checkbox"/>	<input type="checkbox"/>	<input type="checkbox"/>	<input type="checkbox"/>	<input type="checkbox"/>	<input type="checkbox"/>	<input type="checkbox"/>	<input type="checkbox"/>	<input type="checkbox"/>	<input type="checkbox"/>	<input type="checkbox"/>	<input type="checkbox"/>	<input type="checkbox"/>	<input type="checkbox"/>	<input type="checkbox"/>	<input type="checkbox"/>	<input type="checkbox"/>	<input type="checkbox"/>	<input type="checkbox"/>	<input type="checkbox"/>	<input type="checkbox"/>	4
5	<input type="checkbox"/>	<input type="checkbox"/>	<input type="checkbox"/>	<input type="checkbox"/>	<input checked="" type="checkbox"/>	<input type="checkbox"/>	<input type="checkbox"/>	<input type="checkbox"/>	<input type="checkbox"/>	<input type="checkbox"/>	<input type="checkbox"/>	<input type="checkbox"/>	<input type="checkbox"/>	<input type="checkbox"/>	<input type="checkbox"/>	<input type="checkbox"/>	<input type="checkbox"/>	<input type="checkbox"/>	<input type="checkbox"/>	<input type="checkbox"/>	<input type="checkbox"/>	<input type="checkbox"/>	<input type="checkbox"/>	<input type="checkbox"/>	<input type="checkbox"/>	<input type="checkbox"/>	5
6	<input type="checkbox"/>	<input type="checkbox"/>	<input type="checkbox"/>	<input type="checkbox"/>	<input type="checkbox"/>	<input checked="" type="checkbox"/>	<input type="checkbox"/>	<input type="checkbox"/>	<input type="checkbox"/>	<input type="checkbox"/>	<input type="checkbox"/>	<input type="checkbox"/>	<input type="checkbox"/>	<input type="checkbox"/>	<input type="checkbox"/>	<input type="checkbox"/>	<input type="checkbox"/>	<input type="checkbox"/>	<input type="checkbox"/>	<input type="checkbox"/>	<input type="checkbox"/>	<input type="checkbox"/>	<input type="checkbox"/>	<input type="checkbox"/>	<input type="checkbox"/>	<input type="checkbox"/>	6
7	<input type="checkbox"/>	<input type="checkbox"/>	<input type="checkbox"/>	<input type="checkbox"/>	<input type="checkbox"/>	<input type="checkbox"/>	<input checked="" type="checkbox"/>	<input type="checkbox"/>	<input type="checkbox"/>	<input type="checkbox"/>	<input type="checkbox"/>	<input type="checkbox"/>	<input type="checkbox"/>	<input type="checkbox"/>	<input type="checkbox"/>	<input type="checkbox"/>	<input type="checkbox"/>	<input type="checkbox"/>	<input type="checkbox"/>	<input type="checkbox"/>	<input type="checkbox"/>	<input type="checkbox"/>	<input type="checkbox"/>	<input type="checkbox"/>	<input type="checkbox"/>	<input type="checkbox"/>	7
8	<input type="checkbox"/>	<input type="checkbox"/>	<input type="checkbox"/>	<input type="checkbox"/>	<input type="checkbox"/>	<input type="checkbox"/>	<input type="checkbox"/>	<input checked="" type="checkbox"/>	<input type="checkbox"/>	<input type="checkbox"/>	<input type="checkbox"/>	<input type="checkbox"/>	<input type="checkbox"/>	<input type="checkbox"/>	<input type="checkbox"/>	<input type="checkbox"/>	<input type="checkbox"/>	<input type="checkbox"/>	<input type="checkbox"/>	<input type="checkbox"/>	<input type="checkbox"/>	<input type="checkbox"/>	<input type="checkbox"/>	<input type="checkbox"/>	<input type="checkbox"/>	<input type="checkbox"/>	8
9	<input type="checkbox"/>	<input type="checkbox"/>	<input type="checkbox"/>	<input type="checkbox"/>	<input type="checkbox"/>	<input type="checkbox"/>	<input type="checkbox"/>	<input type="checkbox"/>	<input checked="" type="checkbox"/>	<input type="checkbox"/>	<input type="checkbox"/>	<input type="checkbox"/>	<input type="checkbox"/>	<input type="checkbox"/>	<input type="checkbox"/>	<input type="checkbox"/>	<input type="checkbox"/>	<input type="checkbox"/>	<input type="checkbox"/>	<input type="checkbox"/>	<input type="checkbox"/>	<input type="checkbox"/>	<input type="checkbox"/>	<input type="checkbox"/>	<input type="checkbox"/>	<input type="checkbox"/>	9
10	<input type="checkbox"/>	<input type="checkbox"/>	<input type="checkbox"/>	<input type="checkbox"/>	<input type="checkbox"/>	<input type="checkbox"/>	<input type="checkbox"/>	<input type="checkbox"/>	<input type="checkbox"/>	<input checked="" type="checkbox"/>	<input type="checkbox"/>	<input type="checkbox"/>	<input type="checkbox"/>	<input type="checkbox"/>	<input type="checkbox"/>	<input type="checkbox"/>	<input type="checkbox"/>	<input type="checkbox"/>	<input type="checkbox"/>	<input type="checkbox"/>	<input type="checkbox"/>	<input type="checkbox"/>	<input type="checkbox"/>	<input type="checkbox"/>	<input type="checkbox"/>	<input type="checkbox"/>	10
11	<input type="checkbox"/>	<input type="checkbox"/>	<input type="checkbox"/>	<input type="checkbox"/>	<input type="checkbox"/>	<input type="checkbox"/>	<input type="checkbox"/>	<input type="checkbox"/>	<input type="checkbox"/>	<input type="checkbox"/>	<input checked="" type="checkbox"/>	<input type="checkbox"/>	<input type="checkbox"/>	<input type="checkbox"/>	<input type="checkbox"/>	<input type="checkbox"/>	<input type="checkbox"/>	<input type="checkbox"/>	<input type="checkbox"/>	<input type="checkbox"/>	<input type="checkbox"/>	<input type="checkbox"/>	<input type="checkbox"/>	<input type="checkbox"/>	<input type="checkbox"/>	<input type="checkbox"/>	11
12	<input type="checkbox"/>	<input type="checkbox"/>	<input type="checkbox"/>	<input type="checkbox"/>	<input type="checkbox"/>	<input type="checkbox"/>	<input type="checkbox"/>	<input type="checkbox"/>	<input type="checkbox"/>	<input type="checkbox"/>	<input type="checkbox"/>	<input checked="" type="checkbox"/>	<input type="checkbox"/>	<input type="checkbox"/>	<input type="checkbox"/>	<input type="checkbox"/>	<input type="checkbox"/>	<input type="checkbox"/>	<input type="checkbox"/>	<input type="checkbox"/>	<input type="checkbox"/>	<input type="checkbox"/>	<input type="checkbox"/>	<input type="checkbox"/>	<input type="checkbox"/>	<input type="checkbox"/>	12
13	<input type="checkbox"/>	<input type="checkbox"/>	<input type="checkbox"/>	<input type="checkbox"/>	<input type="checkbox"/>	<input type="checkbox"/>	<input type="checkbox"/>	<input type="checkbox"/>	<input type="checkbox"/>	<input type="checkbox"/>	<input type="checkbox"/>	<input type="checkbox"/>	<input checked="" type="checkbox"/>	<input type="checkbox"/>	<input type="checkbox"/>	<input type="checkbox"/>	<input type="checkbox"/>	<input type="checkbox"/>	<input type="checkbox"/>	<input type="checkbox"/>	<input type="checkbox"/>	<input type="checkbox"/>	<input type="checkbox"/>	<input type="checkbox"/>	<input type="checkbox"/>	<input type="checkbox"/>	13
14	<input type="checkbox"/>	<input type="checkbox"/>	<input type="checkbox"/>	<input type="checkbox"/>	<input type="checkbox"/>	<input type="checkbox"/>	<input type="checkbox"/>	<input type="checkbox"/>	<input type="checkbox"/>	<input type="checkbox"/>	<input type="checkbox"/>	<input type="checkbox"/>	<input type="checkbox"/>	<input checked="" type="checkbox"/>	<input type="checkbox"/>	<input type="checkbox"/>	<input type="checkbox"/>	<input type="checkbox"/>	<input type="checkbox"/>	<input type="checkbox"/>	<input type="checkbox"/>	<input type="checkbox"/>	<input type="checkbox"/>	<input type="checkbox"/>	<input type="checkbox"/>	<input type="checkbox"/>	14
15	<input type="checkbox"/>	<input type="checkbox"/>	<input type="checkbox"/>	<input type="checkbox"/>	<input type="checkbox"/>	<input type="checkbox"/>	<input type="checkbox"/>	<input type="checkbox"/>	<input type="checkbox"/>	<input type="checkbox"/>	<input type="checkbox"/>	<input type="checkbox"/>	<input type="checkbox"/>	<input type="checkbox"/>	<input checked="" type="checkbox"/>	<input type="checkbox"/>	<input type="checkbox"/>	<input type="checkbox"/>	<input type="checkbox"/>	<input type="checkbox"/>	<input type="checkbox"/>	<input type="checkbox"/>	<input type="checkbox"/>	<input type="checkbox"/>	<input type="checkbox"/>	<input type="checkbox"/>	15
16	<input type="checkbox"/>	<input type="checkbox"/>	<input type="checkbox"/>	<input type="checkbox"/>	<input type="checkbox"/>	<input type="checkbox"/>	<input type="checkbox"/>	<input type="checkbox"/>	<input type="checkbox"/>	<input type="checkbox"/>	<input type="checkbox"/>	<input type="checkbox"/>	<input type="checkbox"/>	<input type="checkbox"/>	<input type="checkbox"/>	<input checked="" type="checkbox"/>	<input type="checkbox"/>	<input type="checkbox"/>	<input type="checkbox"/>	<input type="checkbox"/>	<input type="checkbox"/>	<input type="checkbox"/>	<input type="checkbox"/>	<input type="checkbox"/>	<input type="checkbox"/>	<input type="checkbox"/>	16
17	<input type="checkbox"/>	<input type="checkbox"/>	<input type="checkbox"/>	<input type="checkbox"/>	<input type="checkbox"/>	<input type="checkbox"/>	<input type="checkbox"/>	<input type="checkbox"/>	<input type="checkbox"/>	<input type="checkbox"/>	<input type="checkbox"/>	<input type="checkbox"/>	<input type="checkbox"/>	<input type="checkbox"/>	<input type="checkbox"/>	<input type="checkbox"/>	<input checked="" type="checkbox"/>	<input type="checkbox"/>	<input type="checkbox"/>	<input type="checkbox"/>	<input type="checkbox"/>	<input type="checkbox"/>	<input type="checkbox"/>	<input type="checkbox"/>	<input type="checkbox"/>	<input type="checkbox"/>	17
18	<input type="checkbox"/>	<input type="checkbox"/>	<input type="checkbox"/>	<input type="checkbox"/>	<input type="checkbox"/>	<input type="checkbox"/>	<input type="checkbox"/>	<input type="checkbox"/>	<input type="checkbox"/>	<input type="checkbox"/>	<input type="checkbox"/>	<input type="checkbox"/>	<input type="checkbox"/>	<input type="checkbox"/>	<input type="checkbox"/>	<input type="checkbox"/>	<input type="checkbox"/>	<input checked="" type="checkbox"/>	<input type="checkbox"/>	<input type="checkbox"/>	<input type="checkbox"/>	<input type="checkbox"/>	<input type="checkbox"/>	<input type="checkbox"/>	<input type="checkbox"/>	<input type="checkbox"/>	18
19	<input type="checkbox"/>	<input type="checkbox"/>	<input type="checkbox"/>	<input type="checkbox"/>	<input type="checkbox"/>	<input type="checkbox"/>	<input type="checkbox"/>	<input type="checkbox"/>	<input type="checkbox"/>	<input type="checkbox"/>	<input type="checkbox"/>	<input type="checkbox"/>	<input type="checkbox"/>	<input type="checkbox"/>	<input type="checkbox"/>	<input type="checkbox"/>	<input type="checkbox"/>	<input type="checkbox"/>	<input checked="" type="checkbox"/>	<input type="checkbox"/>	<input type="checkbox"/>	<input type="checkbox"/>	<input type="checkbox"/>	<input type="checkbox"/>	<input type="checkbox"/>	<input type="checkbox"/>	19
20	<input type="checkbox"/>	<input type="checkbox"/>	<input type="checkbox"/>	<input type="checkbox"/>	<input type="checkbox"/>	<input type="checkbox"/>	<input type="checkbox"/>	<input type="checkbox"/>	<input type="checkbox"/>	<input type="checkbox"/>	<input type="checkbox"/>	<input type="checkbox"/>	<input type="checkbox"/>	<input type="checkbox"/>	<input type="checkbox"/>	<input type="checkbox"/>	<input type="checkbox"/>	<input type="checkbox"/>	<input type="checkbox"/>	<input checked="" type="checkbox"/>	<input type="checkbox"/>	<input type="checkbox"/>	<input type="checkbox"/>	<input type="checkbox"/>	<input type="checkbox"/>	<input type="checkbox"/>	20
21	<input type="checkbox"/>	<input type="checkbox"/>	<input type="checkbox"/>	<input type="checkbox"/>	<input type="checkbox"/>	<input type="checkbox"/>	<input type="checkbox"/>	<input type="checkbox"/>	<input type="checkbox"/>	<input type="checkbox"/>	<input type="checkbox"/>	<input type="checkbox"/>	<input type="checkbox"/>	<input type="checkbox"/>	<input type="checkbox"/>	<input type="checkbox"/>	<input type="checkbox"/>	<input type="checkbox"/>	<input type="checkbox"/>	<input type="checkbox"/>	<input checked="" type="checkbox"/>	<input type="checkbox"/>	<input type="checkbox"/>	<input type="checkbox"/>	<input type="checkbox"/>	<input type="checkbox"/>	21
22	<input type="checkbox"/>	<input type="checkbox"/>	<input type="checkbox"/>	<input type="checkbox"/>	<input type="checkbox"/>	<input type="checkbox"/>	<input type="checkbox"/>	<input type="checkbox"/>	<input type="checkbox"/>	<input type="checkbox"/>	<input type="checkbox"/>	<input type="checkbox"/>	<input type="checkbox"/>	<input type="checkbox"/>	<input type="checkbox"/>	<input type="checkbox"/>	<input type="checkbox"/>	<input type="checkbox"/>	<input type="checkbox"/>	<input type="checkbox"/>	<input type="checkbox"/>	<input checked="" type="checkbox"/>	<input type="checkbox"/>	<input type="checkbox"/>	<input type="checkbox"/>	<input type="checkbox"/>	22
23	<input type="checkbox"/>	<input type="checkbox"/>	<input type="checkbox"/>	<input type="checkbox"/>	<input type="checkbox"/>	<input type="checkbox"/>	<input type="checkbox"/>	<input type="checkbox"/>	<input type="checkbox"/>	<input type="checkbox"/>	<input type="checkbox"/>	<input type="checkbox"/>	<input type="checkbox"/>	<input type="checkbox"/>	<input type="checkbox"/>	<input type="checkbox"/>	<input type="checkbox"/>	<input type="checkbox"/>	<input type="checkbox"/>	<input type="checkbox"/>	<input type="checkbox"/>	<input type="checkbox"/>	<input checked="" type="checkbox"/>	<input type="checkbox"/>	<input type="checkbox"/>	<input type="checkbox"/>	23
24	<input type="checkbox"/>	<input type="checkbox"/>	<input type="checkbox"/>	<input type="checkbox"/>	<input type="checkbox"/>	<input type="checkbox"/>	<input type="checkbox"/>	<input type="checkbox"/>	<input type="checkbox"/>	<input type="checkbox"/>	<input type="checkbox"/>	<input type="checkbox"/>	<input type="checkbox"/>	<input type="checkbox"/>	<input type="checkbox"/>	<input type="checkbox"/>	<input type="checkbox"/>	<input type="checkbox"/>	<input type="checkbox"/>	<input type="checkbox"/>	<input type="checkbox"/>	<input type="checkbox"/>	<input type="checkbox"/>	<input checked="" type="checkbox"/>	<input type="checkbox"/>	<input type="checkbox"/>	24
25	<input type="checkbox"/>	<input type="checkbox"/>	<input type="checkbox"/>	<input type="checkbox"/>	<input type="checkbox"/>	<input type="checkbox"/>	<input type="checkbox"/>	<input type="checkbox"/>	<input type="checkbox"/>	<input type="checkbox"/>	<input type="checkbox"/>	<input type="checkbox"/>	<input type="checkbox"/>	<input type="checkbox"/>	<input type="checkbox"/>	<input type="checkbox"/>	<input type="checkbox"/>	<input type="checkbox"/>	<input type="checkbox"/>	<input type="checkbox"/>	<input type="checkbox"/>	<input type="checkbox"/>	<input type="checkbox"/>	<input type="checkbox"/>	<input checked="" type="checkbox"/>	<input type="checkbox"/>	25
26	<input type="checkbox"/>	<input type="checkbox"/>	<input type="checkbox"/>	<input type="checkbox"/>	<input type="checkbox"/>	<input type="checkbox"/>	<input type="checkbox"/>	<input type="checkbox"/>	<input type="checkbox"/>	<input type="checkbox"/>	<input type="checkbox"/>	<input type="checkbox"/>	<input type="checkbox"/>	<input type="checkbox"/>	<input type="checkbox"/>	<input type="checkbox"/>	<input type="checkbox"/>	<input type="checkbox"/>	<input type="checkbox"/>	<input type="checkbox"/>	<input type="checkbox"/>	<input type="checkbox"/>	<input type="checkbox"/>	<input type="checkbox"/>	<input type="checkbox"/>	<input checked="" type="checkbox"/>	26
CPU	<input checked="" type="checkbox"/>	<input checked="" type="checkbox"/>	<input checked="" type="checkbox"/>	<input checked="" type="checkbox"/>	<input checked="" type="checkbox"/>	<input checked="" type="checkbox"/>	<input checked="" type="checkbox"/>	<input checked="" type="checkbox"/>	<input checked="" type="checkbox"/>	<input checked="" type="checkbox"/>	<input checked="" type="checkbox"/>	<input checked="" type="checkbox"/>	<input checked="" type="checkbox"/>	<input checked="" type="checkbox"/>	<input checked="" type="checkbox"/>	<input checked="" type="checkbox"/>	<input checked="" type="checkbox"/>	<input checked="" type="checkbox"/>	<input checked="" type="checkbox"/>	<input checked="" type="checkbox"/>	<input checked="" type="checkbox"/>	<input checked="" type="checkbox"/>	<input checked="" type="checkbox"/>	<input checked="" type="checkbox"/>	<input checked="" type="checkbox"/>	<input checked="" type="checkbox"/>	CPU
	1	2	3	4	5	6	7	8	9	10	11	12	13	14	15	16	17	18	19	20	21	22	23	24	25	26	Apply

Outgoing

Apply | Cancel

Figure 7-8 Port Based VLAN Setup (Port Isolation)

The following table describes the labels in this screen.

Table 7-6 Port Based VLAN Setup

LABEL	DESCRIPTION
Setting Wizard	<p>Choose from All connected or Port isolation.</p> <p>All connected means all ports can communicate with each other, that is, there are no virtual LANs. All incoming and outgoing ports are selected (<i>Figure 7-7</i>). This option is the most flexible but also the least secure.</p> <p>Port isolation means that each port can only communicate with the CPU management port and cannot communicate with each other. All incoming ports are selected while only the CPU outgoing port is selected (<i>Figure 7-8</i>). This option is the most limiting but also the most secure.</p> <p>After you make your selection, click Apply (top right of screen) to display the screens as mentioned above. You can still customize these settings by adding/deleting incoming or outgoing ports, but you must also click Apply at the bottom of the screen.</p>
Incoming	<p>These are the ingress ports; an ingress port is an incoming port, that is, a port through which a data packet enters. If you wish to allow two subscriber ports to talk to each other, you must define the ingress port for both ports. The numbers in the top row denote the incoming port for the corresponding port listed on the left (its outgoing port). CPU refers to the switch management port. By default it forms a VLAN with all Ethernet ports. If it does not form a VLAN with a particular port then the switch cannot be managed from that port.</p>
Outgoing	<p>These are the egress ports; an egress port is an outgoing port, that is, a port through which a data packet leaves. If you wish to allow two subscriber ports to talk to each other, you must define the egress port for both ports. CPU refers to the switch management port. By default it forms a VLAN with all Ethernet ports. If it does not form a VLAN with a particular port then the switch cannot be managed from that port.</p>
Apply	<p>Click Apply to save the changes, including the “wizard settings”.</p>
Cancel	<p>Click Cancel to start configuring the screen again.</p>

Chapter 8

Static MAC Forward Setup

Use these screens to configure static MAC address forwarding.

8.1 Introduction to Static MAC Forward Setup

A static MAC address entry is an address that has been manually entered in the MAC address learning table. Static MAC addresses do not age out. When you set up static MAC address rules, you are setting static MAC addresses for a port. Devices that match static MAC address rules on a port can *only* receive traffic on that port and cannot receive traffic on other ports. This may reduce unicast flooding.

8.2 Configuring Static MAC Forwarding

Click **Static MAC Forwarding** to display the configuration screen as shown.

Figure 8-1 Static MAC Forwarding

The following table describes the labels in this screen.

Table 8-1 Static MAC Forwarding

LABEL	DESCRIPTION
Active	Select this check box to activate your rule. You may temporarily deactivate a rule without deleting it by clearing this check box.
Name	Enter a descriptive name for identification purposes for this static MAC address forwarding rule.

Table 8-1 Static MAC Forwarding

LABEL	DESCRIPTION
MAC Address	Enter the MAC address in valid MAC address format, that is, six hexadecimal character pairs. Static MAC addresses do not age out.
VID	Enter the VLAN identification number.
Port	Select a port where the MAC address entered in the previous field will be automatically forwarded.
Add	Click Add to save the new rule to the switch. It then displays in the summary table at the bottom of the screen.
Cancel	Click Cancel to reset the fields to your previous configuration.
Clear	Click Clear to clear the fields to the factory defaults.

8.3 Viewing and Editing Static MAC Forwarding Rules

To view a summary of the rule configuration, scroll down to the summary table at the bottom of the **Static MAC Forwarding** screen.

To change the settings of a rule, click a number in the **Index** field.

Index	Active	Name	MAC Address	Port	Delete
1	Yes	test	0a:b2:a0:81:f3:7e / 1	3	<input type="checkbox"/>

Delete Cancel

Figure 8-2 Static MAC Forwarding: Summary Table

The following table describes the labels in this screen.

Table 8-2 Static MAC Forwarding: Summary Table

LABEL	DESCRIPTION
Index	Click an index number to modify a static MAC address rule for a port.
Active	This field displays whether this static MAC address forwarding rule is active (Yes) or not (No). You may temporarily deactivate a rule without deleting it.
Name	This field displays the descriptive name for identification purposes for this static MAC address-forwarding rule.
MAC Address	This field displays the MAC address that will be forwarded and the VLAN identification number to which the MAC address belongs.
Port	This field displays the port where the MAC address shown in the next field will be forwarded.
Delete	Check the rule(s) that you want to remove in the Delete column, and then click the Delete button.
Cancel	Click Cancel to clear the selected checkboxes in the Delete column.

Chapter 9

Spanning Tree Protocol

This chapter introduces the Spanning Tree Protocol (STP).

9.1 Introduction to Spanning Tree Protocol (STP)

STP detects and breaks network loops and provides backup links between switches, bridges or routers. It allows a switch to interact with other STP-compliant switches in your network to ensure that only one route exists between any two stations on the network.

9.1.1 STP Terminology

The root bridge is the base of the spanning tree; it is the bridge with the lowest identifier value (MAC address).

Path cost is the cost of transmitting a frame onto a LAN through that port. It is assigned according to the speed of the link to which a port is attached. The slower the media, the higher the cost - see the next table.

Table 9-1 STP Path Costs

	LINK SPEED	RECOMMENDED VALUE	RECOMMENDED RANGE	ALLOWED RANGE
Path Cost	4Mbps	250	100 to 1000	1 to 65535
Path Cost	10Mbps	100	50 to 600	1 to 65535
Path Cost	16Mbps	62	40 to 400	1 to 65535
Path Cost	100Mbps	19	10 to 60	1 to 65535
Path Cost	1Gbps	4	3 to 10	1 to 65535
Path Cost	10Gbps	2	1 to 5	1 to 65535

On each bridge, the root port is the port through which this bridge communicates with the root. It is the port on this switch with the lowest path cost to the root (the root path cost). If there is no root port, then this switch has been accepted as the root bridge of the spanning tree network.

For each LAN segment, a designated bridge is selected. This bridge has the lowest cost to the root among the bridges connected to the LAN.

9.1.2 How STP Works

After a bridge determines the lowest cost-spanning tree with STP, it enables the root port and the ports that are the designated ports for connected LANs, and disables all other ports that participate in STP. Network packets are therefore only forwarded between enabled ports, eliminating any possible network loops.

STP-aware switches exchange Bridge Protocol Data Units (BPDUs) periodically. When the bridged LAN topology changes, a new spanning tree is constructed.

Once a stable network topology has been established, all bridges listen for Hello BPDUs (Bridge Protocol Data Units) transmitted from the root bridge. If a bridge does not get a Hello BPDU after a predefined interval (Max Age), the bridge assumes that the link to the root bridge is down. This bridge then initiates negotiations with other bridges to reconfigure the network to re-establish a valid network topology.

9.1.3 STP Port States

STP assigns five port states (see next table) to eliminate packet looping. A bridge port is not allowed to go directly from blocking state to forwarding state so as to eliminate transient loops.

Table 9-2 STP Port States

PORT STATE	DESCRIPTION
Disabled	STP is disabled (default).
Blocking	Only configuration and management BPDUs are received and processed.
Listening	All BPDUs are received and processed.
Learning	All BPDUs are received and processed. Information frames are submitted to the learning process but not forwarded.
Forwarding	All BPDUs are received and processed. All information frames are received and forwarded.

9.2 STP Status

Click **Advanced Application** and then **Spanning Tree Protocol** in the navigation panel to display the STP status as shown in the screen next.

Spanning Tree Protocol Status [Configuration](#)

Spanning Tree Protocol : Down

Bridge	Root	Our Bridge
Bridge ID	0000-000000000000	0000-000000000000
Hello Time (second)	0	0
Max Age (second)	0	0
Forwarding Delay (second)	0	0
Cost to Bridge	0	
Port ID	0X0000	
Topology Changed Times		0
Time Since Last Change		0:00:00

Polling Interval

Figure 9-1 Spanning Tree Protocol: Status

The following table describes the labels in this screen.

Table 9-3 Spanning Tree Protocol: Status

LABEL	DESCRIPTION
Spanning Tree Protocol	This field displays Running if STP is activated. Otherwise, it displays Down .
Bridge	Root refers to the base of the spanning tree (the root bridge). Our Bridge is this switch. This switch may also be the root bridge.
Bridge ID	This is the unique identifier for this bridge, consisting of bridge priority plus MAC address. This ID is the same for Root and Our Bridge if the switch is the root switch.
Hello Time (second)	This is the time interval (in seconds) at which the root switch transmits a configuration message. The root bridge determines Hello Time , Max Age and Forwarding Delay
Max Age (second)	This is the maximum time (in seconds) a switch can wait without receiving a configuration message before attempting to reconfigure.

Table 9-3 Spanning Tree Protocol: Status

LABEL	DESCRIPTION
Forwarding Delay (second)	This is the time (in seconds) the root switch will wait before changing states (that is, listening to learning to forwarding).
Cost to Bridge	This is the path cost from the root port on this switch to the root switch.
Port ID	This is the priority and number of the port on the switch through which this switch must communicate with the root of the Spanning Tree.
Topology Changed Times	This is the number of times the spanning tree has been reconfigured.
Time Since Last Change	This is the time since the spanning tree was last reconfigured.
Poll Interval(s)	The text box displays how often (in seconds) this screen refreshes. You may change the refresh interval by typing a new number in the text box and then clicking Set Interval .
Stop	Click Stop to halt STP statistic polling.

9.2.1 Configuring STP

To configure STP, click the **Configuration** link in the **Spanning Tree Protocol** screen as shown next.

Spanning Tree Protocol
Status

Active

Bridge Priority

Hello Time Seconds

Max Age Seconds

Forwarding Delay Seconds

Port	Active	Priority	Path Cost
1	<input type="checkbox"/>	128	19
2	<input type="checkbox"/>	128	19
3	<input type="checkbox"/>	128	19
4	<input type="checkbox"/>	128	19
5	<input type="checkbox"/>	128	19
6	<input type="checkbox"/>	128	19
7	<input type="checkbox"/>	128	19
8	<input type="checkbox"/>	128	19
9	<input type="checkbox"/>	128	19
10	<input type="checkbox"/>	128	19
11	<input type="checkbox"/>	128	19
12	<input type="checkbox"/>	128	19
13	<input type="checkbox"/>	128	19
14	<input type="checkbox"/>	128	19
15	<input type="checkbox"/>	128	19
16	<input type="checkbox"/>	128	19

Figure 9-2 Spanning Tree Protocol: Configuring

The following table describes the labels in this screen.

Table 9-4 Spanning Tree Protocol: Configuring

LABEL	DESCRIPTION
Active	Select this check box to activate STP.
Bridge Priority	<p>Bridge priority is used in determining the root switch, root port and designated port. The switch with the highest priority (lowest numeric value) becomes the STP root switch. If all switches have the same priority, the switch with the lowest MAC address will then become the root switch. The allowed range is 0 to 65535.</p> <p>The lower the numeric value you assign, the higher the priority for this bridge.</p> <p>Bridge Priority determines the root bridge, which in turn determines Hello Time, Max Age and Forwarding Delay.</p>
Hello Time	This is the time interval in seconds between BPDU (Bridge Protocol Data Units) configuration message generations by the root switch. The allowed range is 1 to 10 seconds.

Table 9-4 Spanning Tree Protocol: Configuring

LABEL	DESCRIPTION
Max Age	This is the maximum time (in seconds) a switch can wait without receiving a BPDU before attempting to reconfigure. All switch ports (except for designated ports) should receive BPDUs at regular intervals. Any port that ages out STP information (provided in the last BPDU) becomes the designated port for the attached LAN. If it is a root port, a new root port is selected from among the switch ports attached to the network. The allowed range is 6 to 40 seconds.
Forwarding Delay	This is the maximum time (in seconds) a switch will wait before changing states. This delay is required because every switch must receive information about topology changes before it starts to forward frames. In addition, each port needs time to listen for conflicting information that would make it return to a blocking state; otherwise, temporary data loops might result. The allowed range is 4 to 30 seconds. As a general rule:
	$2 * (\text{Forward Delay} - 1) \geq \text{Max Age} \geq 2 * (\text{Hello Time} + 1)$
Port	This field displays the port number.
Active	Select this check box to activate STP on this port.
Priority	Configure the priority for each port here. Priority decides which port should be disabled when more than one port forms a loop in a switch. Ports with a higher priority numeric value are disabled first. The allowed range is between 0 and 255 and default value is 128.
Path Cost	Path cost is the cost of transmitting a frame on to a LAN through that port. It is assigned according to the speed of the bridge. The slower the media, the higher the cost - see <i>Table 9-1</i> for more information.
Apply	Click Apply to save your changes back to the switch.
Cancel	Click Cancel to begin configuring this screen afresh.

Chapter 10

Bandwidth Control

This chapter shows you how you can cap the maximum bandwidth allowed from specific source(s) to specified destination(s) using the Bandwidth Control setup screens.

10.1 Introduction to Bandwidth Control

Bandwidth control means defining a maximum allowable bandwidth for traffic flows going into or going out from individual ports. Click **Advanced Application** and then **Bandwidth Control** in the navigation panel to bring up the screen as shown next.

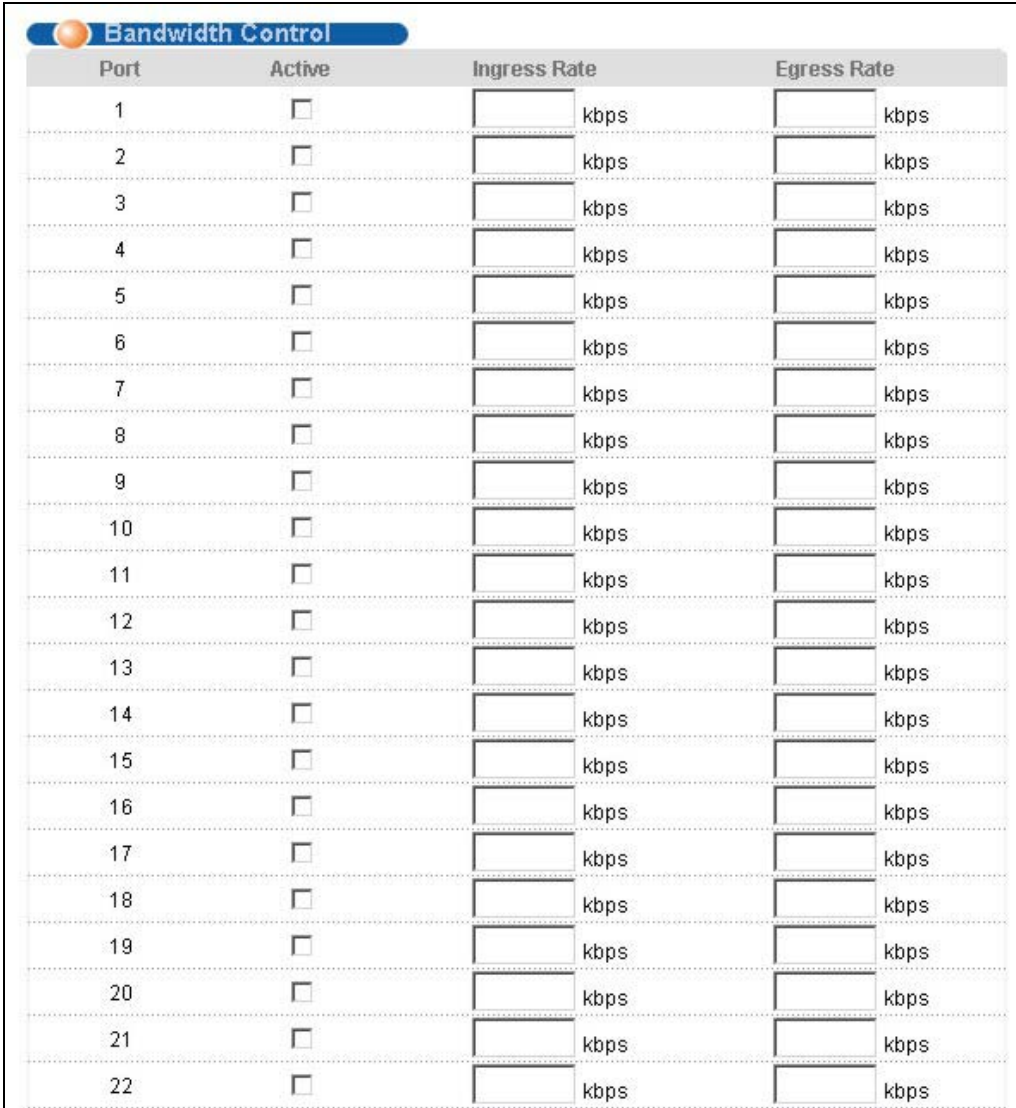

Port	Active	Ingress Rate	Egress Rate
1	<input type="checkbox"/>	<input type="text"/> kbps	<input type="text"/> kbps
2	<input type="checkbox"/>	<input type="text"/> kbps	<input type="text"/> kbps
3	<input type="checkbox"/>	<input type="text"/> kbps	<input type="text"/> kbps
4	<input type="checkbox"/>	<input type="text"/> kbps	<input type="text"/> kbps
5	<input type="checkbox"/>	<input type="text"/> kbps	<input type="text"/> kbps
6	<input type="checkbox"/>	<input type="text"/> kbps	<input type="text"/> kbps
7	<input type="checkbox"/>	<input type="text"/> kbps	<input type="text"/> kbps
8	<input type="checkbox"/>	<input type="text"/> kbps	<input type="text"/> kbps
9	<input type="checkbox"/>	<input type="text"/> kbps	<input type="text"/> kbps
10	<input type="checkbox"/>	<input type="text"/> kbps	<input type="text"/> kbps
11	<input type="checkbox"/>	<input type="text"/> kbps	<input type="text"/> kbps
12	<input type="checkbox"/>	<input type="text"/> kbps	<input type="text"/> kbps
13	<input type="checkbox"/>	<input type="text"/> kbps	<input type="text"/> kbps
14	<input type="checkbox"/>	<input type="text"/> kbps	<input type="text"/> kbps
15	<input type="checkbox"/>	<input type="text"/> kbps	<input type="text"/> kbps
16	<input type="checkbox"/>	<input type="text"/> kbps	<input type="text"/> kbps
17	<input type="checkbox"/>	<input type="text"/> kbps	<input type="text"/> kbps
18	<input type="checkbox"/>	<input type="text"/> kbps	<input type="text"/> kbps
19	<input type="checkbox"/>	<input type="text"/> kbps	<input type="text"/> kbps
20	<input type="checkbox"/>	<input type="text"/> kbps	<input type="text"/> kbps
21	<input type="checkbox"/>	<input type="text"/> kbps	<input type="text"/> kbps
22	<input type="checkbox"/>	<input type="text"/> kbps	<input type="text"/> kbps

Figure 10-1 Bandwidth Control

The following table describes the labels in this screen.

Table 10-1 Bandwidth Control

LABEL	DESCRIPTION
Port	This field displays the port number.
Active	Make sure to select this check box to activate your rule. You may temporarily deactivate a rule without deleting it by clearing this check box.
Ingress Rate	Type the maximum bandwidth allowed in kilobits per second (kbps) for traffic coming into this port.
Egress Rate	Type the maximum bandwidth allowed in kilobits per second (kbps) for traffic going out of this port.
Apply	Click Apply to save your changes back to the switch.
Cancel	Click Cancel to reset the fields to your previous configuration.

Part V

Advanced Application 2

This part shows you how to configure the Broadcast Storm Control, Mirroring, Link Aggregation, Port Authentication, Port Security, Access Control and Queuing Method Advanced Application screens.

Chapter 12

Broadcast Storm Control

12.1 Introducing Broadcast Storm Control

Broadcast storm control limits the percentage of broadcast frames that can be stored in the switch buffer or sent out from the switch. The switch discards broadcast frames that exceed the threshold percentage. Enable this feature to reduce broadcast traffic coming into your network.

12.2 Configuring Broadcast Storm Control

Click **Broadcast Storm Control** in the navigation panel to display the screen as shown next.

Figure 12-1 Broadcast Storm Control

The following table describes the labels in this screen.

Table 12-1 Broadcast Storm Control

LABEL	DESCRIPTION
Active	Select this check box to enable broadcast storm control on the switch.
BSF ON Threshold	Use the drop-down list box to select the Broadcast Storm Filtering (BSF) threshold. The switch starts discarding broadcast frames when the percentage of broadcast frames (out of total frames) exceeds this threshold. The switch discards broadcast frames until the percentage falls back below the threshold.
Apply	Click Apply to save your changes back to the switch.
Cancel	Click Cancel to begin configuring this screen afresh.

Chapter 13

Mirroring

This chapter discusses the Mirror setup screens.

13.1 Introduction to Port Mirroring

Port mirroring allows you to copy traffic from mirrored ports to a monitor port so you can examine the traffic on the monitor port without interfering with the traffic on the mirrored ports.

13.2 Port Mirroring Configuration

Click **Advanced Application** and then **Mirroring** in the navigation panel to display the **Mirroring** screen.

13.2.1 Setting Up Port Mirroring

You must first select a monitor port. A monitor port is a port that copies the traffic of mirrored ports.

Mirroring

Active

Monitor Port Port 1 ▾

Direction Ingress ▾

Port	Mirrored
1	<input type="checkbox"/>
2	<input type="checkbox"/>
3	<input type="checkbox"/>
4	<input type="checkbox"/>
5	<input type="checkbox"/>
6	<input type="checkbox"/>
7	<input type="checkbox"/>
8	<input type="checkbox"/>
9	<input type="checkbox"/>
10	<input type="checkbox"/>
11	<input type="checkbox"/>
12	<input type="checkbox"/>
13	<input type="checkbox"/>
14	<input type="checkbox"/>
15	<input type="checkbox"/>
16	<input type="checkbox"/>
17	<input type="checkbox"/>
18	<input type="checkbox"/>
19	<input type="checkbox"/>
20	<input type="checkbox"/>
21	<input type="checkbox"/>
22	<input type="checkbox"/>
23	<input type="checkbox"/>
24	<input type="checkbox"/>

Figure 13-1 Mirroring

The following table describes the related labels in this screen.

Table 13-1 Mirroring

LABEL	DESCRIPTION
Active	Clear this check box to deactivate port mirroring on the switch.
Monitor Port	The monitor port is the port to which you copy the traffic from mirrored ports. Do this to examine the mirrored ports' traffic in more detail without interfering with the traffic flow on the mirrored port(s). Select a monitor port from this drop-down list box.

Table 13-1 Mirroring

LABEL	DESCRIPTION
Direction	Select which direction of traffic you want to copy from the mirrored port(s) to the monitor port. Select Ingress to copy the traffic coming into the switch through the mirrored port(s). Select Egress to copy the traffic going out of the switch through the mirrored port(s). Select Both to copy the traffic coming into or going out of the switch through the mirrored port(s).
Port	A mirrored port is a port from which you copy the traffic to the monitor port. Do this to examine the mirrored port's traffic in more detail without interfering with the traffic flow on the mirrored port. Select the Mirrored check box for each port from which you want to copy traffic. You can select more than one mirrored port.
Apply	Click Apply to save the changes.
Cancel	Click Cancel to start configuring the screen again.

Chapter 14

Link Aggregation

This chapter shows you how to logically aggregate physical links to form one logical, higher-bandwidth link.

14.1 Introduction to Link Aggregation

Link aggregation (trunking) is the grouping of physical ports into one logical higher-capacity link. You may want to aggregate ports if for example, it is cheaper to use multiple lower-speed links than to under-utilize a high-speed, but more costly, single-port link.

However, the more ports you aggregate then the fewer available ports you have. A link aggregation group is one logical link containing multiple ports.

A link aggregation group can have up to four member ports.

14.1.1 Dynamic Link Aggregation

The ES-2024 adheres to the 802.3ad standard for static and dynamic (LACP) port aggregation.

The ES-2024 supports the link aggregation IEEE802.3ad standard. This standard describes the Link Aggregate Control Protocol (LACP), which is a protocol that dynamically creates and manages link aggregation groups.

When you enable LACP link aggregation on a port, the port can automatically negotiate with the ports at the remote end of a link to establish link aggregation groups. LACP also allows port redundancy, that is, if an operational port fails, then one of the “standby” ports become operational without user intervention

Please note that:

- You must connect all ports point-to-point to the same Ethernet switch and configure the ports for LACP aggregation.
- LACP only works on full-duplex links.
- All ports in the same link aggregation group must have the same media type, speed, duplex mode and flow control settings.

Configure link aggregation groups or LACP before you connect the Ethernet switch to avoid causing network topology loops.

14.1.2 Link Aggregation ID

LACP aggregation ID consists of the following information:

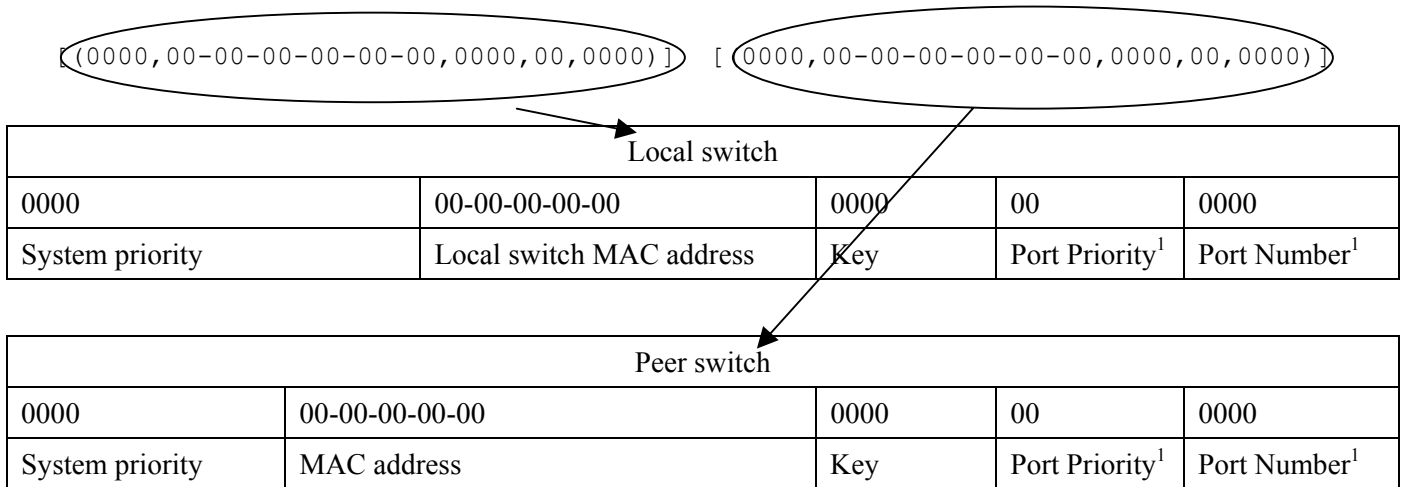

Figure 14-1 Aggregation ID

14.2 Link Aggregation Protocol Status

Click **Link Aggregation** in the navigation panel to display the **Link Aggregation Protocol Status** screen.

¹ This is “0” as it is the aggregator ID for the link aggregation group, not the individual port.

Link Aggregation Control Protocol Status		Configuration	
Index	Aggregator ID	Enabled Ports	Synchronized Ports
1	[(0000,00-00-00-00-00-00-00,0000,00,0000)] [(0000,00-00-00-00-00-00,0000,00,0000)]	-	-
2	[(0000,00-00-00-00-00-00-00,0000,00,0000)] [(0000,00-00-00-00-00-00,0000,00,0000)]	-	-
3	[(0000,00-00-00-00-00-00-00,0000,00,0000)] [(0000,00-00-00-00-00-00,0000,00,0000)]	-	-
4	[(0000,00-00-00-00-00-00-00,0000,00,0000)] [(0000,00-00-00-00-00-00,0000,00,0000)]	-	-
5	[(0000,00-00-00-00-00-00-00,0000,00,0000)] [(0000,00-00-00-00-00-00,0000,00,0000)]	-	-
6	[(0000,00-00-00-00-00-00-00,0000,00,0000)] [(0000,00-00-00-00-00-00,0000,00,0000)]	-	-
7	[(0000,00-00-00-00-00-00-00,0000,00,0000)] [(0000,00-00-00-00-00-00,0000,00,0000)]	-	-

Polling Interval(s)

Figure 14-2 Link Aggregation: Link Aggregation Protocol Status

The following table describes the labels in this screen.

Table 14-1 Link Aggregation: Link Aggregation Protocol Status

LABEL	DESCRIPTION
Index	This field displays the link aggregation ID to identify a link aggregation group, that is, one logical link containing multiple ports.
Aggregator ID	Refer to <i>Figure 14-1</i> for more information on this field.
Enabled Ports	These are the ports you have configured in the Link Aggregation screen to be in the link aggregation group.
Synchronized Ports	These are the ports that are currently transmitting data as one logical link in this link aggregation group.
Poll Interval(s)	The text box displays how often (in seconds) this screen refreshes. You may change the refresh interval by typing a new number in the text box and then clicking Set Interval .
Stop	Click Stop to halt statistic polling.

14.3 Link Aggregation Setup

Click **Configuration** in the **Link Aggregation Protocol Status** screen to display the screen shown next.

Link Aggregation
Status

Link Aggregation Control Protocol

Active

System Priority

Group ID	Active	Dynamic(LACP)
T1	<input type="checkbox"/>	<input type="checkbox"/>
T2	<input type="checkbox"/>	<input type="checkbox"/>
T3	<input type="checkbox"/>	<input type="checkbox"/>
T4	<input type="checkbox"/>	<input type="checkbox"/>
T5	<input type="checkbox"/>	<input type="checkbox"/>
T6	<input type="checkbox"/>	<input type="checkbox"/>
T7	<input type="checkbox"/>	<input type="checkbox"/>

Port	Group	LACP Timeout
1	None ▼	30 ▼ seconds
2	None ▼	30 ▼ seconds
3	None ▼	30 ▼ seconds
4	None ▼	30 ▼ seconds
5	None ▼	30 ▼ seconds
6	None ▼	30 ▼ seconds
7	None ▼	30 ▼ seconds
8	None ▼	30 ▼ seconds
9	None ▼	30 ▼ seconds
10	None ▼	30 ▼ seconds
11	None ▼	30 ▼ seconds

Figure 14-3 Link Aggregation: Configuration

The following table describes the labels in this screen.

Table 14-2 Link Aggregation: Configuration

LABEL	DESCRIPTION
Link Aggregation Control Protocol	

Table 14-2 Link Aggregation: Configuration

LABEL	DESCRIPTION
Active	Select this checkbox to enable Link Aggregation Control Protocol (LACP).
System Priority	LACP system priority is a number between 1 and 65,355. The switch with the lowest system priority (and lowest port number if system priority is the same) becomes the LACP “server”. The LACP “server” controls the operation of LACP setup. Enter a number to set the priority of an active port using Link Aggregate Control Protocol (LACP). The smaller the number, the higher the priority level.
Group ID	The index identifies the link aggregation group, that is, one logical link containing multiple ports.
Active	Make sure to select this check box to activate the link aggregation group. You may temporarily deactivate a link aggregation group without deleting it by clearing this check box.
Dynamic(LACP)	Select this check box to enable LACP for a link aggregation group.
Port	These are the switch’s ports.
Group	Use this drop-down list box to add the port to one of the link aggregation groups. A single link aggregation group can have up to four ports.
LACP Timeout	<p>Timeout is the time interval between the individual port exchanges of LACP packets in order to check that the peer port in the link aggregation group is still up. If a port does not respond after three tries, then it is deemed to be “down” and is removed from the link aggregation group. Set a short timeout (one second) for busy aggregated links to ensure that disabled ports are removed from the link aggregation group as soon as possible.</p> <p>Select either 1 second or 30 seconds.</p> <p>The LACP timeout must be the same for all members of a link aggregation group.</p>
Apply	Click Apply to save your changes back to the switch.
Cancel	Click Cancel to begin configuring this screen afresh.

Chapter 15

Port Authentication

This chapter describes the 802.1x authentication method and RADIUS server connection setup.

15.1 Introduction to Authentication

IEEE 802.1x is an extended authentication protocol² that allows support of RADIUS (Remote Authentication Dial In User Service, RFC 2138, 2139) for centralized user profile management on a network RADIUS server.

15.1.1 RADIUS

RADIUS (Remote Authentication Dial-In User Service) authentication is a popular protocol used to authenticate users by means of an external server instead of (or in addition to) an internal device user database that is limited to the memory capacity of the device. In essence, RADIUS authentication allows you to validate an unlimited number of users from a central location.

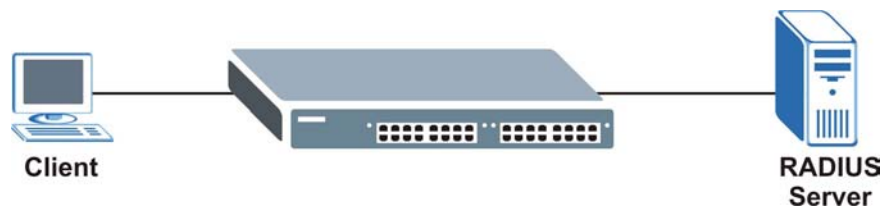

Figure 15-1 RADIUS Server

15.2 Configuring Port Authentication

To enable port authentication, first activate IEEE802.1x security (both on the ES-2024 and the port(s)) then configure the RADIUS server settings.

Click **Port Authentication** under **Advanced Application** in the navigation panel to display the screen as shown.

² At the time of writing, Windows XP of the Microsoft operating systems supports 802.1x. See the Microsoft web site for information on other Windows operating system support. For other operating systems, see its documentation. If your operating system does not support 802.1x, then you may need to install 802.1x client software.



Figure 15-2 Port Authentication

15.2.1 Configuring RADIUS Server Settings

From the **Port Authentication** screen, click **RADIUS** to display the configuration screen as shown.

Figure 15-3 Port Authentication: RADIUS

The following table describes the labels in this screen.

Table 15-1 Port Authentication: RADIUS

LABEL	DESCRIPTION
Authentication Server	
IP Address	Enter the IP address of the external RADIUS server in dotted decimal notation.
UDP Port	The default port of the RADIUS server for authentication is 1812 . You need not change this value unless your network administrator instructs you to do so.
Shared Secret	Specify a password (up to 31 alphanumeric characters) as the key to be shared between the external RADIUS server and the switch. This key is not sent over the network. This key must be the same on the external RADIUS server and the switch.
Apply	Click Apply to save your changes back to the switch.
Cancel	Click Cancel to begin configuring this screen afresh.

15.2.2 Configuring IEEE802.1x

From the **Port Authentication** screen, click **802.1x** to display the configuration screen as shown.

802.1x
Port Authentication

Active

Port	Active	Reauthentication	Reauthentication Timer
1	<input type="checkbox"/>	On ▼	3600 seconds
2	<input type="checkbox"/>	On ▼	3600 seconds
3	<input type="checkbox"/>	On ▼	3600 seconds
4	<input type="checkbox"/>	On ▼	3600 seconds
5	<input type="checkbox"/>	On ▼	3600 seconds
6	<input type="checkbox"/>	On ▼	3600 seconds
7	<input type="checkbox"/>	On ▼	3600 seconds
8	<input type="checkbox"/>	On ▼	3600 seconds
9	<input type="checkbox"/>	On ▼	3600 seconds
10	<input type="checkbox"/>	On ▼	3600 seconds
11	<input type="checkbox"/>	On ▼	3600 seconds
12	<input type="checkbox"/>	On ▼	3600 seconds
13	<input type="checkbox"/>	On ▼	3600 seconds
14	<input type="checkbox"/>	On ▼	3600 seconds
15	<input type="checkbox"/>	On ▼	3600 seconds
16	<input type="checkbox"/>	On ▼	3600 seconds
17	<input type="checkbox"/>	On ▼	3600 seconds
18	<input type="checkbox"/>	On ▼	3600 seconds
19	<input type="checkbox"/>	On ▼	3600 seconds
20	<input type="checkbox"/>	On ▼	3600 seconds
21	<input type="checkbox"/>	On ▼	3600 seconds
22	<input type="checkbox"/>	On ▼	3600 seconds
23	<input type="checkbox"/>	On ▼	3600 seconds
24	<input type="checkbox"/>	On ▼	3600 seconds
25	<input type="checkbox"/>	On ▼	3600 seconds
26	<input type="checkbox"/>	On ▼	3600 seconds

Figure 15-4 Port Authentication: 802.1x

The following table describes the labels in this screen.

Table 15-2 Port Authentication: 802.1x

LABEL	DESCRIPTION
Active	Select this check box to permit 802.1x authentication on the switch.
	You must first allow 802.1x authentication on the switch before configuring it on each port.
Port	This field displays a port number.
Active	Select this checkbox to permit 802.1x authentication on this port. You must first allow 802.1x authentication on the switch before configuring it on each port.
Reauthentication	Specify if a subscriber has to periodically re-enter his or her username and password to stay connected to the port.
Reauthentication Timer	Specify how often a client has to re-enter his or her username and password to stay connected to the port.
Apply	Click Apply to save your changes back to the switch.
Cancel	Click Cancel to begin configuring this screen afresh.

Chapter 16 Port Security

This chapter shows you how to set up port security.

16.1 About Port Security

Port security allows only frames from the static MAC addresses configured for the ports to pass through the switch. The switch can learn up to 10K MAC addresses in total with no limit on individual ports other than the sum cannot exceed 10K.

For maximum port security, enable this feature, disable MAC address learning and configure static MAC address(es) for a port.

16.2 Port Security Setup

Click **Port Security** in the navigation panel to display the screen as shown.

Port	Active
1	<input type="checkbox"/>
2	<input type="checkbox"/>
3	<input type="checkbox"/>
4	<input type="checkbox"/>
5	<input type="checkbox"/>
6	<input type="checkbox"/>
7	<input type="checkbox"/>
8	<input type="checkbox"/>
9	<input type="checkbox"/>
10	<input type="checkbox"/>
11	<input type="checkbox"/>
12	<input type="checkbox"/>
13	<input type="checkbox"/>
14	<input type="checkbox"/>
15	<input type="checkbox"/>
16	<input type="checkbox"/>
17	<input type="checkbox"/>
18	<input type="checkbox"/>
19	<input type="checkbox"/>
20	<input type="checkbox"/>
21	<input type="checkbox"/>
22	<input type="checkbox"/>
23	<input type="checkbox"/>
24	<input type="checkbox"/>
25	<input type="checkbox"/>
26	<input type="checkbox"/>

Figure 16-1 Port Security

The following table describes the labels in this screen.

Table 16-1 Port Security

LABEL	DESCRIPTION
Port	This field displays a port number.
Active	Select this check box to have this port only accept frames from static MAC addresses that are configured for the port. The switch will drop frames from MAC addresses that are not statically configured for the port.
Apply	Click Apply to save your changes back to the switch.
Cancel	Click Cancel to begin configuring this screen afresh.

Chapter 17

Access Control

This chapter describes how to control access to the switch.

17.1 About Access Control

Click **Access Control** from the navigation panel to display the screen as shown. From this screen you can configure SNMP, up to four web configurator administrators, enable/disable remote service access and configure trusted computers for remote access.



Figure 17-1 Access Control

17.2 Access Control Overview

1. A console port access control session and Telnet access control session cannot coexist. The console port has higher priority. If you telnet to the switch and someone is already logged in from the console port, then you will see the following message.

```
"Local administrator is configuring this device now!!!  
Connection to host lost."
```

Figure 17-2 Console Port Priority

2. A console port or Telnet session can coexist with one FTP session, up to five Web sessions (five different usernames and passwords) and/or limitless SNMP access control sessions.

Table 17-1 Access Control Summary

	Console port	Telnet	FTP	Web	SNMP
Number of sessions allowed	1	1	1	5	No limit
Number of concurrent sessions allowed	1 console port or Telnet. Console port has priority.		1	5	No limit

17.3 About SNMP

Simple Network Management Protocol is a protocol used for exchanging management information between network switches. SNMP is a member of TCP/IP protocol suite. A manager station can manage and monitor the ES-2024 through the network via SNMP version one (SNMPv1) and/or SNMP version 2c. The next figure illustrates an SNMP management operation. SNMP is only available if TCP/IP is configured.

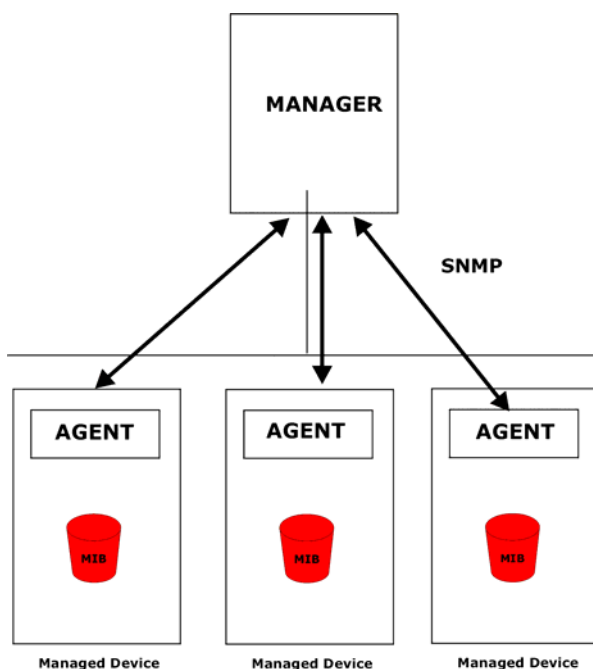
**Figure 17-3 SNMP Management Model**

An SNMP managed network consists of two main components: agents and a manager.

An agent is a management software module that resides in a managed switch (the ES-2024). An agent translates the local management information from the managed switch into a form compatible with SNMP. The manager is the console through which network administrators perform network management functions. It executes applications that control and monitor managed devices.

The managed devices contain object variables/managed objects that define each piece of information to be collected about a switch. Examples of variables include such as number of packets received, node port status etc. A

Management Information Base (MIB) is a collection of managed objects. SNMP allows a manager and agents to communicate for the purpose of accessing these objects.

SNMP itself is a simple request/response protocol based on the manager/agent model. The manager issues a request and the agent returns responses using the following protocol operations:

Table 17-2 SNMP Commands

COMMAND	DESCRIPTION
Get	Allows the manager to retrieve an object variable from the agent.
GetNext	Allows the manager to retrieve the next object variable from a table or list within an agent. In SNMPv1, when a manager wants to retrieve all elements of a table from an agent, it initiates a Get operation, followed by a series of GetNext operations.
Set	Allows the manager to set values for object variables within an agent.
Trap	Used by the agent to inform the manager of some events.

17.3.1 Supported MIBs

MIBs let administrators collect statistics and monitor status and performance.

The ES-2024 supports the following MIBs:

- SNMP MIB II (RFC 1213)
- RFC 1157 SNMP v1
- RFC 1493 Bridge MIBs
- RFC 1643 Ethernet MIBs
- RFC 1155 SMI
- RFC 2674 SNMPv2, SNMPv2c
- RFC 1757 RMON

17.3.2 SNMP Traps

The ES-2024 sends traps to an SNMP manager when an event occurs. SNMP traps supported are outlined in the following table.

Table 17-3 SNMP Traps

GENERIC TRAP	SPECIFIC TRAP	DESCRIPTION
0 (Cold Start)	0	This trap is sent when the ES-2024 is turned on.
1 (WarmStart)	0	This trap is sent when the ES-2024 restarts.
2 (linkDown)	0	This trap is sent when the Ethernet link is down.
3 (linkUp)	0	This trap is sent when the Ethernet link is up.
4 (authenticationFailure)	0	This trap is sent when an SNMP request comes from non-authenticated hosts.

17.3.3 Configuring SNMP

From the **Access Control** screen, display the **SNMP** screen. You can click **Access Control** to go back to the **Access Control** screen.

Figure 17-4 Access Control: SNMP

The following table describes the labels in this screen.

Table 17-4 Access Control: SNMP

LABEL	DESCRIPTION
Get Community	Enter the get community, which is the password for the incoming Get- and GetNext- requests from the management station.
Set Community	Enter the set community, which is the password for incoming Set- requests from the management station.
Trap: Community	Enter the trap community, which is the password sent with each trap to the SNMP manager.
Trap: Destination	Enter the IP addresses of up to four stations to send your SNMP traps to.
Apply	Click Apply to save your changes back to the switch.
Cancel	Click Cancel to begin configuring this screen afresh.

17.3.4 Setting Up Login Accounts

Up to five people (one administrator and four non-administrators) may access the switch via web configurator at any one time.

1. An administrator is someone who can both view and configure switch changes. The username for the Administrator is always **admin**. The default administrator password is **1234**.

It is highly recommended that you change the default administrator password ("1234").

2. A non-administrator (username is something other than **admin**) is someone who can view but not configure switch changes.

Click **Access Control** from the navigation panel and then click Logins from this screen.

Logins Access Control

Administrator

Old Password

New Password

Retype to confirm

Please record your new password whenever you change it. The system will lock you out if you have forgotten your password.

Edit Logins

Login	User Name	Password	Retype to confirm
1	<input type="text"/>	<input type="text"/>	<input type="text"/>
2	<input type="text"/>	<input type="text"/>	<input type="text"/>
3	<input type="text"/>	<input type="text"/>	<input type="text"/>
4	<input type="text"/>	<input type="text"/>	<input type="text"/>

Figure 17-5 Access Control: Logins

The following table describes the labels in this screen.

Table 17-5 Access Control: Logins

LABEL	DESCRIPTION
Administrator	This is the default administrator account with the “admin” user name. You cannot change the default administrator user name. Only the administrator has read/write access.
Old Password	Type the existing system password (“1234” is the default password when shipped).
New Password	Enter your new system password.
Retype to confirm	Retype your new system password for confirmation
Edit Logins	You may configure passwords for up to four users. These people have read-only access.
User Name	Set a user name (up to 30 characters long).
Password	Enter your new system password.
Retype to confirm	Retype your new system password for confirmation
Apply	Click Apply to save your changes back to the switch.

Table 17-5 Access Control: Logins

LABEL	DESCRIPTION
Cancel	Click Cancel to begin configuring this screen afresh.

17.4 Service Access Control

Service Access Control allows you to decide what services you may use to access the ES-2024. You may also configure “trusted computer(s)” for each service in the **Remote Management** screen (discussed later). Click **Access Control** to go back to the **Access Control** screen.

Services	Active	Service Port
Telnet	<input checked="" type="checkbox"/>	23
FTP	<input checked="" type="checkbox"/>	21
Web	<input checked="" type="checkbox"/>	80
ICMP	<input checked="" type="checkbox"/>	
SNMP	<input checked="" type="checkbox"/>	

Figure 17-6 Access Control: Service Access Control

The following table describes the fields in this screen.

Table 17-6 Access Control: Service Access Control

LABEL	DESCRIPTION
Services	Services you may use to access the ES-2024 are listed here.
Enable	Select the Enable check boxes for the corresponding services that you want to allow to access the ES-2024.
Server Port	For Telnet, FTP or web services, you may change the default service port by typing the new port number in the Server Port field. If you change the default port number then you will have to let people (who wish to use the service) know the new port number for that service.
Apply	Click Apply to save your changes back to the switch.
Cancel	Click Cancel to begin configuring this screen afresh.

17.5 Remote Management

From the **Access Control** screen, display the **Remote Management** screen as shown next.

You can specify a group of one or more “trusted computers” from which an administrator may use a service to manage the switch. Click **Access Control** to return to the **Access Control** screen.

Entry	Active	Start Address	End Address	Telnet	FTP	Web	ICMP	SNMP
1	<input checked="" type="checkbox"/>	0.0.0.0	0.0.0.0	<input checked="" type="checkbox"/>	<input checked="" type="checkbox"/>	<input checked="" type="checkbox"/>	<input checked="" type="checkbox"/>	<input checked="" type="checkbox"/>
2	<input type="checkbox"/>	0.0.0.0	0.0.0.0	<input type="checkbox"/>	<input type="checkbox"/>	<input type="checkbox"/>	<input type="checkbox"/>	<input type="checkbox"/>
3	<input type="checkbox"/>	0.0.0.0	0.0.0.0	<input type="checkbox"/>	<input type="checkbox"/>	<input type="checkbox"/>	<input type="checkbox"/>	<input type="checkbox"/>
4	<input type="checkbox"/>	0.0.0.0	0.0.0.0	<input type="checkbox"/>	<input type="checkbox"/>	<input type="checkbox"/>	<input type="checkbox"/>	<input type="checkbox"/>

Figure 17-7 Access Control: Remote Management

The following table describes the labels in this screen.

Table 17-7 Access Control: Remote Management

LABEL	DESCRIPTION
Entry	This is the client set index number. A “client set” is a group of one or more “trusted computers” from which an administrator may use a service to manage the switch.
Active	Select this check box to activate this secured client set. Clear the check box if you wish to temporarily disable the set without deleting it.
Start Address	Configure the IP address range of trusted computers fro which you can manage this switch.
End Address	The switch checks if the client IP address of a computer requesting a service or protocol matches the range set here. The switch immediately disconnects the session if it does not match.
Telnet/FTP/Web/ CMP/SNMP	Select services that may be used for managing the switch from the specified trusted computers.
Apply	Click Apply to save your changes back to the switch.
Cancel	Click Cancel to begin configuring this screen afresh.

Chapter 18

Queuing Method

This chapter introduces the switch's queuing algorithms.

18.1 Introduction to Queuing

Queuing is used to help solve performance degradation when there is network congestion. Use the **Queuing Method** screen to configure queuing algorithms for outgoing traffic. See also **Priority Queue Assignment** in **Switch Setup** and **Priority** in **Port Setup** for related information.

Queuing algorithms allow switches to maintain separate queues for packets from each individual source or flow and prevent a source from monopolizing the bandwidth.

The switch has two physical queues, high and low.

18.1.1 First Come First Serve

First come first serve queuing treats all traffic with the same priority. The switch transmits the traffic in the order it receives it. The high-priority queue does not get any priority over the low-priority queue.

18.1.2 Strict Priority Queuing

Strict priority queuing services queues based on priority only. As traffic comes into the switch, traffic in the high-priority queue is transmitted first. When the high-priority queue empties, traffic in the low-priority queue, is transmitted until the low-priority queue empties. If the high-priority queue never empties, then traffic in the low-priority queue never gets sent. Strict priority queuing does not automatically adapt to changing network requirements.

18.1.3 Weighted Round Robin Scheduling

Weighted round robin scheduling services queues based on the ratio determined by their queue weights (the numbers you configure in the **High Weight** or **Low Weight** field – see *Figure 18-1*). A queue with a larger weight gets more service than a queue with a smaller weight. This queuing mechanism is highly efficient in that it divides the available bandwidth across the different traffic queues. If one queue is empty, the switch just sends from the other queue. See *section 18.3* for an example of weighted round robin scheduling.

18.2 Configuring Queuing

Click **Queuing Method** under **Advanced Application** in the navigation panel.

Figure 18-1 Queuing Method

The following table describes the labels in this screen.

Table 18-1 Queuing Method

LABEL	DESCRIPTION
Method	<p>Select First Come First Serve, Strictly Priority or Weighted Round Robin Scheduling.</p> <p>First come first serve queuing treats all traffic with the same priority. The switch transmits the traffic in the order it receives it. The high-priority queue does not get any priority over the low-priority queue.</p> <p>Strictly priority queuing services queues based on priority only. When the high-priority queue empties, traffic on the low-priority queue begins.</p> <p>Weighted round robin scheduling services queues based on the ratio determined by their queue weights that you configure in the High Weight and Low Weight fields. Bandwidth is divided between the high and low traffic queues according to their weights. A queue with a larger weight gets more service than a queue with a smaller weight.</p>
High Weight	<p>Configure this field when you select Weighted Round Robin Scheduling in the Method field.</p> <p>Select a weight (1-7) for the high-priority queue traffic. This sets the ratio of how much high-priority queue traffic the switch transmits in relation to the amount of low-priority queue traffic (see the Low Weight field).</p>
Low Weight	<p>Configure this field when you select Weighted Round Robin Scheduling in the Method field.</p> <p>Select a weight (1-7) for the low-priority queue traffic. This sets the ratio of how much low-priority queue traffic the switch transmits in relation to the amount of high-priority queue traffic (see the High Weight field).</p>
Apply	Click Apply to save your changes back to the switch.
Cancel	Click Cancel to begin configuring this screen afresh.

18.3 Weighted Round Robin Scheduling Example

This is an example of using **Weighted Round Robin Scheduling** as the queuing method. In this example the high-priority traffic's weight is set to **5** and the low-priority traffic's weight is set to **3**.

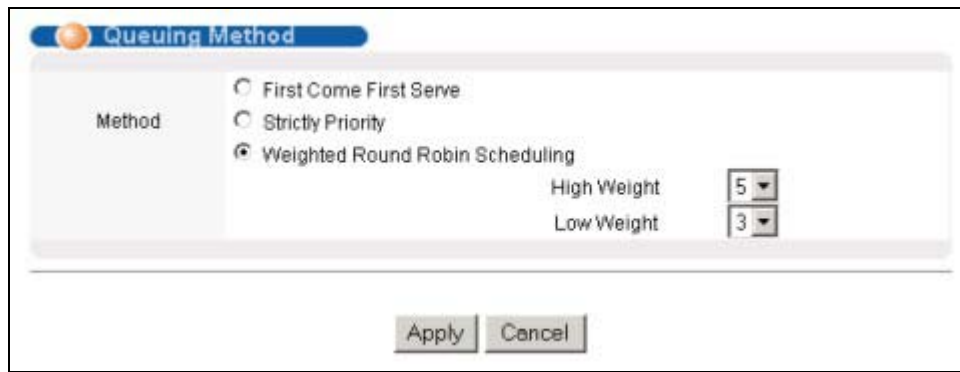

Figure 18-2 Weighted Round Robin Scheduling Configuration Example

With this configuration, the switch sends five frames from the high-priority queue for every three frames it sends from the low-priority queue (on average). In other words, as long as both queues are full, on average five eighths of the frames the switch sends are from the high-priority queue and three eighths are from the low-priority queue.

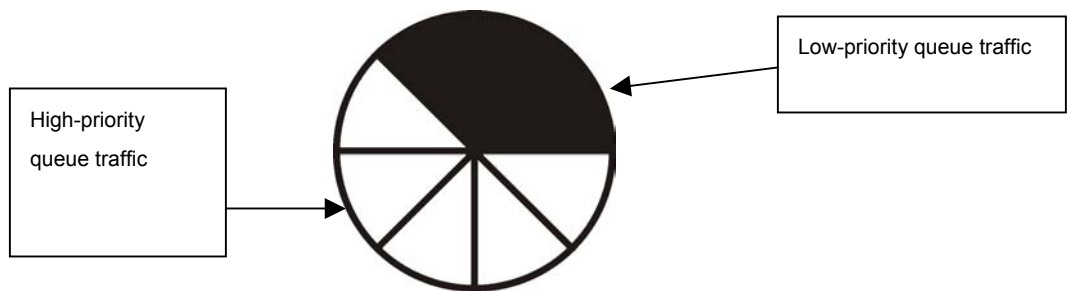

Figure 18-3 Weighted Round Robin Scheduling Ratio Example

Part VI

Routing Protocol and Management

This part describes the Routing Protocol and Management screens.

Chapter 19

Routing Protocol

This chapter shows you how to configure the static routing function.

19.1 Static Route

Static routes tell the ES-2024 how to forward the ES-2024's own IP traffic when you configure the TCP/IP parameters manually. This is generally useful for allowing management of the switch from a device with an IP address on a different subnet from that of the switch's IP address (remote management).

Click **Routing Protocol** in the navigation panel and then **Static Routing** to display the screen as shown.

The screenshot displays the 'Static Routing' configuration page. At the top, there is a title bar with an orange circle and the text 'Static Routing'. Below this is a form with the following fields:

- Active:
- Name:
- Destination IP Address:
- IP Subnet Mask:
- Gateway IP Address:
- Metric:

Below the form are three buttons: 'Add', 'Cancel', and 'Clear'. Underneath these buttons is a table with the following data:

Index	Active	Name	Destination Address	Subnet Mask	Gateway Address	Metric	Delete
1	Yes	ju	172.16.1.2	255.255.0.0	192.168.1.2	2	<input type="checkbox"/>

Below the table are two buttons: 'Delete' and 'Cancel'.

Figure 19-1 Static Routing

The following table describes the related labels you use to create a static route.

Table 19-1 Static Routing

LABEL	DESCRIPTION
Active	This field allows you to activate/deactivate this static route.
Name	Enter a descriptive name for this route. This is for identification purpose only.

Table 19-1 Static Routing

LABEL	DESCRIPTION
Destination IP Address	This parameter specifies the IP network address of the final destination. Routing is always based on network number. If you need to specify a route to a single host, use a subnet mask of 255.255.255.255 in the subnet mask field to force the network number to be identical to the host ID.
IP Subnet Mask	Enter the subnet mask for this destination.
Gateway IP Address	Enter the IP address of the gateway. The gateway is an immediate neighbor of your switch that will forward the packet to the destination. The gateway must be a router on the same segment as your switch.
Metric	The metric represents the “cost” of transmission for routing purposes. IP routing uses hop count as the measurement of cost, with a minimum of 1 for directly connected networks. Enter a number that approximates the cost for this link. The number need not be precise, but it must be between 1 and 15. In practice, 2 or 3 is usually a good number.
Add	Click Add to save the new rule to the switch. It then displays in the summary table at the bottom of the screen.
Cancel	Click Cancel to reset the fields to your previous configuration.
Clear	Click Clear to clear the fields to the factory defaults.

View the current static routes on the switch in the summary table at the bottom of the screen.

Index	Active	Name	Destination Address	Subnet Mask	Gateway Address	Metric	Delete
1	Yes	ju	172.16.1.2	255.255.0.0	192.168.1.2	2	<input type="checkbox"/>

Figure 19-2 Static Routing: Summary Table

The following table describes the labels in the summary table.

Table 19-2 Static Routing: Summary Table

LABEL	DESCRIPTION
Index	This field displays the index number of the route. Click a number to edit the static route entry.
Active	This field displays Yes when the static route is activated and NO when is it deactivated.
Name	This field displays the descriptive name for this route. This is for identification purpose only.
Destination Address	This field displays the IP network address of the final destination.
Subnet Mask	This field displays the subnet mask for this destination.

Table 19-2 Static Routing: Summary Table

LABEL	DESCRIPTION
Gateway Address	This field displays the IP address of the gateway. The gateway is an immediate neighbor of your switch that will forward the packet to the destination.
Metric	This field displays the cost of transmission for routing purposes.
Delete	Check the rule(s) that you want to remove in the Delete column, and then click the Delete button.
Cancel	Click Cancel to clear the selected checkboxes in the Delete column.

Chapter 20

Maintenance

This chapter explains how to configure the maintenance screens. The links on the upper right of the Maintenance screen lead to different screens that let you maintain the firmware and configuration files.

20.1 Maintenance

Click **Management** and then **Maintenance** in the navigation panel to open the following screen.



Figure 20-1 Maintenance

20.2 Firmware Upgrade

Click **Firmware Upgrade** in the **Maintenance** screen if you want to upgrade your switch firmware. See the **System Info** screen to verify your current firmware version number. Make sure you have downloaded (and unzipped) the correct model firmware and version to your computer before uploading to the device.

Be sure to upload the correct model firmware as uploading the wrong model firmware may damage your device.

From the **Maintenance** screen, display the **Firmware Upgrade** screen as shown next.

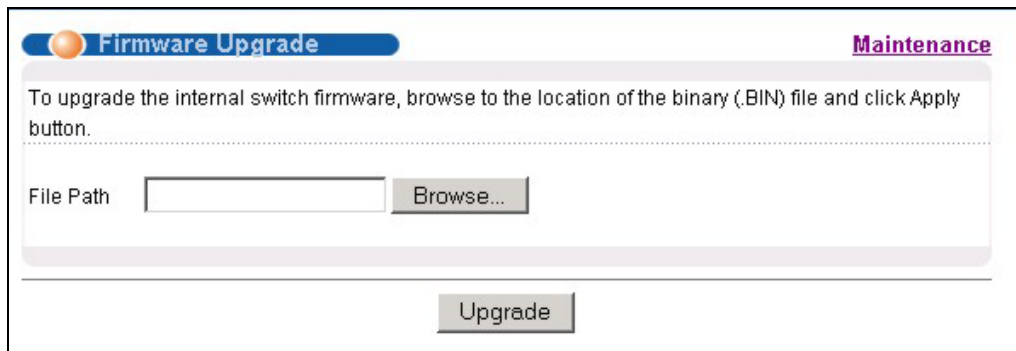
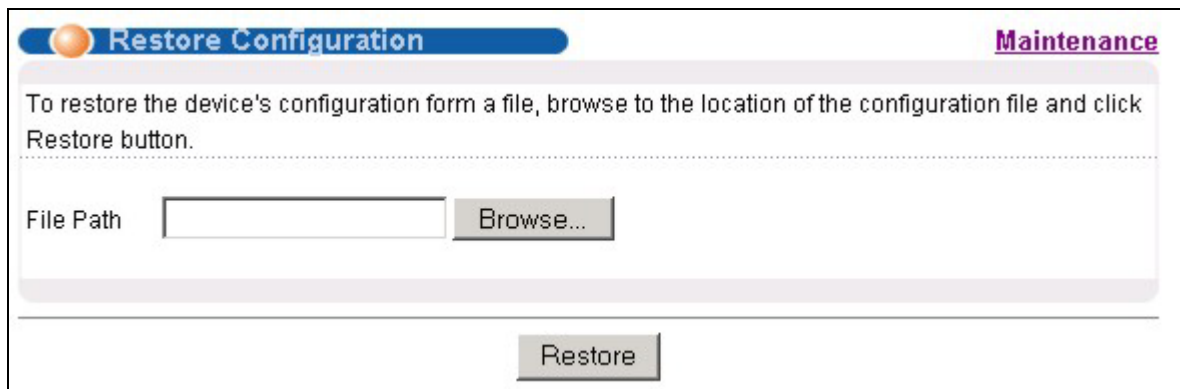

Figure 20-2 Firmware Upgrade

Type the path and file name of the firmware file you wish to upload to the switch in the **File Path** text box or click **Browse** to locate it. After you have specified the file, click **Upgrade**.

20.3 Restore a Configuration File

Restore a previously saved configuration from your computer to the switch using the **Restore Configuration** screen.



The screenshot shows a web interface for restoring a configuration. At the top, there is a blue header with an orange circle icon, the text "Restore Configuration", and a purple "Maintenance" link. Below the header, a light gray box contains the instruction: "To restore the device's configuration form a file, browse to the location of the configuration file and click Restore button." Underneath this instruction is a "File Path" label followed by a text input field and a "Browse..." button. At the bottom center of the interface is a "Restore" button.

Figure 20-3 Restore Configuration

Type the path and file name of the configuration file you wish to restore in the **File Path** text box or click **Browse** to display a **Choose File** screen from which you can locate it. After you have specified the file, click **Restore**. "rom-0" is the name of the configuration file on the switch, so your backup configuration file is automatically renamed when you restore using this screen.

20.4 Backing Up a Configuration File

Backing up your switch configurations allows you to create various “snap shots” of your device from which you may restore at a later date.

Back up your current switch configuration to a computer using the **Configuration Backup** screen.

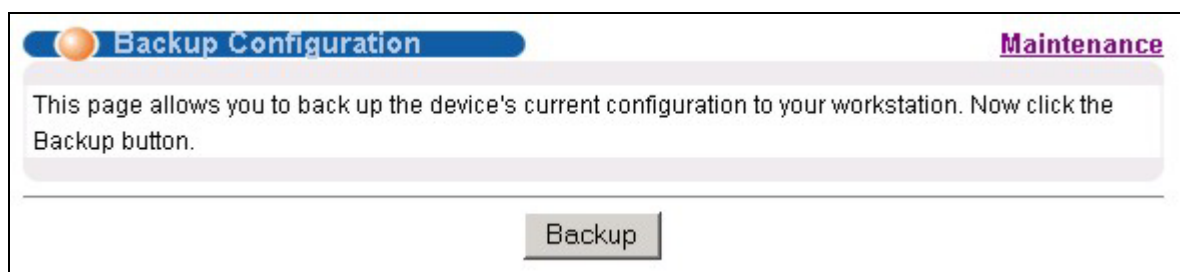

The screenshot shows a web interface for backing up a configuration. At the top, there is a blue header with an orange circle icon, the text "Backup Configuration", and a purple "Maintenance" link. Below the header, a light gray box contains the instruction: "This page allows you to back up the device's current configuration to your workstation. Now click the Backup button." At the bottom center of the interface is a "Backup" button.

Figure 20-4 Backup Configuration

Follow the steps below to back up the current switch configuration to your computer in this screen.

Step 1. Click **Backup**.

Step 2. Click **Save** to display the **Save As** screen.

Step 3. Choose a location to save the file on your computer from the **Save in** drop-down list box and type a descriptive name for it in the **File name** list box. Click **Save** to save the configuration file to your computer.

20.5 Load Factory Defaults

Press the **Click Here** button next to **Load Factory Defaults** to clear all switch configuration information you configured and return to the factory defaults. The following message appears.

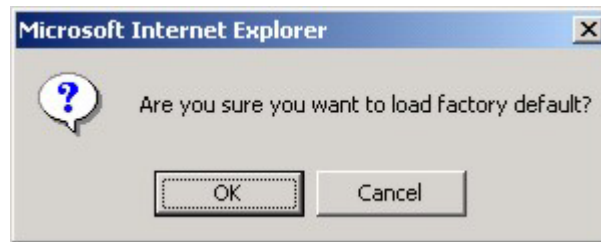

Figure 20-5 Confirm Load factory Defaults

Click **OK** to go to the next screen.

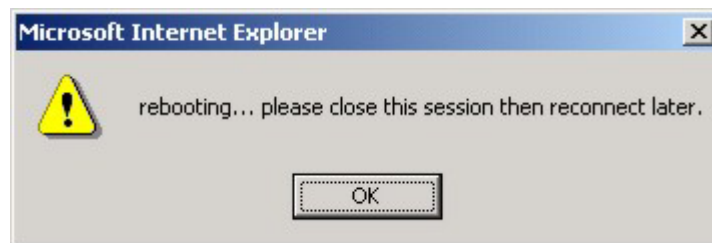

Figure 20-6 Restart Switch After Load Factory Defaults

Click **OK** to begin resetting all switch configurations to the factory defaults and then wait for the switch to restart. This takes up to two minutes. If you want to access the switch web configurator again, you may need to change the IP address of your computer to be in the same subnet as that of the default switch IP address (192.168.1.1).

20.6 Reboot System

Reboot System allows you to restart the switch without physically turning the power off. Press the **Click Here** button next to **Reboot System** to display the next screen.



Figure 20-7 Confirm Restart The Switch

Click **OK** in the screen that asks if you are sure you want to reboot the system. You then see the screen as shown in *Figure 20-6*. Click **OK** again and then wait for the switch to restart. This takes up to two minutes. This does not affect the switch's configuration.

20.7 Command Line FTP

This section shows some examples of uploading to or downloading files from the switch using FTP commands. First, understand the filename conventions.

20.7.1 Filename Conventions

The configuration file (often called the romfile or rom-0) contains the factory default settings in the screens such as password, switch setup, IP Setup, etc. It arrives from ZyXEL with a "rom" filename extension. Once you have customized the switch's settings, they can be saved back to your computer under a filename of your choosing.

ZyNOS (ZyXEL Network Operating System sometimes referred to as the "ras" file) is the system firmware and has a "bin" filename extension.

Table 20-1 Filename Conventions

FILE TYPE	INTERNAL NAME	EXTERNAL NAME	DESCRIPTION
Configuration File	Rom-0	*.rom	This is the configuration filename on the switch. Uploading the rom-0 file replaces the entire ROM file system, including your switch configurations, system-related data (including the default password), the error log and the trace log.
Firmware	Ras	*.bin	This is the generic name for the ZyNOS firmware on the switch.

Example FTP Commands

```
ftp> put firmware.bin ras
```

This is a sample FTP session showing the transfer of the computer file " firmware.bin" to the switch .

```
ftp> get rom-0 config.cfg
```

This is a sample FTP session saving the current configuration to a file called "config.cfg" on your computer.

If your (T)FTP client does not allow you to have a destination filename different than the source, you will need to rename them as the switch only recognizes "rom-0" and "ras". Be sure you keep unaltered copies of both files for later use.

Be sure to upload the correct model firmware as uploading the wrong model firmware may damage your device.

20.7.2 FTP Command Line Procedure

Step 1. Launch the FTP client on your computer.

Step 2. Enter “open”, followed by a space and the IP address of your switch.

Step 3. Press [ENTER] when prompted for a username.

Step 4. Enter your password as requested (the default is “1234”).

Step 5. Enter “bin” to set transfer mode to binary.

Step 6. Use “put” to transfer files from the computer to the switch, for example, “put firmware.bin ras” transfers the firmware on your computer (firmware.bin) to the switch and renames it “ras”. Similarly, “put config.rom rom-0” transfers the configuration file on your computer (config.rom) to the switch and renames it “rom-0”. Likewise “get rom-0 config.rom” transfers the configuration file on the switch to your computer and renames it “config.rom.” See earlier in this chapter for more information on filename conventions.

Step 7. Enter “quit” to exit the ftp prompt.

20.7.3 GUI-based FTP Clients

The following table describes some of the commands that you may see in GUI-based FTP clients.

Table 20-2 General Commands for GUI-based FTP Clients

COMMAND	DESCRIPTION
Host Address	Enter the address of the host server.
Login Type	Anonymous. This is when a user I.D. and password is automatically supplied to the server for anonymous access. Anonymous logins will work only if your ISP or service administrator has enabled this option. Normal. The server requires a unique User ID and Password to login.
Transfer Type	Transfer files in either ASCII (plain text format) or in binary mode. Configuration and firmware files should be transferred in binary mode.
Initial Remote Directory	Specify the default remote directory (path).
Initial Local Directory	Specify the default local directory (path).

20.7.4 FTP over WAN Restrictions

FTP over WAN will not work when:

- Telnet service is disabled in **Secured Client Sets**.
- The IP address(es) in the **Secured Client Sets** menu does not match the client IP address. If it does not match, the switch will disconnect the Telnet session immediately.

Chapter 21

Diagnostic

This chapter explains the Diagnostic screens.

21.1 Diagnostic

Click **Management** and then **Diagnostic** in the navigation panel to display this screen. Use this screen to check system logs, reset the system or ping IP addresses.

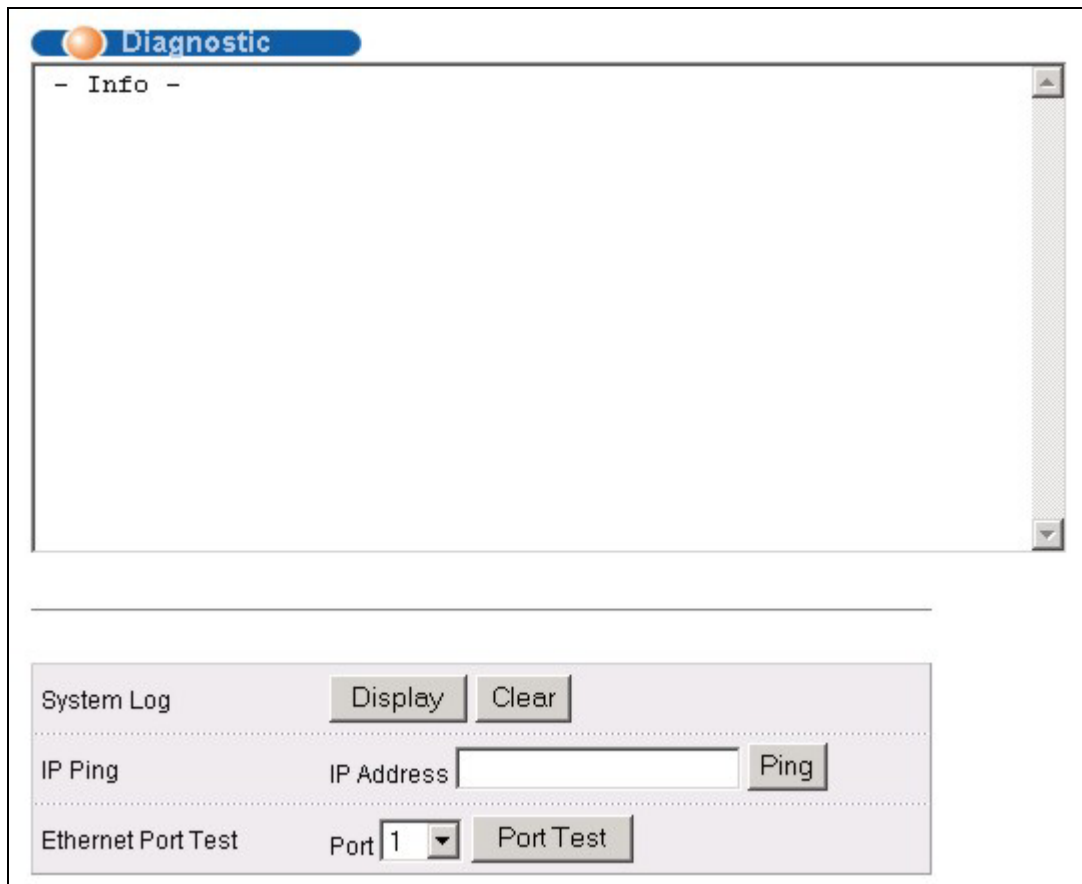

Figure 21-1 Diagnostic

The following table describes the labels in this screen.

Table 21-1 Diagnostic

LABEL	DESCRIPTION
System Log	Click Display to display a log of events in the multi-line text box. Click Clear to empty the text box and reset the syslog entry.

Table 21-1 Diagnostic

LABEL	DESCRIPTION
IP Ping	Type the IP address of a device that you want to ping in order to test a connection. Click Ping to have the switch ping the IP address (in the field to the left) 5 times
Ethernet Port Test	From the Port drop-down list box, select a port number and click Port Test to perform internal loopback test.

Chapter 22

Cluster Management

This chapter introduces cluster management.

22.1 Introduction to Cluster Management

Cluster management¹ allows you to manage switches through one switch, called the cluster manager. The switches must be directly connected and be in the same VLAN group so as to be able to communicate with one another.

Table 22-1 ZyXEL Clustering Management Specifications

Maximum number of cluster members	24
Cluster Member Models	Must be compatible with ZyXEL cluster management implementation.
Cluster Manager	The switch through which you manage the cluster member switches.
Cluster Members	The switches being managed by the cluster manager switch.

In the following example, switch A in the basement is the cluster manager and the other switches on the upper floors of the building are cluster members.

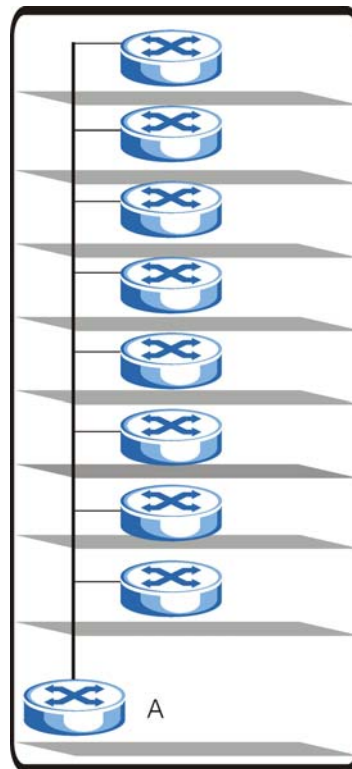

Figure 22-1 Clustering Application Example

¹ Cluster management may also be referred to as “iStacking” in other ZyXEL documentation.

22.2 Cluster Management Status

Click **Management** in the navigation panel and then **Cluster Management** to display the following screen.

Figure 22-2 Cluster Management Status

The following table describes the labels in this screen.

Table 22-2 Cluster Management Status

LABEL	DESCRIPTION
A cluster can only have one manager.	
Status	This field displays the role of this switch within the cluster. <ul style="list-style-type: none"> o Manager o Member (you see this if you access this screen in the cluster member switch directly and not via the cluster manager) o None (neither a manager nor a member of a cluster)
Manager	This field displays the cluster manager switch's hardware MAC Address.
The Number of Member	This field displays the number of switches that make up this cluster. The following fields describe the cluster member switches.
Index	You can manage cluster member switches via the cluster manager switch. Each number in the Index column is a hyperlink leading to the cluster member switch's web configurator (see <i>Figure 22-3</i>).
MacAddr	This is the cluster member switch's hardware MAC Address.
Name	This is the cluster member switch's System Name .
Model	This field displays the model name.

Table 22-2 Cluster Management Status

LABEL	DESCRIPTION
Status	This field displays: <ul style="list-style-type: none"> o Online (the cluster member switch is accessible) o Error (for example the cluster member switch password was changed or the switch was set as the manager and so left the member list, etc.) o Offline (the switch is disconnected - Offline shows approximately 1.5 minutes after the link between cluster member and manager goes down).

22.2.1 Cluster Member Switch Management

Go to the **Clustering Management Status** screen of the cluster manager switch and then select an **Index** hyperlink from the list of members to go to that cluster member switch's web configurator home page. This cluster member web configurator home page and the home page that you'd see if you accessed it directly are different (see *Figure 22-3*).

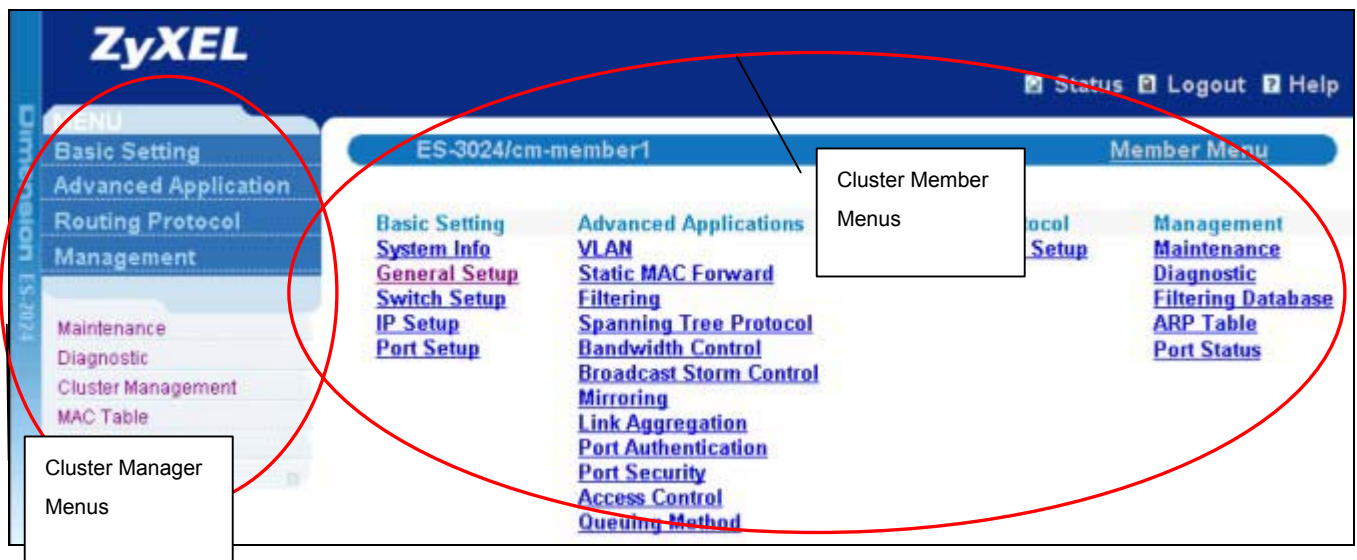

Figure 22-3 Cluster Member Web Configuration Screen Example

Uploading Firmware to a Cluster Member Switch

You can use FTP to upload firmware to a cluster member switch through the cluster manager switch as shown in the following example.

```

C:\> ftp <Cluster Manager IP address>
User : <Enter>
Password: 1234 is the default password
230 Logged in
230 Logged in
ftp> ls
200 Port command okay
150 Opening data connection for LIST
--w--w--w-  1 owner   group      1399654 Jul 01 12:00 ras
-rw-rw-rw-  1 owner   group      262144 Jul 01 12:00 rom-0
--w--w--w-  1 owner   group           0 Jul 01 12:00 fw-00-a0-c5-05-02-34
-rw-rw-rw-  1 owner   group           0 Jul 01 12:00 config-00-a0-c5-05-02-34
226 File sent OK
ftp: 462 bytes received in 0.01Seconds 30.80Kbytes/sec.
ftp> put 350DT3b1.bin fw-00-a0-c5-05-02-34
ftp> bye

```

Figure 22-4 Example: Uploading Firmware to a Cluster Member Switch

The following table explains some of the FTP parameters.

Table 22-3 FTP Upload to Cluster member Example

FTP PARAMETER	DESCRIPTION
User name	Press <Enter>
Password	The web configurator password default is 1234.
ls	Enter this command to list the name of cluster member switch's firmware and configuration file.
350DT3b1.bin	The name of the firmware file you want to upload to the cluster member switch.
fw-00-a0-c5-05-02-34	The cluster member switch's firmware name as seen in the cluster manager switch.
config-00-a0-c5-05-02-34	The cluster member switch's configuration file name as seen in the cluster manager switch.

22.3 Configuring Cluster Management

Click **Configuration** from the **Cluster Management** screen to display the next screen.

Clustering Management Configuration
Status

Clustering Manager:

Active	<input checked="" type="checkbox"/>
Name	<input type="text" value="Manager"/>
VID	1

Clustering Candidate:

List	<input type="text" value="00:a0:c5:5e:df:f9/ES-4024/ES-4024"/>
Password	<input type="text"/>

Index	MacAddr	Name	Model	Remove
1	00:a0:c5:58:a7:f0	cm-member1	ES-3024	<input type="checkbox"/>

Figure 22-5 Configuring Cluster Management

Table 22-4 Configuring Cluster Management

LABEL	DESCRIPTION
Active	Select Active to have this switch become the cluster manager switch. A cluster can only have one manager. Other (directly connected) switches that are set to be cluster managers will not be visible in the Clustering Candidates list. If a switch that was previously a cluster member is later set to become a cluster manager, then its Status is displayed as Error in the Cluster Management Status screen and a warning icon () appears in the member summary list below.
Name	Type a name to identify the Clustering Manager . You may use up to 32 printable characters (no spaces are allowed).
VID	This is the Management VLAN ID and is only applicable if the switch is set to 802.1Q VLAN. All switches must be in the same management VLAN group to belong to the same cluster. Switches that are not in the same management VLAN group are not visible in the Clustering Candidates list. This field is ignored if the Clustering Manager is using Port-based VLAN.

Table 22-4 Configuring Cluster Management

LABEL	DESCRIPTION
Apply	Click Apply to save these changes to the switch.
Cancel	Click Cancel to begin configuring this part of the screen afresh.
Clustering Candidate	The following fields relate to the switches that are potential cluster members.
List	A list of suitable candidates found by auto-discovery is shown here. The switches must be directly connected. Directly connected switches that are set to be cluster managers will not be visible in the Clustering Candidate list. Switches that are not in the same management VLAN group will not be visible in the Clustering Candidate list.
Password	<p>Each cluster member's password is its web configurator password. Select a member in the Clustering Candidate list and then enter its web configurator password. If that switch administrator changes the web configurator password afterwards, then it cannot be managed from the Cluster Manager. Its Status is displayed as Error in the Cluster Management Status screen and a warning icon () appears in the member summary list below.</p> <p>If multiple devices have the same password then hold [SHIFT] and click those switches to select them. Then enter their common web configurator password.</p>
Apply	Click Apply to save these changes to the switch.
Cancel	Click Cancel to begin configuring this part of the screen afresh.
Refresh	Click Refresh to perform auto-discovery again to list potential cluster members.
The next summary table shows the devices selected for clustering.	
Index	This is the index number of a cluster member switch.
MacAddr	This is the cluster member switch's hardware MAC address.
Name	This is the cluster member switch's System Name .
Model	This is the cluster member switch's model name.
Remove	Select this checkbox and then click the Remove button to remove a cluster member switch from the cluster.
Cancel	Click Cancel to begin configuring this part of the screen afresh.

Chapter 23

MAC Table

This chapter introduces the MAC Table.

23.1 Introduction to MAC Table

The MAC table shows how frames are forwarded or filtered across the switch's ports. It shows what device MAC address, belonging to what VLAN group (if any) is forwarded to which port(s) and whether the MAC address is dynamic (learned by the switch) or static (manually entered in **Static MAC Forwarding**).

The switch uses the MAC table to determine how to forward frames. See the following figure.

1. The switch examines a received frame and learns the port on which this source MAC address came.
2. The switch checks to see if the frame's destination MAC address matches a source MAC address already learned in the MAC table.
 - If the switch has already learned the port for this MAC address, then it forwards the frame to that port.
 - If the switch has not already learned the port for this MAC address, then the frame is flooded to all ports. Too much port flooding leads to network congestion.
 - If the switch has already learned the port for this MAC address, but the destination port is the same as the port it came in on, then it filters the frame.

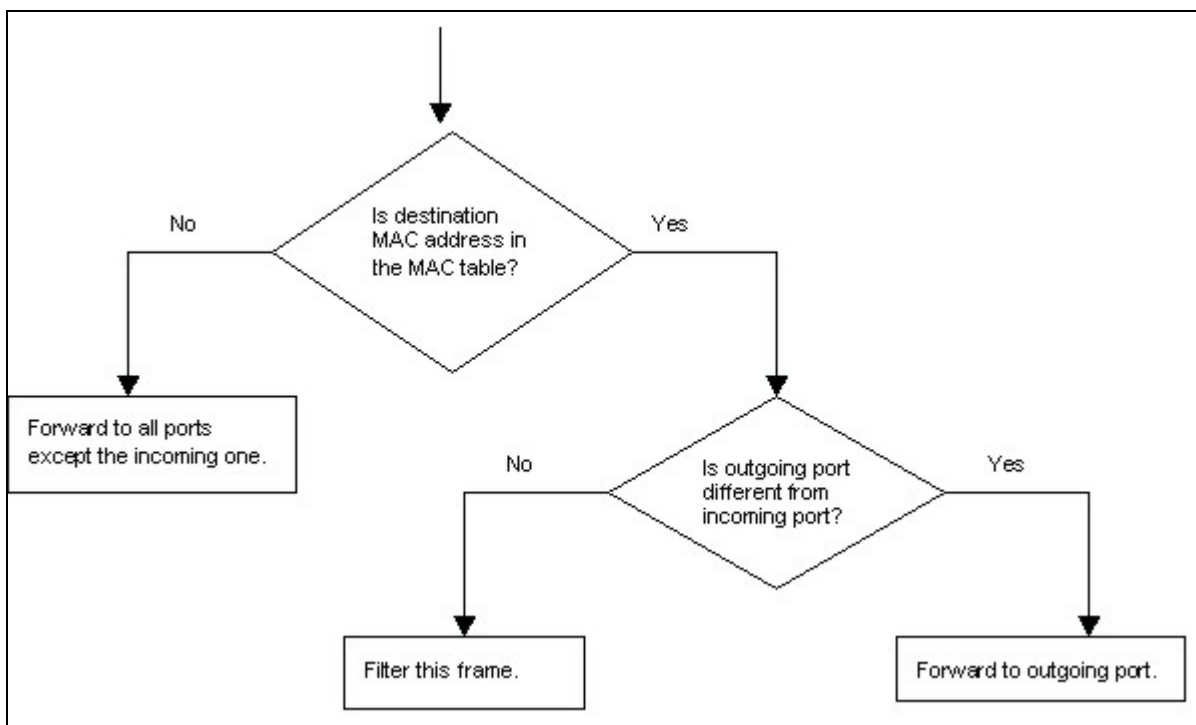

Figure 23-1 MAC Table Filtering Flowchart

23.2 Viewing MAC Table

Click **Management** in the navigation panel and then **MAC Table** to display the following screen. The MAC table can hold up to 10K entries.

Index	MAC Address	VID	Port	Type
1	00:00:e8:89:89:47	1	18	dynamic

Figure 23-2 MAC Table

The following table describes the labels in this screen.

Table 23-1 MAC Table

LABEL	DESCRIPTION
Sort by	Click one of the following buttons to display and arrange the data according to that button type. The information is then displayed in the summary table below.
MAC	Click this button to display and arrange the data according to MAC address.
VID	Click this button to display and arrange the data according to VLAN group.
Port	Click this button to display and arrange the data according to port number.
Index	This is the incoming frame index number.
MAC Address	This is the MAC address of the device from which this incoming frame came.
VID	This is the VLAN group to which this frame belongs.
Port	This is the port from which the above MAC address was learned.
Type	This shows whether the MAC address is dynamic (learned by the switch) or static (manually entered in Static MAC Forwarding).

Chapter 24

ARP Table

This chapter introduces ARP Table.

24.1 Introduction to ARP Table

Address Resolution Protocol (ARP) is a protocol for mapping an Internet Protocol address (IP address) to a physical machine address, also known as a Media Access Control or MAC address, on the local area network.

An IP (version 4) address is 32 bits long. In an Ethernet LAN, MAC addresses are 48 bits long. The ARP Table maintains an association between each MAC address and its corresponding IP address.

24.1.1 How ARP Works

When an incoming packet destined for a host device on a local area network arrives at the switch, the switch's ARP program looks in the ARP Table and, if it finds the address, sends it to the device.

If no entry is found for the IP address, ARP broadcasts the request to all the devices on the LAN. The switch fills in its own MAC and IP address in the sender address fields, and puts the known IP address of the target in the target IP address field. In addition, the switch puts all ones in the target MAC field (FF.FF.FF.FF.FF.FF is the Ethernet broadcast address). The replying device (which is either the IP address of the device being sought or the router that knows the way) replaces the broadcast address with the target's MAC address, swaps the sender and target pairs, and unicasts the answer directly back to the requesting machine. ARP updates the ARP Table for future reference and then sends the packet to the MAC address that replied.

24.2 Viewing ARP Table

Click **Management** in the navigation panel and then **ARP Table** to open the following screen. The ARP table can hold up to 500 entries.

ARP Table			
Index	IP Address	MAC Address	Type
1	127.0.0.101	00:a0:c5:32:71:95	dynamic
2	127.0.0.102	00:a0:c5:32:71:97	dynamic
3	127.0.0.103	00:a0:c5:61:28:92	dynamic
4	127.0.0.104	00:a0:c5:ff:12:6c	dynamic
5	127.0.0.105	00:a0:c5:4b:d6:67	dynamic
6	169.254.170.66	00:0b:cd:94:85:00	dynamic
7	172.17.2.1	00:60:b0:d6:e1:ad	dynamic
8	172.17.2.4	00:01:e6:61:26:d4	dynamic
9	172.17.2.6	00:10:83:95:30:a1	dynamic
10	172.17.2.254	00:01:30:b8:16:40	dynamic
11	172.21.0.2	00:05:5d:04:30:f1	dynamic
12	172.21.0.254	00:01:30:b8:16:40	dynamic
13	172.21.1.166	00:02:b3:2c:79:93	dynamic
14	172.21.2.229	00:50:8d:36:37:e2	dynamic
15	172.21.3.6	00:50:8d:36:3c:3b	dynamic
16	172.21.3.7	00:50:ba:ad:75:dd	dynamic
17	172.21.3.11	00:50:8d:af:13:31	dynamic
18	172.21.3.15	00:00:e8:89:88:06	dynamic
19	172.21.3.18	00:50:8d:af:2f:28	dynamic
20	172.21.3.19	00:a0:c5:01:23:46	dynamic
21	172.21.3.20	08:00:46:68:10:58	dynamic
22	172.21.3.21	00:0b:cd:94:89:32	dynamic
23	172.21.3.23	00:00:e2:93:68:06	dynamic
24	172.21.3.25	00:05:5d:e1:6c:cb	dynamic

Figure 24-1 ARP Table

The following table describes the labels in this screen.

Table 24-1 ARP Table

LABEL	DESCRIPTION
Index	This is the ARP Table entry number.
IP Address	This is the learned IP address of a device connected to a switch port with corresponding MAC address below.
MAC Address	This is the MAC address of the device with corresponding IP address above.
Type	This shows whether the MAC address is dynamic (learned by the switch) or static (manually entered in Static MAC Forwarding).

Part VII

Commands

This part gives information on Command Line Interface (CLI) commands for the ES-2024.

Chapter 25

Introduction to CLI

This chapter introduces line commands and gives a summary of commands available.

25.1 Command Line Interface Overview

In addition to the web configurator, you can use line commands to configure the switch. It is recommended that you use the web configurator for everyday management of the switch and that you use line commands for advanced switch diagnosis and troubleshooting. If you have problems with your switch, customer support may request that you issue some of these commands to assist them in troubleshooting.

You can use the “config save” command to save 802.1Q, STP, Cluster and IP configuration changes to non-volatile memory (Flash). These changes are effective after you restart the switch.

However you cannot use “config save” for all other line command configurations. These are saved in volatile memory (DRAM), so are not effective after you restart the switch.

25.1.1 Accessing the Command Line Interface

There are two ways to access the command line interface on the ES-2024:

- Telnet to the switch
- Connect a computer to the console port and use terminal emulation software configured to the following parameters:
 - VT100 terminal emulation
 - 9600 bps
 - No parity, 8 data bits, 1 stop bit
 - No flow control

25.1.2 Command Conventions

The system uses a one-level command structure. You must type the full command every time, as follows.

```
192.168.1.1> <command>
```

For instance, the following example shows how to enable GVRP.

```
192.168.1.1> sys sw gvrp enable
```

The conventions for typing in most CI commands are shown next.

```
command <interface|device> subcommand [parameter]
```

```
command subcommand [parameter]
```

Type all commands as displayed on the screen.

25.1.3 Command Syntax Conventions

1. Command keywords are in `courier new` font.
2. The `|` symbol means “or”.
3. Required fields in a command are enclosed in angle brackets `<>`. Use the following command to ping a host.

```
ip ping <hostid>
```

4. Optional fields in a command are enclosed in square brackets `[]`, for example, year, month and day are optional in the following command. This command just displays the date if you don't specify the year, month and day parameters.

```
sys date [year month day]
```

5. Commands can be abbreviated to the smallest unique string that differentiates the command. For example the “system date” command could be abbreviated to “s d”.

25.1.4 Getting Help

Type “help” or “?” to display a list of valid commands or type a command followed by “help” or “?” to display a list of associated subcommands.

The following figure shows a sample help information.

```
ES-2024> ?
Valid commands are:
sys                exit                ip

ES-2024> sys view ?
Usage: view <filename>
```

Figure 25-1 CLI Help: Sample Output

25.2 Command Summary

The following tables are summaries of the commands available in the ES-2024 together with a brief description of each command. See the related section in the *User's Guide* for more background information.

25.2.1 sys Commands

Table 25-1 Command Summary: sys

COMMAND		DESCRIPTION
sys		
	adjtime	Retrieves the date and time from the time server specified in the web configurator.

Table 25-1 Command Summary: sys

COMMAND		DESCRIPTION
countrycode	<country code>	Sets or displays the firmware country code.
cpu	display	Displays the CPU's utilization.
date	[year month day]	Sets or displays the system's current date.
domainname	[domain name]	Sets or displays the system domain name.
edit		Edits the system preset text file such as autoexec.net.
feature		Displays a list of the device's major features.
hostname	[hostname]	Sets or displays the system name.
log		
	clear	Clears the error log.
	disp	Shows the error log.
	online [on off]	Enables/disables the error log to be displayed on screen.
stdio	[minute]	Sets or displays the management terminal idle timeout value.
syslog	server	Set syslog server IP address
	facility	Set syslog facility
	type	Set/display syslog type flag
	mode	Set syslog mode
time	[hour [min [sec]]]	Sets or displays the system time.
trcdisp	parse, brief, disp	Sets the level of detail that should be displayed. Use "parse" to display the most detail and "disp" to display the least.
trclog		
	switch [on off]	Enables/disables/ the system trace log or shows whether it's on or off.
	online [on off]	Enables/disables the trace log onscreen display (for example in the telnet management window).
	level [level]	Sets the level (1-10) of trace logs (1 shows the least) to display.
	type <bitmap>	Uses hexadecimal characters to set the type of trace logs to record.
	disp	Shows the trace log.
	clear	Erases the trace log.

Table 25-1 Command Summary: sys

COMMAND		DESCRIPTION
	encapmask [mask]	Shows which type of encapsulation the trace log records or sets it if you specify the encapsulation's hexadecimal character.
trcpacket		
	create <entry> <size>	Creates a packet trace buffer.
	destroy	Removes the packet trace buffer.
	channel <name> [none incoming outgoing bothway]	Sets the packet trace direction for a given channel.
	string [on off]	Enables/disables the sending of a log to the trace packet buffer when configuration changes are made or displays the current setting.
	switch [on off]	Enables/disables packet trace or displays the current setting.
	disp	Displays the trace packets.
	udp	Sends the trace packets to another system using UDP.
	udp switch [on off]	Enables/disables the sending of the trace packets to another system using UDP or displays the current setting.
	udp addr <addr>	Sets the target IP address for sending trace packets using UDP.
	udp port <port>	Sets the UDP port (should match that of the target IP address) for sending trace packets using UDP.
	parse [[start_idx], end_idx]	Displays detailed packet details of the packet range specified.
	brief	Displays a brief listing of packet contents.
version		Displays the RAS code and driver versions.
view	view <filename>	Displays the specified text file.
wdog		
	switch [on off]	Turns the watchdog firmware protection feature on or off.
	cnt [value]	Sets (0-34463) or displays the current watchdog count (in 1.6 sec units).

Table 25-1 Command Summary: sys

COMMAND		DESCRIPTION
socket		Displays the system socket's ID #, type, control block address (PCB), IP address and port number of peer device connected to the socket (Remote Socket) and task control block (Owner).
snmp	getCommunity <index> [<community>]	Sets or displays the SNMP GetRequest community.
	setCommunity <index> [<community>]	Sets or displays the SNMP SetRequest community.
	trustedHost <index> [<host>]	Sets or displays the SNMP trusted host.
	trapCommunity <index> [<community>]	Sets or displays the SNMP Trap community.
	trapDest <index> [<destination>]	Sets or displays the SNMP trap server.
	disp <index all>	Shows SNMP settings.
cluster	active <name>	Assign a cluster name and enable clustering it.
	inactive <name>	Disable the cluster named.
	add <MAC addr> <password>	Add a member switch into the cluster using its web configurator password.
	remove <MAC addr>	Remove a member switch from the cluster.
	showMember	Shows details of member switches in this cluster.
	showCandidate	Shows a list of auto-discovered potential cluster members.
	status	Shows whether this switch is a cluster member, cluster manager or neither and information about members in the cluster.
	trace	Sets the cluster management debug level.
	telnet <host> [port]	Telnets to the specified host.
romreset		Sets the switch back to the factory default settings.
fanstatus		Displays the current operational state of the switch's fan.

25.2.2 sys sw Commands

The following commands are system switch commands; all are preceded with `sys sw`

Table 25-2 Command Summary: sys sw

COMMAND			DESCRIPTION
garp	status		Shows the GARP timer status.
	timer	<join timer(ms)><leave timer(ms)><leave all timer<ms>	Sets the GARP timer's Join Timer, Leave Timer and Leave All Timer.
gvrp	trace		Sets GVRP trace level.
	status		Shows the GVRP status.
	enable		Enables GVRP.
	disable		Disables GVRP.
pktcnt	<port 1-26>		Display port statistic counter.
pktcntclear	<port 1-26>		Reset port statistic counter.
port	<portID> <enable disable> <Speed> <FlowCtrl>		Port setup.
portstatus			Displays current port status and settings.
phyread	<portID> [<phyAddr>]		Reads PHY register.
phywrite	<portID> <phyAddr> <data>		Writes PHY register.
qos	defpri	<port> [<0:none 1:low 2:high>]	Sets the default ingress User Priority for a port.
	map	<0..7> [<0:low 1:high>]	Maps a User Priority to a Traffic Class.
	method	<0:FCFS 1:Strict 2:WRR [high weight] [low weight]>	Sets the QoS method.
	showmethod		Displays the QoS method.
vlan1q			All "sys sw vlan1q" commands relate to IEEE 802.1Q Tagged VLAN configuration. Use "config save" to save your configuration changes.
	port	status <port>	Shows a port's VLAN information.
		defaultVID <port><vid>	Sets the default VLAN ID of a port.
		accept <port> <all tagged untagged>	Sets the type of frames that a port accepts.
		gvrp <port> <enable disable>	Enables/disables GVRP on the specified port.
	svlan	cpu <vlan id>	Sets the VLAN ID of the management VLAN (CPU).
		setentry<name><vid><port><adctl> <tagctl>	Applies a static VLAN (name, admin control tag, tag control) to a port.

Table 25-2 Command Summary: sys sw

COMMAND			DESCRIPTION
		delentry <vid>	Deletes the specified (VID) static VLAN.
		active <vid>	Turns on the specified static VLAN.
		inactive <vid>	Turns off the specified static VLAN.
		list	Displays a table of static VLANs.
	vlan	list <all vid start_vid end_vid>	Shows the specified IEEE 802.1Q Tagged VLAN table.
	status		Shows the IEEE 802.1Q tagged status.
driver	config		Shows the switch's settings.
	count	disp	Shows the switch Network Driver Interface Specifications (NDIS) level counters (CPU interface).
		clear	Clears the switch NDIS level counters (CPU interface).
rstp			All "sys sw rstp" commands relate to rapid STP configuration. Refer to IEEE Std 802.1w. Use "config save" to save your configuration changes.
	bridge		
		enable	Enables RSTP.
		disable	Disables RSTP.
		priority <priority>	Sets the system priority.
		maxage <Max_Age>	Sets the max age timer
		hellotime <Hello_Time>	Sets the hello timer.
		forwardDelay <Forward_Delay_Time>	Sets the forward delay time
		version <STP:0 RSTP:2>	Displays/enables the STP mode; STP or RSTP. RSTP is the default used when configuring STP via web configurator.
	port		
		enable <port_no>	Enables RSTP on this port.
		disable <port_no>	Disables RSTP on this port.
		pathCost <Port_NO> <Cost 0:Auto>	Sets the specified port's path cost.
		priority <Port_NO> <Priority>	Sets the specified port's priority.
		edgeport <port_no>	Displays if this port is an edge port.

Table 25-2 Command Summary: sys sw

COMMAND			DESCRIPTION
		p2pLink <Port_NO> <Auto:2 True:1 False:0>	Sets whether the specified port can connect to one bridge or multiple bridges.
		mcheck <Port_NO>	Enables the Port Protocol Migration state machine (Disabled, Blocking, Listening, Learning, Forwarding) on the specified port.
	disp		Shows the RSTP runtime status.
	trace	[level]	Sets the RSTP debug level.
lacp			Refer to IEEE 802.3ad for more information on link aggregation control protocol (LACP). It is recommended that you use the web configurator to configure LACP parameters.
	agg		Displays aggregated ports.
	port		
		enable <port_no>	Enables LACP on the specified port.
		disable <port_no>	Disables LACP on the specified port.
		status <port_no>	Displays whether LACP is enabled on the specified port.
		actoradm activity [port_no] [0:passive 1:active]	Allows/disallows the specified local port to engage in link aggregation.
		actoradm display [port_no]	Shows whether the specified local port is engaged in link aggregation.
		actoradm key [port_no][key]	Shows the specified local port LACP key.
		actoradm priority [port_no] [priority]	Sets the specified local port LACP priority.
		actoradm timeout [port_no] [0:long_timeout 1:short_timeout]	Enables a short or long timeout on the specified local port.
	keymgnt	[on off]	Turns LACP key management on or off.
	syspriority	<priority>	Sets the LACP system priority. The switch with the lowest priority becomes the LACP "server".
	trace	[level]	Sets the LACP debug level.
dot1x			"sys sw dot1x" commands relate to IEEE 802.1X security.

Table 25-2 Command Summary: sys sw

COMMAND		DESCRIPTION	
	enable	Enables 802.1X security on the switch.	
	disable	Disables 802.1X security on the switch.	
	status	Shows switch 802.1X security status.	
	port		
		enable <port_no>	Enables 802.1X security on the specified port.
		disable <port_no>	Disables 802.1X security on the specified port.
		reauth <port_no> <on off>	Turns re-authentication on or off on the specified port.
		period <port_no><value>	Configures how often the specified port should be re-authenticated.
		status <port_no>	Displays 802.1X security status on the specified port.
	set		
		radius server <ip>	Sets the external RADIUS server IP address.
		radius secret <secret>	Sets the external RADIUS server password.
		radius port <port>	Sets the external RADIUS server port number.
		radius show	Displays the external RADIUS server settings.
bmstorm			These commands relate to broadcast storm control.
	enable		Turns on broadcast storm control.
	disable		Turns off broadcast storm control.
	disp		Displays broadcast storm control ports' settings.
	set	<threshold: 1(5%) 2(10%) 3(15%) 4(20%) 5(25%)>	Specifies the threshold percentage of broadcast frames that triggers broadcast storm control.
mac	static		Displays static MAC addresses.
		display [<mac> <vid>]	Displays current run-time static MAC addresses on the ports.
		set <port> <MAC> <vid>	Configures a static MAC address on the specified port.

Table 25-2 Command Summary: sys sw

COMMAND			DESCRIPTION
		del <port> <MAC> <vid>	Deletes a static MAC address on the specified port.
	ageSet	<timeout>	Sets aging timeout.
	ageView		Displays the aging timeout period.
	list	<all port_no>	Displays the forwarding table entries.
	flush	[port]	Flushes learned MAC addresses in the forwarding table.
	count	[port]	Displays the number of MAC addresses in the forwarding table.
	search	<MAC> <VID>	Searches the MAC/VID learned on which port.
mirror			The following commands relate to port mirrors. Port mirroring is copying traffic from one or all ports to another or all ports for external analysis.
	enable		Turns on port mirroring.
	disable		Turns off port mirroring.
	display		Displays current run-time port mirror settings.
	set	<none port_no...>	Sets the mirrored port (s) (the ports from which traffic is copied to another port for analysis).
	direction	<ingress egress both>	Sets the direction of mirrored traffic.
	port	<monitor port_no>	Sets the monitor port (the port to which traffic is copied for analysis).
bw			The following commands relate to defining a maximum allowable bandwidth for incoming and/or outgoing traffic flows for specified ports.
	display	<port>	Displays current run-time bandwidth control settings.
	set	<port> <enable disable> <ingress rate[kbps]> <egress rate[kbps]>	Enables or disables bandwidth control of ingress and/or egress rates on individual ports.

Table 25-2 Command Summary: sys sw

COMMAND			DESCRIPTION
trunk			The following commands relate to trunking. Trunking is the grouping of physical ports into one logical higher-capacity link.
	del	<id>	Delete a trunk group.
	display		Displays current run-time trunk settings.
	listView		Displays member list of trunk.
	set	<id> <port_no...>	Sets members of a trunk group.
mc			
	set	<addr> <port>...	Sets ports to a specific multicast address.
	del	<addr>	Deletes a specific multicast address.
	get	<addr>	Shows a multicast address's forwarding ports.
vlan			
	status		Displays VLAN status
	type	<802.1q port-based>	Sets VLAN mode

25.2.3 *exit Command*

Table 25-3 Command Summary: exit

COMMAND			DESCRIPTION
exit			Ends the console or telnet session.

25.2.4 *ip Commands*

Table 25-4 Command Summary: ip

COMMAND			DESCRIPTION
ip			
	address	[addr]	Displays the host IP address.
	alias	<iface>	Sets an alias for the specified interface.
	aliasdis	<0 1>	Disables/enables the alias for the specified interface.
	arp	status	Displays all interfaces' IP Address Resolution Protocol status.

Table 25-4 Command Summary: ip

COMMAND		DESCRIPTION
httpd	debug [on off]	Enables or disables the HTTP debug flag.
icmp		
	status	Displays the ICMP statistics counter.
	discovery <iface> [on off]	Sets the ICMP router discovery flag.
ifconfig	[iface] [ipaddr] [broadcast <addr> mtu <value> dynamic]	Configures a network interface.
ping	<hostid>	Pings a remote host.
route		
	status	Displays the routing table.
	add <dest addr>[/<bits>] <gateway> [<metric>]	Adds a route.
	addiface <dest addr>[/<bits>] <iface> [<metric>]	Adds an entry to the routing table for the specified interface.
	addprivate <dest addr>[/<bits>] <gateway> [<metric>]	Adds a private route.
	drop <host addr> [/<bits>]	Drops a route.
status		Displays IP statistic counters.
udp	status	Displays the UDP status.
tcp		
	status [tcb] [<interval>]	Displays the TCP statistic counters.
telnet	<host> [port]	Telnets to the specified host.
traceroute	<host> [ttl] [wait] [queries]	Sends ICMP packets to trace the route of a remote host.
igmpsnoop		
	status	Displays the IGMP group table.
	querier	Displays the port number of the incoming port that received the latest IGMP querier.
	enable	Turns on IGMP snooping.
	disable	Turns off IGMP snooping.
dhcp <iface>	mode <none client>	Set an interface to accept information from a DHCP server.
dhcp <iface>	status	Show whether an interface can accept information from a DHCP server.

Table 25-4 Command Summary: ip

COMMAND		DESCRIPTION
	dhcp <iface> client release	Release DHCP information such as the IP address from an interface
	dhcp <iface> client renew	Renew the IP address on the interface.
	dns	
	stats clear	Clears DNS statistics.
	stats disp	Displays DNS statistics.

25.2.5 *config Command*

Table 25-5 Command Summary: config

COMMAND		DESCRIPTION
config	save	<p>You can use the “config save” command to save 802.1Q, STP, Cluster and IP configuration changes to non-volatile memory (Flash). These changes are effective after you restart the switch.</p> <p>However you cannot use “config save” for all other line command configurations. These are saved in volatile memory (DRAM), so are not effective after you restart the switch.</p>

Chapter 26

Command Examples

This chapter describes some commands in more detail.

26.1 Commonly Used Commands Overview

These are commands that you may use frequently in configuring and maintaining your switch. See the following chapter for IEEE 802.1Q Tagged VLAN commands.

26.2 *sys* Commands

These are the commonly used commands that belong to the *sys* (system) group of commands.

26.2.1 *sys log disp*

Syntax:

```
sys log disp
```

This command displays the system error log. An example is shown next.

```
ras> sys log disp
 1 Wed Feb 12 15:27:45 2003 PP1d ERROR unknown variable
 6 Wed Feb 12 15:34:42 2003 PP13 INFO SMT Password pass
 9 Wed Feb 12 16:16:46 2003 PP13 INFO SMT Password pass
11 Wed Feb 12 16:26:06 2003 PP1d ERROR unknown variable
12 Wed Feb 12 16:31:18 2003 PP13 INFO SMT Password pass
14 Wed Feb 12 16:42:20 2003 PP13 INFO SMT Password pass
16 Wed Feb 12 16:55:39 2003 PP13 INFO SMT Password pass
18 Wed Feb 12 17:19:30 2003 PP13 INFO SMT Password pass
20 Wed Feb 12 17:43:31 2003 PP13 INFO SMT Password pass
22 Wed Feb 12 17:45:48 2003 PP1d ERROR unknown variable
23 Thu Feb 13 09:08:09 2003 PP14 ERROR Last errorlog repeat 54 Times
26 Thu Feb 13 09:23:53 2003 PP13 INFO SMT Password pass
28 Thu Feb 13 09:36:05 2003 PP13 INFO SMT Password pass
30 Thu Feb 13 09:52:48 2003 PP13 INFO SMT Password pass
34 Thu Feb 13 10:32:02 2003 PP13 INFO SMT Password pass
36 Thu Feb 13 11:51:02 2003 PP1f INFO adjtime task pause 1 day
37 Thu Feb 13 12:06:22 2003 PP13 INFO SMT Password pass
39 Thu Feb 13 12:15:12 2003 PP13 INFO SMT Password pass
42 Thu Feb 13 16:17:25 2003 PP13 INFO SMT Password pass
```

Figure 26-1 *sys log disp* Command Example

26.2.2 *sys log clear*

Syntax:

```
sys log clear
```

This command clears the system error log.

If you clear a log (using the `sys log clear` command), you cannot view it again.

26.2.3 *sys version*

Syntax:

```
sys version
```

This command shows the RAS code, firmware version, system uptime and bootbase version.

An example is shown next.

```
ES-2024> sys version
ZyNOS version: V3.50(LI.0) | 02/15/2004
romRasSize: 1032106
system up time: 0:08:57 (53618 ticks)
bootbase version: V1.00 | 11/20/2003
```

Figure 26-2 sys version Command Example

26.2.4 *sys sw vlan1q vlan list*

Syntax:

```
sys sw vlan1q vlan list <all|VID|start VID|end VID>
```

where

<all|VID|start VID|end VID>= Specify either all of the VLAN entries (all), a single VLAN ID (VID) or a range of VLAN IDs starting from a certain VID (start VID) or a range of VLAN IDs ending at a specific VID (end VID).

This command displays the IEEE 802.1Q tagged VLAN table. An example is shown next.

```
ES-2024> sys sw vlan1q vlan list all

  No.   VID  ElapsedTime  Status  EgressPort/UntaggedPort
  -----
  1)    1    0:39:52   Static  EEEEE | EEEEE | EEEEE | EEEEE | EEEEE | EEE
          UUUUU | UUUUU | UUUUU | UUUUU | UUUUU | UUU
```

Figure 26-3 sys sw vlan1q vlan list Command Example

26.2.5 *sys sw pktcnt*

Syntax:

```
sys sw pktcnt <port 1-26>
```

This command displays statistics of a port. An example is shown next.

```
ES-2024> sys sw pktcnt
Usage: pktcnt <port>
ES-2024> sys sw pktcnt 18
RxPkt64 = 87
RxPkt65to127 = 9
RxPkt128to255 = 2
RxPkt256to511 = 2
RxPkt512to1023 = 0
RxPkt1024toMax = 0
RxOverSizePkt = 0
RxUnderSizePkt = 0
RxFCSErr = 0
RxAlignErr = 0
RxJabber = 0
RxFragment = 0
TxUcastPkt = 0
TxNUcastPkt = 66
TxUnderrun = 0
TxExcesCollisn = 0
TxCollisn = 0
DropFwdLkup = 0
DropInOverrun = 0
```

Figure 26-4 sys sw pktcnt Command Example

26.2.6 *sys sw mac list*

Syntax:

```
sys sw mac list <all | port_no>
```

This command displays the MAC address(es) stored in the switch. An example is shown next.

```
ES-2024> sys sw mac list all

ADDR          MACADDR          FID  STA  IsTrkGrp  Port#  HiPriDmac  HiPriSmac
=====
=====
=====

Number of Static MACs: 0
Number of Dynamic MACs: 0
```

Figure 26-5 sys sw mac list Command Example

26.3 *sys cluster* Commands

These are the commonly used commands that belong to the “sys cluster” group of commands. Use “config save” to save these configurations.

26.3.1 *sys cluster status*

Syntax:

```
sys cluster status
```

This command shows whether this switch is a cluster member, cluster manager or neither and information about members in the cluster. An example is shown next.

```
ES-2024> sys cluster status
Cluster Info.
Status: 1 (0:none, 1:manager, 2:slave)
Name: Manager
number of members: 3,          member_p=3794a8
number of discover devices: 0, list_p=379ea8
```

Figure 26-6 sys cluster status Command Example

26.3.2 *sys cluster showMember*

Syntax:

```
sys cluster showMember
```

This command shows details of member switches in this cluster. An example is shown next.

```

ES-2024> sys cluster showMember
No1
  ipAddr = 127.0.0.1
  mask = 255.255.0.0
  hwAddr = 00:a0:c5:05:02:34
  hostName = ES-2024
  modelName=
  time = 100
  status = 4(0:Invalid, 1:waiting, 2:Active, 3:Inactive, 4:static)

No2
  ipAddr = 127.0.0.2
  mask = 255.255.0.0
  hwAddr = 00:a0:c5:05:22:11
  hostName = cm-member1
  modelName=ES-2024
  channel = swp05
  time = 90
  status = 2(0:Invalid, 1:waiting, 2:Active, 3:Inactive, 4:static)

No3
  ipAddr = 127.0.0.3
  mask = 255.255.0.0
  hwAddr = 00:a0:c5:3f:91:54
  hostName = ES-2024
  modelName=ES-2024
  channel = swp11
  time = 0
  status = 1(0:Invalid, 1:waiting, 2:Active, 3:Inactive, 4:static)

```

Figure 26-7 sys cluster showMember Command Example

26.3.3 *sys cluster showCandidate*

Syntax:

```
sys cluster showCandidate
```

This command shows a list of auto-discovered potential cluster members. An example is shown next.

```

ES-2024> sys cluster showCandidate
NO.1
  hwAddr = 00:a0:c5:e8:e5:e3
  hostName=
  modelName=VES-1000
  channel =
NO.2
  hwAddr = 00:a0:c5:77:77:77
  hostName=
  modelName=VES-1000
  channel =
ES-2024>

```

Figure 26-8 sys cluster status Command Example

26.4 *ip Commands*

These are the commonly used commands that belong to the ip group of commands. Use “config save” to save these configurations.

26.4.1 *ip ping*

Syntax:

```
ip ping <hostid>
```

This command pings a remote host. An example is shown next.

```
ES-2024> ip ping 192.168.1.10
Resolving 192.168.1.10... 192.168.1.10
   sent      rcvd  rate   rtt    avg    mdev    max    min
     1         1  100     0     0     0     0     0
     2         2  100     0     0     0     0     0
     3         3  100     0     0     0     0     0
```

Figure 26-9 IP PING Command Example

26.4.2 *ip route status*

Syntax:

```
ip route status
```

This command displays the routing table. An example is shown next.

```
ES-2024> ip route status

Dest          FF Len Device      Gateway      Metric stat Timer  Use
192.168.1.0   00 24 swp00       192.168.1.1    1   041b 0    3
default       00 0  swp00       192.168.1.254  2   001b 0  4205
```

Figure 26-10 ip route status Command Example

26.4.3 *ip arp status*

Syntax:

```
ip arp status
```

This command displays all interfaces' IP Address Resolution Protocol (ARP) status. An example is shown next.

```
ES-2024> ip arp status

received 1 badtype 0 bogus addr 0 reqst in 0 replies 1 reqst out 4 bad VID 0
cache hit 29 (0%), cache miss 8366 (99%)
IP-addr      Type      Time  Addr          stat iface channel
192.168.1.1  Ethernet  0     00:a0:c5:3f:91:56 43  NULL  NULL
num of arp entries= 1
```

Figure 26-11 ip arp status Command Example

26.4.4 *ip dhcp Command*

Syntax:

`ip dhcp swif0 mode none` (This command disables DHCP on the switch interface (swif0))

`ip dhcp swif0 status` (This command displays the DHCP status on the switch interface (swif0))

An example is shown next.

```
ES-2024> ip dhcp swif0 mode none
ES-2024> ip dhcp swif0 status
DHCP on iface swif0 is none
```

Figure 26-12 ip dhcp Command Examples

26.5 Enabling rstp on the Gigabit Ports

Step 1. First enable RSTP

```
sys sw rstp bridge enable
```

Step 2. Then enable RSTP on the gigabit ports.

```
sys sw rstp port enable 25
```

```
sys sw rstp port enable 26
```

Step 3. Save the configuration

```
config save
```

Chapter 27

IEEE 802.1Q Tagged VLAN Commands

This chapter describes the IEEE 802.1Q Tagged VLAN and associated commands. Use the “config save” command to save configuration changes.

27.1 IEEE 802.1Q Tagged VLAN Overview

See the *VLAN* chapter for more information on VLANs. There are two kinds of tagging:

1. Explicit Tagging

A VLAN identifier is added to the frame header that identifies the source VLAN.

2. Implicit Tagging

The MAC (Media Access Control) number, the port or other information is used to identify the source of a VLAN frame.

The IEEE 802.1Q Tagged VLAN uses both explicit and implicit tagging.

It is important for the switch to determine what devices are VLAN-aware and VLAN-unaware so that it can decide whether to forward a tagged frame (to a VLAN-aware device) or first strip the tag from a frame and then forward it (to a VLAN-unaware device).

27.2 Filtering Databases

A filtering database stores and organizes VLAN registration information useful for switching frames to and from a switch. A filtering database consists of a static entries (Static VLAN or SVLAN table) and dynamic entries (Dynamic VLAN or DVLAN table).

27.2.1 Static Entries (SVLAN Table)

Static entry registration information is added, modified and removed by administrators only.

27.2.2 Dynamic Entries (DVLAN Table)

Dynamic entries are learned by the switch and cannot be created or updated by administrators. The switch learns this information by observing what port, source address and VLAN ID (or VID) is associated with a frame. Entries are added and deleted using GARP VLAN Registration Protocol (GVRP), where GARP is the Generic Attribute Registration Protocol.

27.3 Configuring Tagged VLAN

The following procedure shows you how to configure tagged VLAN.

Step 1. Use the IEEE 802.1Q tagged VLAN commands to configure tagged VLAN for the switch.

- Use the `sys sw vlan1q svlan setentry` command to configure a VLAN ID for each port on the switch.
- Use the `sys sw vlan1q svlan active` command when you are finished configuring the VLAN (see the last step).
- Use the `sys sw vlan1q port defaultVID` command to set the VLAN ID you created for a port to that specific port in the PVID table.
- Use the `sys sw vlan1q svlan active` command to activate the VLAN IDs.

Example:

```
ES-2024> sys sw vlan1q svlan setentry up1 2000 24 fixed tag
for newly create VLAN, please use svlan active <VID> to activate this entry

ES-2024> sys sw vlan1q port defaultVID 24 2000

ES-2024> sys sw vlan1q svlan setentry up1 2001 25 fixed untag
for newly create VLAN, please use svlan active <VID> to activate this entry
ES-2024> sys sw vlan1q port defaultVID 25 2001

ES-2024> sys sw vlan1q svlan active 2000

ES-2024> sys sw vlan1q svlan active 2001
```

Figure 27-1 Tagged VLAN Configuration and Activation Example

Step 2. Configure your management VLAN.

- Use the `sys sw vlan1q svlan setentry` command to configure a VLAN ID (VID 3 in this example) for managing the switch (the “management” or “CPU” VLAN).
- Use the `sys sw vlan1q svlan active` command to activate the new management VLAN ID.

Example:

```
ES-2024> sys sw vlan1q svlan setentry example 3 24 fixed tag

ES-2024> sys sw vlan1q svlan active 3
```

Figure 27-2 CPU VLAN Configuration and Activation Example

Step 3. Perform the procedure below to complete the VLAN setup.

- a. Telnet to the operational IP address of the switch.
- b. Use the `sys sw vlan1q svlan cpu` command to set VID 3 as the management VLAN.
- c. Use the `sys sw svlan delentry` command to remove the default VLAN ID (1).

Example:

```
ES-2024> sys sw vlan1q svlan cpu 3
ES-2024> sys sw vlan1q svlan delentry 1
```

Figure 27-3 Deleting Default VLAN Example

27.4 IEEE VLAN1Q Tagged VLAN Configuration Commands

These *sw* (switch) commands allow you to configure and monitor the IEEE 802.1Q Tagged VLAN.

27.4.1 *garp status*

Syntax:

```
sys sw garp status
```

This command shows the switch's GARP timer settings, including the join, leave and leave all timers.

An example is shown next.

```
ES-2024> sys sw garp status

GARP Timer Status :
  Join Timer = 200 msec
  Leave Timer = 600 msec
  Leave All Timer = 10000 msec
ES-2024>
```

Figure 27-4 GARP STATUS Command Example

27.4.2 *garp timer*

Syntax:

```
sys sw garp timer <join timer(ms)> <leave timer(ms)> <leave all timer<ms>
```

where

<join timer (ms)>	=	This sets the duration of the Join Period timer for GVRP in milliseconds. Each port has a Join Period timer. The allowed Join Time range is between 100 and 32767 milliseconds; the default is 200 milliseconds.
<leave timer(ms)>	=	This sets the duration of the Leave Period timer for GVRP in milliseconds. Each port has a single Leave Period timer. Leave Time must be two times larger than Join Timer; the default is 600 milliseconds.
<leave all timer<ms>=>	=	This sets the duration of the Leave All Period timer for GVRP in milliseconds. Each port has a single Leave All Period timer. Leave All Timer must be larger than Leave Timer; the default is 10000 milliseconds.

This command sets the switch's GARP timer settings, including the join, leave and leave all timers.

Switches join VLANs by making a declaration. A declaration is made by issuing a Join message using GARP. Declarations are withdrawn by issuing a Leave message. A Leave All message terminates all registrations. GARP timers set declaration timeout values.

The following example sets the Join Timer to 300 milliseconds, the Leave Timer to 800 milliseconds and the Leave All Timer to 11000 milliseconds.

```
ES-2024> sys sw garp timer 300 800 11000
```

Figure 27-5 garp timer Command Example

27.4.3 *gvrp status*

Syntax:

```
sys sw gvrp status
```

This command shows the switch's GVRP settings.

An example is shown next.

```
ES-2024> sys sw gvrp status
GVRP control block status:
  gvrpEnable = 1
  gvrpPortEnable:
    00000000000000000000000000XXXX
```

Figure 27-6 garp status Command Example

27.4.4 *gvrp enable*

Syntax:

```
sys sw gvrp enable
```

This command turns on GVRP in order to propagate VLAN information beyond the switch.

27.4.5 *gvrp disable*

Syntax:

```
sys sw gvrp disable
```

This command turns off GVRP so that the switch does not propagate VLAN information to other switches.

27.4.6 *vlan1q port status*

Syntax:

```
sys sw vlan1q port status <port>
```

This command shows information about the specified port's VLAN settings.

The following example shows the settings for port 1.

```
ES-2024> sys sw vlan1q port status 1

Port 1 VLAN Setup :
Default VLAN ID = 1
VLAN Acceptable Type = All
GVRP = DISABLE
```

Figure 27-7 vlan1q port status Command Example

27.4.7 *vlan1q port default vid*

Syntax:

```
sys sw vlan1q port defaultVID <port> <VID>
```

where

<port> = A port number

<VID> = The VLAN ID. Valid parameter range = [1 – 255].

This command sets a default VLAN ID for all untagged packets that come in through the specified port.

The following example sets the default VID of port 1 to 200.

```
ES-2024> sys sw vlan1q port defaultVID 1 200
```

Figure 27-8 vlan1q port default vid Command Example

27.4.8 *vlan1q port accept*

Syntax:

```
sys sw vlan1q port accept <port> <all|tagged>
```

where

<port> = A port number

<all|tagged> = Specifies all Ethernet frames (tagged and untagged) or only tagged Ethernet frames.

This command sets the specified port to accept all Ethernet frames or only those with an IEEE 802.1Q VLAN tag.

The following example sets port 2 to accept only tagged frames.

```
ES-2024> sys sw vlan1q port accept 2 tagged
```

Figure 27-9 vlan1q port accept Command Example

27.4.9 *vlan1q port gvrp*

Syntax:

```
sys sw vlan1q port gvrp <port> <enable|disable>
```

where

<port> = A port number
<enable|disable> = Turn GVRP on or off.

This command turns GVRP on or off for the specified port.

The following example turns off GVRP for port 2.

```
ES-2024> sys sw vlan1q port gvrp 2 disable
```

Figure 27-10 vlan1q port gvrp Command Example

27.4.10 *vlan1q svlan cpu*

Syntax:

```
sys sw vlan1q svlan cpu <VLAN ID>
```

where

<VID> = The VLAN ID. Valid parameter range = [1 – 2048].

This command sets the management VLAN (CPU). You can only use ports that are members of this management VLAN in order to manage the switch.

The following example sets VLAN ID 2 to be the CPU (management) VLAN.

```
ES-2024> sys sw vlan1q svlan cpu 2
```

Figure 27-11 vlan1q svlan cpu Command Example

27.4.11 *vlan1q svlan setentry*

Syntax:

```
sys sw vlan1q svlan setentry <name> <VID> <port> <adctl> <tagctl>
```

where

<name> = A name to identify the SVLAN entry.

<VID> = The VLAN ID [1 – 2048].

<port> = This is the switch port number.

<adctl> = This is the registrar administration control flag.
Valid parameters = [fixed, forbidden, normal].
Enter *fixed* to register a <port #> to the static VLAN table with <vid>.
Enter *normal* to confirm registration of the <port #> to the static VLAN table with <vid>.
Enter *forbidden* to block a <port #> from joining the static VLAN table with <vid>.

<tagctl> = This is the tag control flag. Valid parameters = [tag|untag].
Enter *tag* to tag outgoing frames.
Enter *untag* to send outgoing frames without a tag.

This command adds or modifies an entry in the static VLAN table. Display your configuration by using the `sys sw vlan1q svlan list` command. An example of a configuration is shown next.

Modify a Static VLAN Table Example

The following is an example of how to modify a static VLAN table.

```
1.   ras> sys sw vlan1q svlan setentry 2000 1 fixed tag
2.   ras> sys sw vlan1q svlan setentry 2001 2 fixed tag
```

Figure 27-12 Modifying the Static VLAN Example

Forwarding Process Example

Tagged Frames

- Step 1.** First the switch checks the VLAN ID (VID) of tagged frames or assigns temporary VIDs to untagged frames (see *Section 27.4.7*).
- Step 2.** The switch then checks the VID in a frame's tag against the SVLAN table.
- Step 3.** The switch notes what the SVLAN table says (that is, the SVLAN tells the switch whether or not to forward a frame and if the forwarded frames should have tags).
- Step 4.** Then the switch applies the port filter to finish the forwarding decision. This means that frames may be dropped even if the SVLAN says to forward them. Frames might also be dropped if they are sent to a CPE (customer premises equipment) DSL device that does not accept tagged frames.

Untagged Frames

- Step 1.** An untagged frame comes in from the LAN.

- Step 2.** The switch checks the PVID table and assigns a temporary VID of 1.
- Step 3.** The switch ignores the port from which the frame came, because the switch does not send a frame to the port from which it came. The switch also does not forward frames to “forbidden” ports.
- Step 4.** If after looking at the SVLAN, the switch does not have any ports to which it will send the frame, it won’t check the port filter.

27.4.12 *vlan1q svlan delentry*

Syntax:

```
sys sw vlan1q svlan delentry <VID>
```

where

<VID> = The VLAN ID [1 – 2048].

This command deletes the specified VLAN ID entry from the static VLAN table

The following example deletes entry 2 in the static VLAN table.

```
ES-2024> sys sw vlan1q svlan delentry 2
```

Figure 27-13 vlan1q svlan delentry Command Example

27.5 *vlan1q svlan active*

Syntax:

```
sys sw vlan1q svlan active <VID>
```

This command enables the specified VLAN ID in the SVLAN (Static VLAN) table.

27.6 *vlan1q svlan inactive*

Syntax:

```
sys sw vlan1q svlan inactive <VID>
```

This command disables the specified VLAN ID in the SVLAN (Static VLAN) table.

27.7 *vlan1q svlan list*

Syntax:

```
sys sw vlan1q svlan list
```

This command shows the IEEE 802.1Q Tagged SVLAN (Static VLAN) table.

An example is shown next.

For the AdCt1 section of the last column, “-“ is a port set to normal, “x” is a forbidden port and “F” is a fixed port.

```
sys sw vlan1q vlan status
```

This command displays the current configuration of the IEEE 802.1Q VLAN.

See the following example shows the default VLAN settings. The default VLAN allows all ports to connect to each other and sets them to send untagged packets.

```
ES-2024> sys sw vlan1q status
802.1Q VLAN Setup :
  GVRP = Enable
  Managment VLAN ID = 1
```

Figure 27-16 vlan1q vlan status Command Example

Part VIII

Appendices and Index

This part contains appendices of advanced background feature information and an Index.

A Product Specifications

These are the ES-2024 product specifications.

Chart 1 General Product Specifications

Standards	<p>IEEE802.3 10BASE-T Ethernet (twisted-pair copper) IEEE802.3u 100BASE-TX Fast Ethernet (twisted-pair copper) ANSI/IEEE802.3 Auto-negotiation IEEE802.3x Flow Control IEEE802.1p Priority Queues IEEE802.1q VLAN IEEE802.1d Spanning Tree IEEE 802.1x Authentication IEEE 802.3ad Link Aggregation IEEE 802.1w Rapid Spanning Tree IEEE 802.3z Gigabit IEEE 802.3ab Gigabit</p>
Protocol	CSMA/CD
Interface	<p>24 10/100 Mbps Ethernet ports Two 100/1000 Mbps Ethernet ports Two mini GBIC slots for mini GBIC transceivers (SFP module) One console port</p>
Data Transfer Rate	<p>Ethernet: 10Mbps (half duplex), 20Mbps (full duplex) Fast Ethernet: 100Mbps (half duplex), 200Mbps(full duplex) Gigabit Ethernet: 2000Mbps (full duplex) Rates with mini GBIC transceivers depend on the transceiver used (see your transceiver's documentation)</p>
Network Cables	<p>10BASE-T: 2-pair Unshielded Twisted Pair (UTP) Cat.3, 4, 5 (100 meters) EIA/TIA-586 100-ohm Shielded Twisted Pair (STP) (100 meters) 100BASE-TX, 1000BASE-T: UTP Cat.5 (100 m max.) EIA/TIA-568 100-ohm STP (100 m max.) Cables for use with mini GBIC transceivers depend on the transceiver used (see your transceiver's documentation)</p>
Full/Half Duplex	<p>Full/half duplex for 10/100 Mbps speeds Full duplex only for gigabit speeds For the mini-GBIC modules, see your transceiver's documentation</p>
Media Interface Exchange	All ports are auto-crossover (auto-MDI-X) and auto-negotiating.

Chart 2 Performance and Management Specifications

Back plane	8.8 Gbps
Packet Forwarding Rate	14880 PPS for 10BASE-T 148800 PPS for 100BASE-TX/FX 1488000 PPS for 1000BASE-T Mini GBIC packet forwarding rate depends on the transceiver used (see your transceiver's documentation)
Switching Method	Store-and-forward
MAC Address Table	10 K entries
Data Buffer	3 Mb (excluding optional transceivers)
VLAN	IEEE 802.1Q tag-based VLAN, 2048 Max
Priority Queues	2 queues
Port Link Aggregation	IEEE802.3ad dynamic link aggregation
Port Security	MAC address learning enable /disable
Multicasting	Support IGMP snooping
Broadcast Storm	Support broadcast storm control
Port Mirroring	All Ethernet ports support port mirroring
Management	Web-based management Telnet SNMP Console
Management Security	User ID/Password for Telnet and Web-based management authentication Up to 4 administrators allowed
MIBs	SNMP MIB II (RFC 1213) RFC 1157 SNMP v1 RFC 1643 Ethernet MIBs RFC 1493 Bridge MIBs RFC 1155 SMI RFC 1757 RMON RFC 2674 SNMPv2, SNMPv2c

Chart 3 Physical and Environmental Specifications

Weight	Main switch: 2.9Kg
LED	For the whole switch: PWR, SYS, ALM Ethernet ports 1-24: LNK/ACT, FDX/COL Ports 25 and 26 (Ethernet RJ-45) 100/1000, ACT Ports 25 and 26 (Mini GBIC slots) LNK, ACT
Dimensions	441(W) x 226(D) x 66.5(H) mm (17.3(W) x 8.9(D) x 2.6(H) inches), 19-inch rack-mount width, 1.0 U height
Power Supply	100 - 240VAC 50/60Hz 0.55A max internal universal power supply
Power Consumption	Main switch: 21W maximum
Operating Temperature	0°C ~45°C (32°F to 113°F)
Storage Temperature	-25°C ~70°C
Operational Humidity	10% to 90% (Non-condensing)
Safety	North America UL 1950 listing CSA C22.2 No. 950 (Canada) European Union EN60950, EN41003
EMC	North America FCC Part15 (Class A)
EMI	European Union Conducted/Radiated Emission: EN55022 Class A
EMS	European Union
Current Harmonic	EN61000-3-2 +A12
Voltage Fluctuation	EN61000-3-3
Electrostatic Discharge (ESD)	IEC 1000-4-2, Level 2
Radiated Susceptibility	IEC 1000-4-3, Level 2
Electrical Fast Transients	IEC 1000-4-4, Level 2
Surge Test	IEC 1000-4-5

B *Index*

- 1
- 10/100M Auto-crossover Ethernet, 3-1
- 8
- 802.1Q VLAN Type, 6-6
- 802.3ad, 1-2
- A
- Acceptable Frame Type, 7-6
- Access Control, 17-1
- Aging Time, 6-6
- Airflow, 3-5
- All Connected, 7-13
- ALM, 3-5
- authenticationFailure, 17-3
- Auto-crossover, 3-2
- B
- Back plane, A-2
- Backup Configuration, 20-2
- Bandwidth Control, 1-2
- Bandwidth Control Setup, 10-1
- Basic Setting, 6-1
- Bridge ID, 9-3
- Bridge MIBs RFC 1493, 1-2
- Bridge Priority, 9-5
- Bridge Protocol Data Units (BPDUs), 9-1
- Broadcast storm control, 1-3
- Broadcast Storm Control, 12-1
- C
- Canonical Format Indicator, 7-1
- CE, iv
- Certification, iv
- CFI. See Canonical Format Indicator
- class A, iv
- CLI Command, 4-6, VII
 - Configure tagged VLAN example, 27-2
 - Getting help, 25-2
 - Static VLAN Table example, 27-7
 - sys Commands, 25-2
- Cold Start, 17-3
- Command
 - exit command, 25-11
 - ip commands, 25-11
 - Summary, 25-2
- Command
 - Command conventions, 25-1
 - config command, 25-13
 - Forwarding Process Example, 27-7
 - IEEE 802.1Q Tagged VLAN commands example, 27-1
 - Syntax conventions, 25-2
 - sys sw Commands, 25-5
- Command Line Interface, 4-6, VII
 - Accessing, 25-1
 - Introduction, 25-1
- config Command, 25-13
- config save, 3-6, 25-1, 25-6, 25-7, 25-13
- Configuring STP, 9-4
- Console Port, 1-1, 3-4
- Contact Person's Name, 6-3
- Contacting Customer Support, v
- Copyright, ii

Cost to Bridge, 9-4

Current Harmonic, A-3

Customer Support, v

D

Data Buffer, A-2

Daytime (RFC 867), 6-4

Default Settings

 Ethernet, 3-2

Diagnostic, 21-1

Dimensions, A-3

Disclaimer, ii

Domain Name Server, 6-8

Dropped Packet, 5-5

Duplex, 6-11

DVLAN Table, 27-1

Dynamic Link Aggregation, 14-1

E

egress port, 7-13

Electrical Fast Transients, A-3

EMC, A-3

EMI, A-3

EMS, A-3

Ethernet Address, 6-2

Ethernet MIBs RFC 1643, 1-2

Ethernet Port Test, 21-2

exit Command

 summary, 25-11

F

Fans, 1-2

FCC Rules, iv

FCC Warning, iv

Federal Communications Commission (FCC)
 Interference Statement, iv

File Transfer using FTP, 20-4

 command example, 20-4

 GUI-based, 20-5

 procedure, 20-4

 restrictions over WAN, 20-5

Filename Conventions, 20-4

Filtering Databases, 27-1

Firmware Upgrade, 20-1

Flow control, 3-6

Flow Control, 6-11

Forwarding Delay, 9-4, 9-6

Firmware version, 6-2

Front Panel, 3-1

Front Panel LEDs, 3-5

FTP, 20-4

G

GARP, 27-1. See Generic Attribute Registration
 Protocol

 garp status, 27-3

 GARP Status Command, 27-3

 GARP Terminology, 7-2

 garp timer, 27-3

 GARP Timer, 6-7

 General Setup, 6-1, 6-3

 Generic Attribute Registration Protocol, 7-2

 Get Community, 17-4

 GetNext, 17-3

 Giant, 5-5

 GVRP, 7-5, 27-1

 GVRP (GARP VLAN Registration Protocol), 7-2, 7-
 6

-
- gvrp disable, 27-4
 - gvrp enable, 27-4
 - gvrp status, 27-4
- H
- Hardware Monitor
 - Fans, 6-2
 - Hello Time, 9-3, 9-5
 - Help, 4-7
 - How STP Works, 9-1
 - HTML help, xvii
- I
- IEEE 802.1p, 6-7
 - IEEE 802.1Q. See Tagged VLAN
 - IEEE 802.1Q Tagged VLAN, 27-1
 - IEEE 802.1x, 15-1
 - IGMP snooping, 1-3
 - IGMP Snooping, 6-5
 - Ingress Check, 7-5
 - Ingress filtering, 7-2
 - Installation
 - Desktop, 2-1
 - Rack-Mounted, 2-1
 - IP Address, 6-8
 - ip arp status, 26-6
 - ip Commands
 - examples, 26-5
 - summary, 25-11
 - ip ping, 26-6
 - IP Protocols, 1-2
 - ip route status, 26-6
 - IP Setup, 6-1, 6-8
 - IP Subnet Mask, 6-8
- iStacking, 22-1
- J
- Join Timer, 6-7
- L
- LACP
 - Timeout, 14-5
 - LACP Status, 14-3
 - Leave All Timer, 6-7
 - Leave Timer, 6-7
 - LED Descriptions, 3-5
 - Link Aggregate Control Protocol (LACP), 14-1
 - Link Aggregation ID, 14-1
 - Link aggregation Setup, 14-4
 - Link Aggregation Setup, 14-4
 - linkDown, 17-3
 - Location, 6-3
 - Login Accounts, 17-4
- M
- MAC, 6-2
 - MAC address, 6-2
 - MAC address learning, 6-6, 8-1
 - MAC Address Learning, 6-6
 - MAC Address Table, A-2
 - Maintenance, 20-1
 - Management Information Base (MIB), 17-3
 - Management VLAN ID, 6-9
 - Max Age, 9-2, 9-3, 9-6
 - Media Access Control, 6-2
 - Media Interface Exchange, A-1
 - MIBs, A-2
 - Mirror port, 13-1
 - Mirror Setup, 13-2

Mounting Brackets, 2-2	Default for all ports, 7-1
Multi-tenant unit (MTU), xvii	Port-based VLANs, 7-10
N	Configure, 7-10
Navigation Panel Links, 4-3	Power Connector, 3-5
Network Applications	Power Consumption, A-3
Bridging, 1-4	Power Supply, A-3
Collapsed Backbone, 1-3	Priority, 6-7
High Performance Switched Workgroup, 1-5	Priority Level, 6-7
VLAN Application, 1-5	Priority Queue Assignment, 6-7, 6-11
VLAN Server, 1-6	Product specifications, A-1
VLAN Workgroup, 1-5	PWR, 3-5
Network Cables, A-1	Q
NTP (RFC-1305), 6-4	Quality of Service, 1-3
O	R
Operating Temperature, A-3	Radiated Susceptibility, A-3
Operational Humidity, A-3	RADIUS (Remote Authentication Dial-In User Service), 15-1
P	RADIUS Setup, 15-2
Packet Forwarding Rate, A-2	ras, 20-4
Password	Ras, 20-4
Default, 4-1	Rear Panel, 3-4
Path cost, 9-1	Rear Panel Connections
Ping, 21-2	Rear Panel, 3-5
POP (point-of-presence, xvii	Reauthentication, 15-4
Port Based VLAN Type, 6-6	Related Documentation, xvii
Port Details, 5-2, 5-3	Remote Management, 17-6
Port Isolation, 7-13	repair, iii
Port Mirroring, 1-2, 13-1, 25-10	Resetting the Switch, 4-6, 4-7
Port Setup, 6-9, 6-10	Restore Configuration, 20-2
Port Statistics. See Port Details	RMON RFC 1757, 1-2
Port Status, 5-1. See Port Details	Rom-0, 20-4
Port Link Aggregation, 1-2	Root bridge, 9-1
Port VID, 7-2	

-
- Rubber Feet, 2-1
 - Rx KB/s, 5-2, 5-4
 - Rx Packet, 5-4
 - RxPkts, 5-2, 5-4
 - S
 - Safety, A-3
 - Safety Warnings, 3-1
 - Scenarios, 2-1
 - Screen Overview, 4-4
 - Secured Client, 20-5
 - Server Port, 17-6
 - Service, iii
 - Service Access Control, 17-6
 - Set Community, 17-4
 - Shared Secret, 15-2
 - Simple Network Management Protocol, 17-2
 - SMI RFC 1155, 1-2
 - SNMP, 17-2
 - Configuring, 17-3
 - Trap, 17-4
 - Get, 17-3
 - Manager, 17-2
 - MIBs, 17-3
 - supported versions, 17-2
 - Trap, 17-3
 - SNMP Commands, 17-3
 - SNMP MIB II (RFC 1213), 1-2
 - SNMP Traps, 17-3
 - SNMP v1 RFC 1157, 1-2
 - SNMPv2, SNMPv2c RFC 2674, 1-2
 - Spanning Tree Protocol, 9-1
 - Stacking, 1-1
 - standard browser, 4-1
 - Standards, A-1
 - Static MAC Forward Setup, 8-1
 - Static MAC Forwarding, 8-1
 - Static Route
 - Setup, 19-1
 - Summary table, 19-2
 - Static VLAN, 7-6
 - Control, 7-8
 - Summary Table, 7-8
 - Tagging, 7-8
 - Status, 5-1
 - STP. See Spanning Tree Protocol
 - STP (Spanning Tree Protocol), 1-3
 - STP Path Costs, 9-1
 - STP Port States, 9-2
 - STP Status, 9-2
 - STP Terminology, 9-1
 - Surge Test, A-3
 - SVLAN Table, 27-1
 - Switch Lockout, 4-5
 - Switch Setup, 6-5, 7-3
 - Switching Method, A-2
 - Synchronized Ports, 14-3
 - Syntax Conventions, xvii
 - SYS, 3-5
 - sys Commands
 - examples, 26-1
 - Summary, 25-2
 - sys log clear, 26-1
 - sys log disp, 26-1
 - sys sw commands

summary, 25-6

sys sw mac list, 26-3

sys sw pktcnt, 26-2

sys sw vlan1q vlan list, 26-2

sys version, 26-2

System Information, 5-1, 6-1

System Log, 21-1

System Monitoring, 1-2

System Name, 6-3

System Priority, 14-5

System Statistics, 5-1

System up Time, 5-2

T

Tag Control Information, 7-1

Tag Protocol Identifier, 7-1

Tagged VLAN, 7-1

- GARP, 7-2
- GVRP, 7-2
- Membership Registration, 7-1

Taiwanese BSMI A Warning, iv

TCI. See Tag Control Information

Terminal emulation, 3-4

Terminal Emulation, 3-4, 25-1

Time (RFC-868), 6-4

Time server protocol supported, 6-4

TPID. See Tag Protocol Identifier

Trademarks, ii

Trap, 17-4

trusted computers, 17-7

TX Collision, 5-5

Tx KB/s, 5-2, 5-4

Tx Packet, 5-4

TxPkts, 5-2, 5-4

U

Up Time, 5-2

Mini GBIC Modules, 1-1

Username

- Default, 4-1

V

ventilation, 2-1

ventilation holes, 2-1

VID, 7-4, 7-6. See VLAN Identifier

VLAN, 7-1

- Explicit Tagging, 27-1
- Forwarding, 7-1
- ID (VID), 27-1
- Implicit Tagging, 27-1
- Introduction, 6-4
- Port-based, 7-10
- Priority frame, 7-1
- Registration Information, 27-1
- Tagged VLAN, 7-1

VLAN Administrative Control, 7-2

VLAN Group, 7-8

VLAN ID, 6-9, 7-1

- maximum number of, 7-1

VLAN Identifier, 7-1

VLAN Port Settings, 7-4

VLAN Status, 7-3

VLAN Tag Control, 7-2

VLAN Type, 6-6, 7-3

vlan1q port accept, 27-5

vlan1q port default vid, 27-5

vlan1q port gvrp, 27-6

