

# *P-2302HWUDL-P1 Series*

*802.11g Wireless VoIP Station Gateway  
with Built-in DECT Base Station*

## ***User's Guide***

Version 3.60  
10/2006  
Edition 1





# About This User's Guide

## Intended Audience

This manual is intended for people who want to configure the ZyXEL Device using the web configurator. You should have at least a basic knowledge of TCP/IP networking concepts and topology.

## Related Documentation

- Quick Start Guide  
The Quick Start Guide is designed to help you get up and running right away. It contains information on setting up your network and configuring for Internet access.
- Supporting Disk  
Refer to the included CD for support documents.
- ZyXEL Web Site  
Please refer to [www.zyxel.com](http://www.zyxel.com) for additional support documentation and product certifications.

## User Guide Feedback

Help us help you. Send all User Guide-related comments, questions or suggestions for improvement to the following address, or use e-mail instead. Thank you!

The Technical Writing Team,  
ZyXEL Communications Corp.,  
6 Innovation Road II,  
Science-Based Industrial Park,  
Hsinchu, 300, Taiwan.

E-mail: [techwriters@zyxel.com.tw](mailto:techwriters@zyxel.com.tw)

# Document Conventions

## Warnings and Notes

These are how warnings and notes are shown in this User's Guide.



---

**Warnings tell you about things that could harm you or your device.**

---



---

**Notes tell you other important information (for example, other things you may need to configure or helpful tips) or recommendations.**









---

## Syntax Conventions

- The P-2302HWUDL-P1 series may be referred to as the “ZyXEL Device”, the “device” or the “system” in this User's Guide.
- Product labels, screen names, field labels and field choices are all in **bold** font.
- A key stroke is denoted by square brackets and uppercase text, for example, [ENTER] means the “enter” or “return” key on your keyboard.
- “Enter” means for you to type one or more characters and then press the [ENTER] key. “Select” or “choose” means for you to use one of the predefined choices.
- A right angle bracket ( > ) within a screen name denotes a mouse click. For example, **Maintenance > Log > Log Setting** means you first click **Maintenance** in the navigation panel, then the **Log** sub menu and finally the **Log Setting** tab to get to that screen.
- Units of measurement may denote the “metric” value or the “scientific” value. For example, “k” for kilo may denote “1000” or “1024”, “M” for mega may denote “1000000” or “1048576” and so on.
- “e.g.” is a shorthand for “for instance”, and “i.e.” means “that is” or “in other words”.

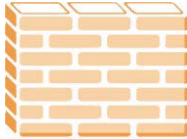
## Icons Used in Figures

Figures in this User's Guide may use the following generic icons. The ZyXEL Device icon is not an exact representation of your device.

ZyXEL Device 	Computer 	Notebook computer 
Server 	DSLAM 	Firewall 
Telephone 	Switch 	Router 

# Safety Warnings



---

**For your safety, be sure to read and follow all warning notices and instructions.**

---

- Do NOT use this product near water, for example, in a wet basement or near a swimming pool.
- Do NOT expose your device to dampness, dust or corrosive liquids.
- Do NOT store things on the device.
- Do NOT install, use, or service this device during a thunderstorm. There is a remote risk of electric shock from lightning.
- Connect ONLY suitable accessories to the device.
- Do NOT open the device or unit. Opening or removing covers can expose you to dangerous high voltage points or other risks. ONLY qualified service personnel should service or disassemble this device. Please contact your vendor for further information.
- Make sure to connect the cables to the correct ports.
- Place connecting cables carefully so that no one will step on them or stumble over them.
- Always disconnect all cables from this device before servicing or disassembling.
- Use ONLY an appropriate power adaptor or cord for your device.
- Connect the power adaptor or cord to the right supply voltage (for example, 110V AC in North America or 230V AC in Europe).
- Do NOT allow anything to rest on the power adaptor or cord and do NOT place the product where anyone can walk on the power adaptor or cord.
- Do NOT use the device if the power adaptor or cord is damaged as it might cause electrocution.
- If the power adaptor or cord is damaged, remove it from the power outlet.
- Do NOT attempt to repair the power adaptor or cord. Contact your local vendor to order a new one.
- Do not use the device outside, and make sure all the connections are indoors. There is a remote risk of electric shock from lightning.
- Do NOT obstruct the device ventilation slots, as insufficient airflow may harm your device.
- Use only No. 26 AWG (American Wire Gauge) or larger telecommunication line cord.
- Antenna Warning! This device meets ETSI and FCC certification requirements when using the included antenna(s). Only use the included antenna(s).

This product is recyclable. Dispose of it properly.

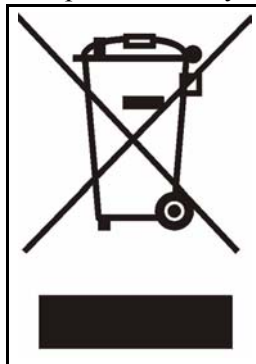





# Contents Overview

<b>Introduction, Wizards and Status .....</b>	<b>31</b>
Introducing the ZyXEL Device .....	33
Introducing the Web Configurator .....	39
Wizard Setup .....	47
Status Screens .....	67
<b>Network .....</b>	<b>77</b>
Wireless LAN .....	79
WAN .....	95
LAN .....	105
NAT .....	117
<b>VoIP .....</b>	<b>125</b>
SIP .....	127
Phone .....	141
Phone Book .....	155
PSTN Line .....	159
VoIP Trunking .....	161
<b>Security .....</b>	<b>177</b>
Firewall .....	179
Content Filter .....	187
<b>Management .....</b>	<b>191</b>
Static Route .....	193
Bandwidth MGMT .....	197
Remote MGMT .....	209
UPnP .....	217
Sharing a USB Printer .....	229
File Sharing .....	243
<b>Maintenance and Troubleshooting .....</b>	<b>251</b>
System .....	253
Logs .....	261
Tools .....	273
Troubleshooting .....	279

**Appendices and Index ..... 285**

# Table of Contents

<b>About This User's Guide .....</b>	<b>3</b>
<b>Document Conventions.....</b>	<b>4</b>
<b>Safety Warnings.....</b>	<b>6</b>
<b>Contents Overview .....</b>	<b>9</b>
<b>Table of Contents.....</b>	<b>11</b>
<b>List of Figures .....</b>	<b>21</b>
<b>List of Tables.....</b>	<b>27</b>
<b>Part I: Introduction, Wizards and Status .....</b>	<b>31</b>
<b>Chapter 1</b>	
<b>Introducing the ZyXEL Device .....</b>	<b>33</b>
1.1 Overview .....	33
1.1.1 VoIP Features .....	33
1.1.2 VoIP Trunking Gateway .....	34
1.1.3 DECT Base Station Feature .....	34
1.1.4 ZyXEL Device's USB Support .....	35
1.1.5 ZyXEL Device's Router Features .....	35
1.2 Ways to Manage the ZyXEL Device .....	36
1.3 Good Habits for Managing the ZyXEL Device .....	36
1.4 LEDs (Lights) .....	36
<b>Chapter 2</b>	
<b>Introducing the Web Configurator .....</b>	<b>39</b>
2.1 Web Configurator Overview .....	39
2.2 Accessing the Web Configurator .....	39
2.3 Resetting the ZyXEL Device .....	41
2.3.1 Reset Button and WLAN .....	42
2.4 Web Configurator Main Screen .....	42
2.4.1 Title Bar .....	43
2.4.2 Navigation Panel .....	43
2.4.3 Main Window .....	45
2.4.4 Status Bar .....	45

<b>Chapter 3</b>	
<b>Wizard Setup .....</b>	<b>47</b>
3.1 Main Wizard Screen .....	47
3.2 Connection Wizard .....	48
3.2.1 Welcome .....	49
3.2.2 System Information .....	49
3.2.3 ISP Parameters .....	50
3.2.4 Your IP Address .....	52
3.2.5 WAN IP Address Assignment .....	52
3.2.6 MAC Address .....	55
3.2.7 Finish .....	56
3.3 VoIP Setup Wizard .....	57
3.3.1 SIP Settings .....	57
3.3.2 Registration Complete .....	58
3.4 Bandwidth Management Wizard .....	60
3.4.1 Welcome .....	61
3.4.2 General Information .....	62
3.4.3 Services Setup .....	63
3.4.4 Priority Setup .....	64
3.4.5 Finish .....	65
<b>Chapter 4</b>	
<b>Status Screens .....</b>	<b>67</b>
4.1 Status Screen .....	67
4.2 Any IP Table Window .....	71
4.3 DHCP Table Window .....	71
4.4 VoIP Statistics Window .....	72
4.5 BW MGMT Monitor Window .....	73
4.6 Packet Statistics Window .....	75
<b>Part II: Network.....</b>	<b>77</b>
<b>Chapter 5</b>	
<b>Wireless LAN.....</b>	<b>79</b>
5.1 Wireless Network Overview .....	79
5.2 Wireless Security Overview .....	80
5.2.1 SSID .....	80
5.2.2 MAC Address Filter .....	80
5.2.3 User Authentication .....	80
5.2.4 Encryption .....	81
5.2.5 One-Touch Intelligent Security Technology (OTIST) .....	82

5.3 Additional Wireless Terms .....	82
5.4 General WLAN Screen .....	82
5.4.1 No Security .....	83
5.4.2 WEP Encryption Screen .....	84
5.4.3 WPA(2)-PSK .....	85
5.4.4 WPA(2) Authentication Screen .....	87
5.5 OTIST Screen .....	88
5.5.1 Notes on OTIST .....	90
5.6 MAC Filter .....	91
5.7 Wireless LAN Advanced Setup .....	93
<b>Chapter 6</b>	
<b>WAN.....</b>	<b>95</b>
6.1 WAN Overview .....	95
6.1.1 PPPoE Encapsulation .....	95
6.1.2 WAN IP Address Assignment .....	95
6.1.3 MAC Address .....	96
6.1.4 RIP Setup .....	96
6.1.5 DNS Server Address Assignment .....	96
6.2 WAN Screens .....	97
6.2.1 WAN Internet Connection Screen (Ethernet) .....	97
6.2.2 WAN Internet Connection Screen (Roadrunner) .....	98
6.2.3 WAN Internet Connection Screen (PPPoE) .....	99
6.2.4 WAN Advanced Screen .....	101
6.2.5 WAN Traffic Redirect Screen .....	103
<b>Chapter 7</b>	
<b>LAN.....</b>	<b>105</b>
7.1 LAN Overview .....	105
7.1.1 IP Address and Subnet Mask .....	105
7.1.2 DHCP Setup .....	106
7.1.3 LAN TCP/IP .....	106
7.1.4 DNS Server Address .....	106
7.1.5 RIP Setup .....	107
7.1.6 Multicast .....	107
7.1.7 Any IP .....	108
7.2 LAN Screens .....	109
7.2.1 LAN IP Screen .....	109
7.2.2 LAN DHCP Setup Screen .....	110
7.2.3 LAN Static DHCP Screen .....	111
7.2.4 LAN Client List Screen .....	112
7.2.5 LAN IP Alias Screen .....	113
7.2.6 LAN Advanced Screen .....	114

**Chapter 8**  
**NAT** ..... **117**

8.1 NAT Overview ..... 117  
     8.1.1 Port Forwarding: Services and Port Numbers ..... 117  
     8.1.2 Trigger Port Forwarding ..... 118  
     8.1.3 SIP ALG ..... 119  
   8.2 NAT Screens ..... 119  
     8.2.1 NAT General Screen ..... 119  
     8.2.2 NAT Port Forwarding Screen ..... 120  
     8.2.3 NAT Port Forwarding Edit Screen ..... 121  
     8.2.4 NAT Trigger Port Screen ..... 122  
     8.2.5 NAT ALG Screen ..... 123

**Part III: VoIP** ..... **125**

**Chapter 9**  
**SIP** ..... **127**

9.1 SIP Overview ..... 127  
     9.1.1 Introduction to VoIP ..... 127  
     9.1.2 Introduction to SIP ..... 127  
     9.1.3 SIP Identities ..... 127  
     9.1.4 SIP Call Progression ..... 128  
     9.1.5 SIP Client Server ..... 128  
     9.1.6 RTP ..... 130  
     9.1.7 NAT and SIP ..... 130  
     9.1.8 Voice Coding ..... 131  
     9.1.9 PSTN Call Setup Signaling ..... 132  
     9.1.10 MWI (Message Waiting Indication) ..... 132  
   9.2 Custom Tones (IVR) ..... 132  
     9.2.1 Quality of Service (QoS) ..... 133  
   9.3 SIP Screens ..... 134  
     9.3.1 SIP Settings Screen ..... 134  
     9.3.2 Advanced SIP Setup Screen ..... 135  
     9.3.3 SIP QoS Screen ..... 139

**Chapter 10**  
**Phone** ..... **141**

10.1 Analog Phone Overview ..... 141  
     10.1.1 Voice Activity Detection/Silence Suppression/Comfort Noise ..... 141  
     10.1.2 Echo Cancellation ..... 141  
     10.1.3 Supplementary Phone Services Overview ..... 141

10.2 Phone Screens .....	144
10.2.1 Analog Phone Screen .....	144
10.2.2 Advanced Analog Phone Setup Screen .....	145
10.3 DECT Base Station Overview .....	147
10.3.1 DECT Phone Registration .....	147
10.3.2 Using your DECT Phone .....	149
10.3.3 DECT Phone Screen .....	150
10.3.4 Common Phone Settings Screen .....	152
10.3.5 Phone Region Screen .....	152
<b>Chapter 11</b>	
<b>Phone Book .....</b>	<b>155</b>
11.1 Phone Book Screens .....	155
11.1.1 Incoming Call Policy Screen .....	155
11.1.2 Speed Dial Screen .....	157
<b>Chapter 12</b>	
<b>PSTN Line .....</b>	<b>159</b>
12.1 PSTN Line Overview .....	159
12.2 PSTN Line Screen .....	159
<b>Chapter 13</b>	
<b>VoIP Trunking .....</b>	<b>161</b>
13.1 VoIP Trunking Overview .....	161
13.2 VoIP Trunking and Security .....	161
13.2.1 Auto Attendant and Authentication .....	161
13.2.2 Peer Call Authentication .....	162
13.3 Call Rules .....	163
13.4 VoIP Trunking Scenarios .....	163
13.4.1 VoIP Phone To PSTN Phone .....	163
13.4.2 PSTN Phone To VoIP Phone .....	163
13.4.3 PSTN Phone To PSTN Phone via VoIP .....	164
13.5 Trunking General Screen .....	164
13.6 Trunking Peer Call Screen .....	165
13.7 Trunking Call Rule Screen .....	167
13.8 VoIP Trunking Example: VoIP to PSTN .....	169
13.8.1 Background Information .....	169
13.8.2 Configuration Details: Outgoing .....	169
13.8.3 Configuration Details: Incoming .....	170
13.8.4 Call Progression .....	171
13.9 VoIP Trunking Example: PSTN to PSTN via VoIP .....	171
13.9.1 Background Information .....	172
13.9.2 Configuration Details: Outgoing .....	172

13.9.3 Configuration Details: Incoming .....	174
13.9.4 Call Progression .....	175
<b>Part IV: Security .....</b>	<b>177</b>
<b>Chapter 14</b>	
<b>Firewall.....</b>	<b>179</b>
14.1 Firewall Overview .....	179
14.1.1 Stateful Inspection Firewall. ....	179
14.1.2 About the ZyXEL Device Firewall .....	179
14.1.3 Guidelines For Enhancing Security With Your Firewall .....	180
14.1.4 The Firewall, NAT and Remote Management .....	180
14.2 Triangle Route .....	181
14.2.1 The “Triangle Route” Problem .....	181
14.2.2 Solving the “Triangle Route” Problem .....	182
14.3 Firewall Screens .....	183
14.3.1 General Firewall Screen .....	183
14.3.2 Firewall Services Screen .....	184
<b>Chapter 15</b>	
<b>Content Filter.....</b>	<b>187</b>
15.1 Content Filtering Overview .....	187
15.2 Content Filtering Screens .....	187
15.2.1 Content Filter Screen .....	187
15.2.2 Content Filter Schedule Screen .....	189
<b>Part V: Management.....</b>	<b>191</b>
<b>Chapter 16</b>	
<b>Static Route .....</b>	<b>193</b>
16.1 Static Route Overview .....	193
16.2 Static Route Screens .....	193
16.2.1 IP Static Route Screen .....	193
16.2.2 IP Static Route Edit Screen .....	194
<b>Chapter 17</b>	
<b>Bandwidth MGMT.....</b>	<b>197</b>
17.1 Bandwidth Management Overview .....	197
17.1.1 Bandwidth Classes and Filters .....	197
17.1.2 Proportional Bandwidth Allocation .....	198



17.1.3 Application-based Bandwidth Management .....	198
17.1.4 Subnet-based Bandwidth Management .....	198
17.1.5 Application- and Subnet-based Bandwidth Management .....	198
17.1.6 Scheduler .....	198
17.1.7 Maximize Bandwidth Usage .....	199
17.1.8 Bandwidth Borrowing .....	201
17.1.9 Over Allotment of Bandwidth .....	202
17.2 Bandwidth Management Screens .....	202
17.2.1 Bandwidth Management Summary Screen .....	202
17.2.2 Bandwidth Class Setup Screen .....	205
17.2.3 Bandwidth Class Edit Screen .....	206
17.2.4 Bandwidth Monitor Screen .....	207
<b>Chapter 18</b>	
<b>Remote MGMT .....</b>	<b>209</b>
18.1 Remote Management Overview .....	209
18.1.1 Remote Management Limitations .....	209
18.1.2 Remote Management and NAT .....	209
18.1.3 System Timeout .....	210
18.2 Remote Management Screens .....	210
18.2.1 WWW Screen .....	210
18.2.2 Telnet Screen .....	210
18.2.3 FTP Screen .....	211
18.3 SNMP .....	212
18.3.1 Supported MIBs .....	213
18.3.2 SNMP Traps .....	213
18.3.3 Configuring SNMP .....	213
18.3.4 DNS Screen .....	214
18.3.5 Security Screen .....	215
<b>Chapter 19</b>	
<b>UPnP .....</b>	<b>217</b>
19.1 Introducing Universal Plug and Play .....	217
19.1.1 How do I know if I'm using UPnP? .....	217
19.1.2 NAT Traversal .....	217
19.1.3 Cautions with UPnP .....	217
19.1.4 UPnP and ZyXEL .....	218
19.2 UPnP Examples .....	218
19.2.1 Installing UPnP in Windows Example .....	218
19.2.2 Using UPnP in Windows XP Example .....	221
19.3 UPnP Screen .....	227
<b>Chapter 20</b>	
<b>Sharing a USB Printer .....</b>	<b>229</b>

20.1 Overview .....	229
20.2 Requirements .....	229
20.3 Configure a TCP/IP Printer Port .....	230
20.4 Print Server Screen .....	234
20.5 Adding a New Printer Example .....	235
20.6 Macintosh OS X Adding Printer Example .....	240
<b>Chapter 21</b>	
<b>File Sharing .....</b>	<b>243</b>
21.1 File Sharing Implementation Overview .....	243
21.2 Sharing Files via the ZyXEL Device .....	244
21.2.1 Using the Workgroup Name to Share Files .....	244
21.3 User Accounts .....	245
21.4 File Sharing - General Screen .....	245
21.5 Accessing Files via the ZyXEL Device .....	247
21.5.1 Using Windows Explorer to Share Files .....	247
21.5.2 Using the Run Utility to Share Files .....	248
21.5.3 Using the Workgroup Name to Access Files .....	248
<b>Part VI: Maintenance and Troubleshooting .....</b>	<b>251</b>
<b>Chapter 22</b>	
<b>System .....</b>	<b>253</b>
22.1 System Overview .....	253
22.1.1 System Name .....	253
22.1.2 Domain Name .....	253
22.1.3 General System Screen .....	253
22.2 Dynamic DNS Overview .....	254
22.2.1 DNS Server Address Assignment .....	255
22.2.2 Dynamic DNS .....	255
22.2.3 Dynamic DNS Screen .....	255
22.3 Time Setting Overview .....	257
22.3.1 Pre-defined NTP Time Servers List .....	257
22.3.2 Resetting the Time .....	258
22.3.3 Time Settings Screen .....	258
<b>Chapter 23</b>	
<b>Logs .....</b>	<b>261</b>
23.1 Logs Overview .....	261
23.1.1 Alerts .....	261
23.1.2 Syslog Logs .....	261

23.2 Logs Screens .....	262
23.2.1 View Log Screen .....	262
23.2.2 Log Settings Screen .....	263
23.3 Log Message Descriptions .....	265
<b>Chapter 24</b>	
<b>Tools.....</b>	<b>273</b>
24.1 Tools Overview .....	273
24.1.1 ZyXEL Firmware .....	273
24.2 Tools Screens .....	273
24.2.1 Firmware Screen .....	273
24.2.2 Firmware Upload Screens .....	274
24.2.3 Configuration Screen .....	275
24.2.4 Restore Configuration Screens .....	276
24.2.5 Restart Screen .....	277
<b>Chapter 25</b>	
<b>Troubleshooting.....</b>	<b>279</b>
25.1 Power, Hardware Connections, and LEDs .....	279
25.2 ZyXEL Device Access and Login .....	280
25.3 Internet Access .....	281
25.4 Phone Calls and VoIP .....	282
25.5 Problems With Multiple SIP Accounts .....	282
25.5.1 Outgoing Calls .....	283
25.5.2 Incoming Calls .....	283
<b>Part VII: Appendices and Index .....</b>	<b>285</b>
Appendix A Product Specifications.....	287
Appendix B Pop-Up Windows, Java and JavaScript Permissions .....	293
25.6 Pop-up Windows, JavaScripts and Java Permissions .....	293
25.6.1 Internet Explorer Pop-up Blockers .....	293
25.6.2 JavaScripts .....	296
25.6.3 Java Permissions .....	297
Appendix C IP Addresses and Subnetting .....	299
Appendix D Setting up Your Computer's IP Address .....	307
Appendix E SIP Passthrough.....	321
Appendix F Internal SPTGEN.....	323

Appendix G Services .....	339
Appendix H Legal Information .....	343
Appendix I Customer Support .....	347
<b>Index.....</b>	<b>351</b>

# List of Figures

Figure 1 ZyXEL Device's VoIP Features .....	33
Figure 2 ZyXEL Device as a VoIP Trunking Gateway .....	34
Figure 3 DECT Base Station Feature .....	34
Figure 4 File Sharing Overview .....	35
Figure 5 ZyXEL Device's Router Features .....	35
Figure 6 LEDs .....	37
Figure 7 Login Screen .....	40
Figure 8 Change Password Screen .....	40
Figure 9 Select Mode Screen .....	41
Figure 10 Main Screen .....	42
Figure 11 Main Wizard Screen .....	47
Figure 12 Connection Wizard > Welcome .....	49
Figure 13 Connection Wizard > System Information .....	49
Figure 14 Connection Wizard > ISP Parameters (Ethernet) .....	50
Figure 15 Connection Wizard > ISP Parameters (PPPoE) .....	51
Figure 16 Connection Wizard > IP Address .....	52
Figure 17 Connection Wizard > IP Address (Ethernet) .....	53
Figure 18 Connection Wizard > IP Address (PPPoE) .....	54
Figure 19 Connection Wizard > MAC Address .....	55
Figure 20 Connection Wizard > Finish .....	56
Figure 21 VoIP Setup Wizard > SIP Settings .....	57
Figure 22 VoIP Setup Wizard > Registration Test .....	58
Figure 23 VoIP Setup Wizard > Registration Complete (Success) .....	59
Figure 24 VoIP Setup Wizard > Registration Complete (Fail) .....	60
Figure 25 Bandwidth Management Wizard > Welcome .....	61
Figure 26 Bandwidth Management Wizard > General Information .....	62
Figure 27 Bandwidth Management Wizard > Services Setup .....	63
Figure 28 Bandwidth Management Wizard > Priority Setup .....	64
Figure 29 Bandwidth Management Wizard > Finish .....	65
Figure 30 Status Screen .....	68
Figure 31 Any IP Table Window .....	71
Figure 32 DHCP Table Window .....	71
Figure 33 VoIP Statistics Window .....	72
Figure 34 BW MGMT Monitor Window .....	74
Figure 35 Packet Statistics Window .....	75
Figure 36 Example of a Wireless Network .....	79
Figure 37 Wireless LAN: General .....	83
Figure 38 Wireless: No Security .....	84

Figure 39 Wireless: Static WEP Encryption .....	85
Figure 40 Wireless: WPA(2)-PSK .....	86
Figure 41 Wireless: WPA(2) .....	87
Figure 42 Network > Wireless LAN > OTIST .....	88
Figure 43 Example: Wireless Client OTIST Screen .....	89
Figure 44 OTIST: Settings .....	90
Figure 45 OTIST: In Progress on the Wireless Device .....	90
Figure 46 Start OTIST? .....	91
Figure 47 MAC Address Filter .....	92
Figure 48 Wireless LAN: Advanced .....	93
Figure 49 Network > WAN > Internet Connection (Ethernet) .....	97
Figure 50 Network > WAN > Internet Connection (Roadrunner) .....	99
Figure 51 Network > WAN > Internet Connection (PPPoE) .....	100
Figure 52 Network > WAN > Advanced .....	102
Figure 53 Network > WAN > Traffic Redirect .....	103
Figure 54 Any IP Example .....	108
Figure 55 Network > LAN > IP .....	109
Figure 56 Network > LAN > DHCP Setup .....	110
Figure 57 Network > LAN > Static DHCP .....	111
Figure 58 Network > LAN > Client List .....	112
Figure 59 Network > LAN > IP Alias .....	113
Figure 60 Network > LAN > Advanced .....	114
Figure 61 Multiple Servers Behind NAT Example .....	118
Figure 62 Trigger Port Forwarding Process: Example .....	118
Figure 63 Network > NAT > General .....	119
Figure 64 Network > NAT > Port Forwarding .....	120
Figure 65 Network > NAT > Port Forwarding > Edit .....	121
Figure 66 Network > NAT > Trigger Port .....	122
Figure 67 Network > NAT > ALG .....	123
Figure 68 SIP User Agent .....	129
Figure 69 SIP Proxy Server .....	129
Figure 70 SIP Redirect Server .....	130
Figure 71 STUN .....	131
Figure 72 DiffServ: Differentiated Service Field .....	133
Figure 73 VoIP > SIP > SIP Settings .....	134
Figure 74 VoIP > SIP > SIP Settings > Advanced .....	136
Figure 75 VoIP > SIP > QoS .....	140
Figure 76 VoIP > Phone > Analog Phone .....	145
Figure 77 VoIP > Phone > Analog Phone > Advanced .....	146
Figure 78 DECT Base Station Overview .....	147
Figure 79 DECT Base Station Button - Top of the ZyXEL Device .....	148
Figure 80 DECT Base Station - Phone Registration .....	148
Figure 81 Using Your DECT Phone .....	149

Figure 82 VoIP > Phone > DECT Phone .....	151
Figure 83 VoIP > Phone > Common .....	152
Figure 84 VoIP > Phone > Region .....	152
Figure 85 VoIP > Phone Book > Incoming Call Policy .....	155
Figure 86 VoIP > PSTN Line > General .....	160
Figure 87 Peer Devices Connecting .....	162
Figure 88 VoIP Phone To PSTN Phone .....	163
Figure 89 PSTN Phone To VoIP Phone .....	164
Figure 90 PSTN Phone To PSTN Phone via VoIP .....	164
Figure 91 VoIP > Trunking > General .....	164
Figure 92 VoIP > Trunking > Peer Call .....	166
Figure 93 VoIP > Trunking > Call Rule .....	168
Figure 94 VoIP to PSTN Example .....	169
Figure 95 VoIP to PSTN Example - Speed Dial Screen .....	170
Figure 96 VoIP to PSTN Example - Outgoing Authentication .....	170
Figure 97 VoIP to PSTN Example - Incoming Authentication .....	171
Figure 98 PSTN to PSTN Example .....	172
Figure 99 PSTN to PSTN Example: General Configuration .....	173
Figure 100 PSTN to PSTN Example - Outgoing Authentication .....	173
Figure 101 PSTN to PSTN Example - Call Rule .....	174
Figure 102 PSTN to PSTN Example - Incoming Authentication .....	174
Figure 103 Firewall Rule Directions .....	180
Figure 104 Ideal Firewall Setup .....	181
Figure 105 "Triangle Route" Problem .....	182
Figure 106 IP Alias .....	183
Figure 107 Security > Firewall > General .....	183
Figure 108 Security > Firewall > Services .....	184
Figure 109 Security > Content Filter > Filter .....	188
Figure 110 Security > Content Filter > Schedule .....	189
Figure 111 Example of Static Routing Topology .....	193
Figure 112 Management > Static Route > IP Static Route .....	194
Figure 113 Management > Static Route > IP Static Route > Edit .....	195
Figure 114 Subnet-based Bandwidth Management Example .....	198
Figure 115 Management > Bandwidth MGMT > Summary .....	203
Figure 116 Management > Bandwidth MGMT > Class Setup .....	205
Figure 117 Management > Bandwidth MGMT > Class Setup > Edit .....	206
Figure 118 Management > Bandwidth MGMT > Monitor .....	208
Figure 119 Management > Remote MGMT > WWW .....	210
Figure 120 Management > Remote MGMT > Telnet .....	211
Figure 121 Management > Remote MGMT > FTP .....	211
Figure 122 SNMP Management Model .....	212
Figure 123 Management > Remote MGMT > SNMP .....	214
Figure 124 Management > Remote MGMT > DNS .....	215

Figure 125 Management > Remote MGMT > Security .....	215
Figure 126 Add/Remove Programs: Windows Setup: Communication .....	218
Figure 127 Add/Remove Programs: Windows Setup: Communication: Components .....	219
Figure 128 Network Connections .....	219
Figure 129 Windows Optional Networking Components Wizard .....	220
Figure 130 Networking Services .....	220
Figure 131 Network Connections .....	221
Figure 132 Internet Connection Properties .....	222
Figure 133 Internet Connection Properties: Advanced Settings .....	223
Figure 134 Internet Connection Properties: Advanced Settings: Add .....	223
Figure 135 System Tray Icon .....	224
Figure 136 Internet Connection Status .....	224
Figure 137 Network Connections .....	225
Figure 138 Network Connections: My Network Places .....	226
Figure 139 Network Connections: My Network Places: Properties: Example .....	226
Figure 140 Management > UPnP .....	227
Figure 141 Sharing a USB Printer .....	229
Figure 142 Open Printers Window .....	230
Figure 143 Open Printer Properties .....	231
Figure 144 Printer Properties Window .....	231
Figure 145 Add a Port Window .....	231
Figure 146 Add a Port Wizard .....	232
Figure 147 Enter IP Address of the ZyXEL Device .....	232
Figure 148 Custom Port Settings .....	233
Figure 149 Custom Port Settings .....	233
Figure 150 Finish Adding the TCP/IP Port .....	234
Figure 151 Configuring Print Server .....	234
Figure 152 Printers Folder .....	235
Figure 153 Add Printer Wizard: Welcome .....	236
Figure 154 Add Printer Wizard: Local or Network Printer .....	236
Figure 155 Add Printer Wizard: Select the Printer Port .....	237
Figure 156 Add Printer Wizard: Printer Driver .....	237
Figure 157 Add Printer Wizard: Use Existing Driver .....	238
Figure 158 Add Printer Wizard: Name Your Printer .....	238
Figure 159 Add Printer Wizard: Printer Sharing .....	239
Figure 160 Add Printer Wizard: Print Test Page .....	239
Figure 161 Add Printer Wizard Complete .....	240
Figure 162 Macintosh HD .....	240
Figure 163 Macintosh HD folder .....	240
Figure 164 Applications Folder .....	241
Figure 165 Utilities Folder .....	241
Figure 166 Printer List Folder .....	241
Figure 167 Printer Configuration .....	242



Figure 168 Printer Model .....	242
Figure 169 Print Server .....	242
Figure 170 File Sharing Overview .....	243
Figure 171 Check the Workgroup Name .....	245
Figure 172 File Sharing Login .....	245
Figure 173 Management > File Sharing .....	246
Figure 174 File Sharing via Windows Explorer .....	248
Figure 175 Run Utility to Browse Files .....	248
Figure 176 Browse to a File Share via Workgroup Name .....	249
Figure 177 Maintenance > System > General .....	254
Figure 178 Maintenance > System > Dynamic DNS .....	256
Figure 179 Maintenance > System > Time Setting .....	258
Figure 180 Maintenance > Logs > View Log .....	262
Figure 181 Maintenance > Logs > Log Settings .....	263
Figure 182 Maintenance > Tools > Firmware .....	273
Figure 183 Firmware Upload In Process .....	274
Figure 184 Network Temporarily Disconnected .....	274
Figure 185 Firmware Upload Error .....	275
Figure 186 Maintenance > Tools > Configuration .....	275
Figure 187 Configuration Upload Successful .....	276
Figure 188 Network Temporarily Disconnected .....	276
Figure 189 Configuration Upload Error .....	277
Figure 190 Maintenance > Tools > Restart .....	277
Figure 191 Maintenance > Tools > Restart > In Progress .....	277
Figure 192 Outgoing Calls: Default .....	283
Figure 193 Outgoing Calls: Individual Configuration .....	283
Figure 194 Incoming Calls: Default .....	284
Figure 195 Incoming Calls: Individual Configuration .....	284
Figure 196 Pop-up Blocker .....	294
Figure 197 Internet Options .....	294
Figure 198 Internet Options .....	295
Figure 199 Pop-up Blocker Settings .....	295
Figure 200 Internet Options .....	296
Figure 201 Security Settings - Java Scripting .....	297
Figure 202 Security Settings - Java .....	297
Figure 203 Java (Sun) .....	298
Figure 204 Network Number and Host ID .....	300
Figure 205 Subnetting Example: Before Subnetting .....	302
Figure 206 Subnetting Example: After Subnetting .....	303
Figure 207 WIndows 95/98/Me: Network: Configuration .....	308
Figure 208 Windows 95/98/Me: TCP/IP Properties: IP Address .....	309
Figure 209 Windows 95/98/Me: TCP/IP Properties: DNS Configuration .....	310
Figure 210 Windows XP: Start Menu .....	311

Figure 211 Windows XP: Control Panel .....	311
Figure 212 Windows XP: Control Panel: Network Connections: Properties .....	312
Figure 213 Windows XP: Local Area Connection Properties .....	312
Figure 214 Windows XP: Internet Protocol (TCP/IP) Properties .....	313
Figure 215 Windows XP: Advanced TCP/IP Properties .....	314
Figure 216 Windows XP: Internet Protocol (TCP/IP) Properties .....	315
Figure 217 Macintosh OS X: Apple Menu .....	315
Figure 218 Macintosh OS X: Network .....	316
Figure 219 Red Hat 9.0: KDE: Network Configuration: Devices .....	317
Figure 220 Red Hat 9.0: KDE: Ethernet Device: General .....	318
Figure 221 Red Hat 9.0: KDE: Network Configuration: DNS .....	318
Figure 222 Red Hat 9.0: KDE: Network Configuration: Activate .....	319
Figure 223 Red Hat 9.0: Dynamic IP Address Setting in ifconfig-eth0 .....	319
Figure 224 Red Hat 9.0: Static IP Address Setting in ifconfig-eth0 .....	319
Figure 225 Red Hat 9.0: DNS Settings in resolv.conf .....	320
Figure 226 Red Hat 9.0: Restart Ethernet Card .....	320
Figure 227 Red Hat 9.0: Checking TCP/IP Properties .....	320
Figure 228 Configuration Text File Format: Column Descriptions .....	323
Figure 229 Invalid Parameter Entered: Command Line Example .....	324
Figure 230 Valid Parameter Entered: Command Line Example .....	324
Figure 231 Internal SPTGEN FTP Download Example .....	325
Figure 232 Internal SPTGEN FTP Upload Example .....	325

# List of Tables

Table 1 LED Descriptions .....	37
Table 2 Web Configurator Icons in the Title Bar .....	43
Table 3 Navigation Panel Summary .....	43
Table 4 Main Wizard Screen .....	48
Table 5 Connection Wizard > Welcome .....	49
Table 6 Connection Wizard > System Information .....	50
Table 7 Connection Wizard > ISP Parameters (Ethernet) .....	50
Table 8 Connection Wizard > ISP Parameters (PPPoE) .....	51
Table 9 Connection Wizard > IP Address .....	52
Table 10 Connection Wizard > IP Address (Ethernet) .....	53
Table 11 Connection Wizard > IP Address (PPPoE) .....	55
Table 12 Connection Wizard > MAC Address .....	56
Table 13 Connection Wizard > Finish .....	57
Table 14 VoIP Setup Wizard > SIP Settings .....	58
Table 15 VoIP Setup Wizard > Registration Complete (Success) .....	59
Table 16 VoIP Setup Wizard > Registration Complete (Fail) .....	60
Table 17 Bandwidth Management Wizard > Welcome .....	61
Table 18 Bandwidth Management Wizard > General Information .....	62
Table 19 Bandwidth Management Wizard > Services Setup .....	63
Table 20 Bandwidth Management Wizard > Priority Setup .....	64
Table 21 Bandwidth Management Wizard > Finish .....	65
Table 22 Status Screen .....	68
Table 23 Any IP Table Window .....	71
Table 24 DHCP Table Window .....	71
Table 25 VoIP Statistics Window .....	72
Table 26 BW MGMT Monitor Window .....	74
Table 27 Packet Statistics Window .....	75
Table 28 Types of Encryption for Each Type of Authentication .....	81
Table 29 Additional Wireless Terms .....	82
Table 30 Wireless LAN: General .....	83
Table 31 Wireless No Security .....	84
Table 32 Wireless: Static WEP Encryption .....	85
Table 33 Wireless: WPA(2)-PSK .....	86
Table 34 Wireless: WPA(2) .....	87
Table 35 Network > Wireless LAN > OTIST .....	89
Table 36 MAC Address Filter .....	92
Table 37 Wireless LAN: Advanced .....	93
Table 38 Private IP Address Ranges .....	95

Table 39 Network > WAN > Internet Connection (Ethernet) .....	98
Table 40 Network > WAN > Internet Connection (Roadrunner) .....	99
Table 41 Network > WAN > Internet Connection (PPPoE) .....	100
Table 42 Network > WAN > Advanced .....	102
Table 43 Network > WAN > Traffic Redirect .....	104
Table 44 Network > LAN > IP .....	110
Table 45 Network > LAN > DHCP Setup .....	110
Table 46 Network > LAN > Static DHCP .....	112
Table 47 Network > LAN > Client List .....	112
Table 48 Network > LAN > IP Alias .....	113
Table 49 Network > LAN > Advanced .....	115
Table 50 Network > NAT > General .....	120
Table 51 Network > NAT > Port Forwarding .....	121
Table 52 Network > NAT > Port Forwarding > Edit .....	122
Table 53 Network > NAT > Trigger Port .....	123
Table 54 Network > NAT > ALG .....	123
Table 55 SIP Call Progression .....	128
Table 56 Custom Tones Details .....	132
Table 57 VoIP > SIP > SIP Settings .....	135
Table 58 VoIP > SIP > SIP Settings > Advanced .....	137
Table 59 VoIP > SIP > QoS .....	140
Table 60 European Type Flash Key Commands .....	142
Table 61 USA Type Flash Key Commands .....	143
Table 62 VoIP > Phone > Analog Phone .....	145
Table 63 VoIP > Phone > Analog Phone > Advanced .....	146
Table 64 DECT Phone Calls Summary .....	149
Table 65 VoIP > Phone > DECT Phone .....	151
Table 66 VoIP > Phone > Common .....	152
Table 67 VoIP > Phone > Region .....	153
Table 68 VoIP > Phone Book > Incoming Call Policy .....	156
Table 69 VoIP > Phone Book > Speed Dial .....	157
Table 70 VoIP > PSTN Line > General .....	160
Table 71 Matching Incoming and Outgoing Authentication .....	162
Table 72 Call Rules .....	163
Table 73 VoIP > Trunking > General .....	165
Table 74 VoIP > Trunking > Peer Call .....	166
Table 75 VoIP > Trunking > Call Rule .....	168
Table 76 VoIP Trunking Call Progression .....	171
Table 77 PSTN to PSTN: VoIP Trunking Call Progression .....	175
Table 78 Security > Firewall > General .....	183
Table 79 Security > Firewall > Services .....	184
Table 80 Security > Content Filter > Filter .....	188
Table 81 Security > Content Filter > Schedule .....	189

Table 82 Management > Static Route > IP Static Route .....	194
Table 83 Management > Static Route > IP Static Route > Edit .....	195
Table 84 Application and Subnet-based Bandwidth Management Example .....	198
Table 85 Maximize Bandwidth Usage Example .....	199
Table 86 Priority-based Allotment of Unused & Unbudgeted Bandwidth Example .....	200
Table 87 Fairness-based Allotment of Unused & Unbudgeted Bandwidth Example .....	200
Table 88 Bandwidth Borrowing Example .....	201
Table 89 Over Allotment of Bandwidth Example .....	202
Table 90 Management > Bandwidth MGMT > Summary .....	203
Table 91 Management > Bandwidth MGMT > Class Setup .....	205
Table 92 Management > Bandwidth MGMT > Class Setup > Edit .....	206
Table 93 Management > Bandwidth MGMT > Monitor .....	208
Table 94 .....	209
Table 95 Management > Remote MGMT > WWW .....	210
Table 96 Management > Remote MGMT > Telnet .....	211
Table 97 Management > Remote MGMT > FTP .....	211
Table 98 SNMP Traps .....	213
Table 99 Remote Management: SNMP .....	214
Table 100 Management > Remote MGMT > DNS .....	215
Table 101 Management > Remote MGMT > Security .....	216
Table 102 Management > UPnP .....	227
Table 103 Configuring Print Server .....	234
Table 104 Management > File Sharing .....	246
Table 105 Maintenance > System > General .....	254
Table 106 Maintenance > System > Dynamic DNS .....	256
Table 107 Pre-defined NTP Time Servers .....	257
Table 108 Maintenance > System > Time Setting .....	258
Table 109 Syslog Logs .....	261
Table 110 Maintenance > Logs > View Log .....	262
Table 111 Maintenance > Logs > Log Settings .....	263
Table 112 System Error Logs .....	265
Table 113 System Maintenance Logs .....	265
Table 114 Access Control Logs .....	266
Table 115 TCP Reset Logs .....	266
Table 116 Packet Filter Logs .....	267
Table 117 ICMP Logs .....	267
Table 118 PPP Logs .....	267
Table 119 UPnP Logs .....	268
Table 120 Content Filtering Logs .....	268
Table 121 Attack Logs .....	268
Table 122 Remote Management Logs .....	269
Table 123 ICMP Notes .....	270
Table 124 SIP Logs .....	271

Table 125 RTP Logs .....	271
Table 126 Lifeline Logs .....	271
Table 127 Maintenance > Tools > Firmware .....	274
Table 128 Maintenance > Tools > Configuration .....	275
Table 129 Device Specifications .....	287
Table 130 Firmware Features .....	288
Table 131 Feature Specifications .....	289
Table 132 ZyXEL Device Power Adaptor Specifications .....	290
Table 133 .....	300
Table 134 Subnet Masks .....	301
Table 135 Maximum Host Numbers .....	301
Table 136 Alternative Subnet Mask Notation .....	301
Table 137 Subnet 1 .....	303
Table 138 Subnet 2 .....	304
Table 139 Subnet 3 .....	304
Table 140 Subnet 4 .....	304
Table 141 Eight Subnets .....	304
Table 142 24-bit Network Number Subnet Planning .....	305
Table 143 16-bit Network Number Subnet Planning .....	305
Table 144 Abbreviations Used in the Example Internal SPTGEN Screens Table .....	326
Table 145 Menu 1 General Setup .....	326
Table 146 Menu 3 .....	326
Table 147 Menu 4 Internet Access Setup .....	329
Table 148 Menu 12 .....	331
Table 149 Menu 15 SUA Server Setup .....	331
Table 150 Menu 21.1 Filter Set #1 .....	333
Table 151 Menu 21.1 Filter Set #2 .....	334
Table 152 Menu 23 System Menus .....	336
Table 153 Menu 24.11 Remote Management Control .....	337
Table 154 Command Examples .....	338
Table 155 Examples of Services .....	339

---

# PART I

## Introduction, Wizards and Status

---

- Introducing the ZyXEL Device (33)
- Introducing the Web Configurator (39)
- Wizard Setup (47)
- Status Screens (67)





# Introducing the ZyXEL Device

This chapter introduces the main applications and features of the ZyXEL Device.

## 1.1 Overview

This user's guide explains how to configure the following ZyXEL devices:

- The P-2302HWUD-P1 is a 4-port wireless router with Voice over IP (VoIP) communication capabilities that allow you to use a traditional analog telephone to make Internet calls. The P-2302HWUD-P1 is also a complete security solution with a robust firewall and content filtering.
- The P-2302HWUDL-P1 adds a Public Switched Telephone Network (PSTN) line feature which allows you to use your regular phone services and internet telephone services at the same time.

This user's guide refers to these models simply as the "ZyXEL Device". Please refer to [Appendix A on page 287](#) for a complete list of features for your model.

### 1.1.1 VoIP Features

You can use the ZyXEL Device to make and receive VoIP telephone calls:

**Figure 1** ZyXEL Device's VoIP Features

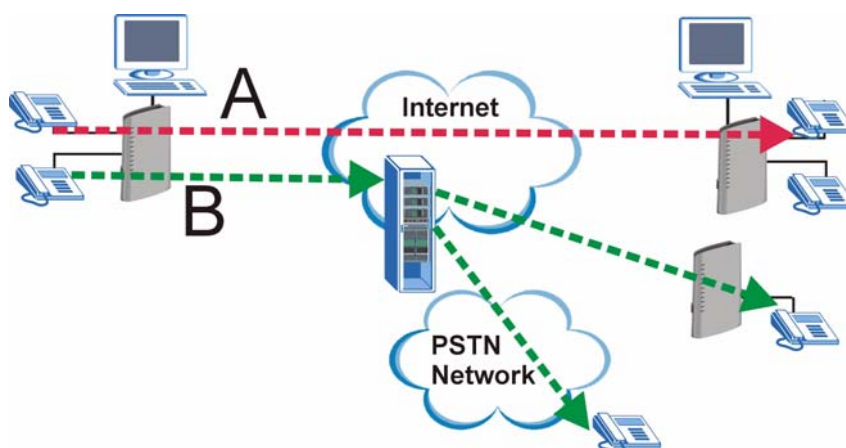

- Peer-to-Peer calls (**A**) - Use the ZyXEL Device to make a call to the recipient's IP address without using a SIP proxy server.
- Calls via a VoIP service provider (**B**) - The ZyXEL Device sends your call to a VoIP service provider's SIP server which forwards your calls to either VoIP or PSTN phones.

## 1.1.2 VoIP Trunking Gateway

VoIP trunking allows you to use your ZyXEL Device as a gateway between VoIP and PSTN networks.

**Figure 2** ZyXEL Device as a VoIP Trunking Gateway

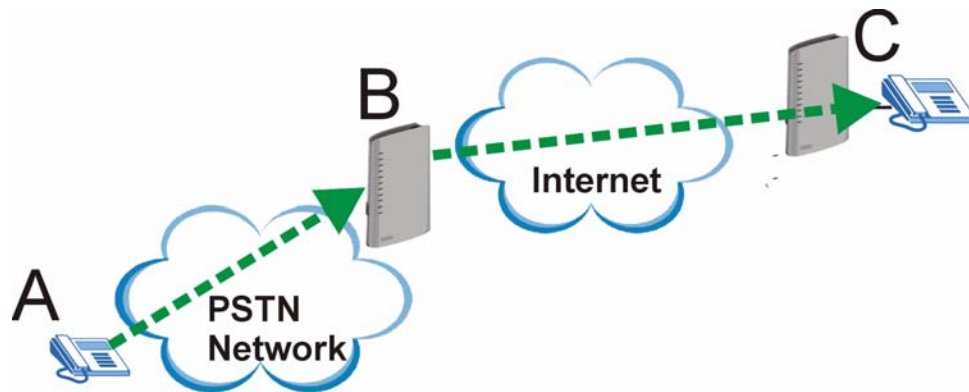

In this example, you use your analog phone (A) to call the ZyXEL Device (B). The ZyXEL Device changes the call into VoIP and sends it via the Internet to another VoIP phone (C).

## 1.1.3 DECT Base Station Feature

Your ZyXEL Device has a built in Digital Enhanced Cordless Telecommunications (DECT) base station. DECT is an ETSI (European Telecommunications Standards Institute) standard for digital cordless phones which specifies how they transmit, receive and process data and voice communication. You can register any DECT GAP phone with the ZyXEL Device.

**Figure 3** DECT Base Station Feature

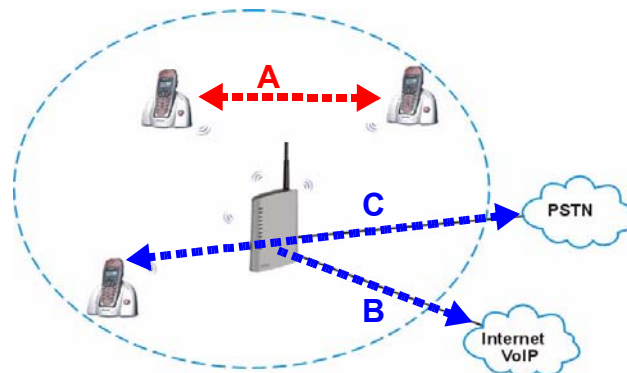

You can use your DECT phone to make calls to other DECT phones registered with the ZyXEL Device (A). These calls are referred to as internal calls.

You can also use your DECT phone to make VoIP calls (B). For the PSTN models, you can also make calls via the PSTN line (C). These types of calls are referred to as external calls.

### 1.1.4 ZyXEL Device's USB Support

Use the built-in USB 2.0 ports to share files via a USB memory stick or a USB hard drive (**A**). You can also add a printer (**B**) and make it available on your local area network.

**Figure 4** File Sharing Overview

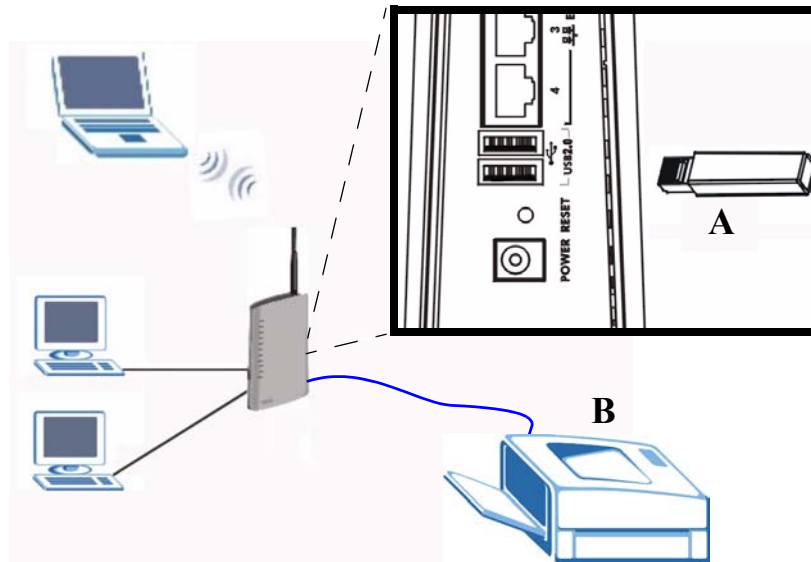

### 1.1.5 ZyXEL Device's Router Features

Your ZyXEL Device provides shared Internet access through your existing Internet access gateway (company network, or your cable or DSL modem for example). Computers can connect to the ZyXEL Device's LAN ports (or wirelessly).

**Figure 5** ZyXEL Device's Router Features

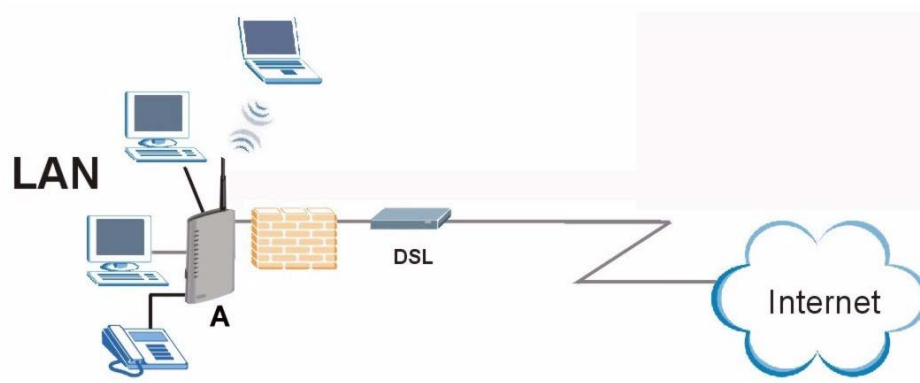

You can also configure firewall and content filtering on the ZyXEL Device for secure Internet access. When the firewall is on, all incoming traffic from the Internet to your network is blocked unless it is initiated from your network. This means that probes from the outside to your network are not allowed, but you can safely browse the Internet and download files.

Use content filtering to block access to specific web sites, with URL's containing keywords that you specify. You can define time periods and days during which content filtering is enabled and include or exclude particular computers on your network from content filtering. For example, you could block access to certain web sites for the kids.

Use bandwidth management to efficiently manage traffic on your network by giving priority to certain types of traffic and/or to particular computers. For example, you could make sure that the ZyXEL Device gives voice over Internet calls high priority, and/or limit bandwidth devoted to the boss's excessive file downloading.

## 1.2 Ways to Manage the ZyXEL Device

Use any of the following methods to manage the ZyXEL Device.

- Web Configurator. This is recommended for everyday management of the ZyXEL Device using a web browser.
- Command Line Interface. Line commands are mostly used for troubleshooting by service engineers.
- FTP for firmware upgrades and configuration backup/restore ([Chapter 18 on page 211](#))
- SNMP. The device can be monitored by an SNMP manager. See the SNMP chapter in this User's Guide.
- SPTGEN. SPTGEN is a text configuration file that allows you to configure the device by uploading an SPTGEN file. This is especially convenient if you need to configure many devices of the same type.

## 1.3 Good Habits for Managing the ZyXEL Device

Do the following things regularly to make the ZyXEL Device more secure and to manage the ZyXEL Device more effectively.

- Change the password. Use a password that's not easy to guess and that consists of different types of characters, such as numbers and letters.
- Write down the password and put it in a safe place.
- Back up the configuration (and make sure you know how to restore it). Restoring an earlier working configuration may be useful if the device becomes unstable or even crashes. If you forget your password, you will have to reset the ZyXEL Device to its factory default settings. If you backed up an earlier configuration file, you would not have to totally re-configure the ZyXEL Device. You could simply restore your last configuration.

## 1.4 LEDs (Lights)

The following graphic displays the labels of the LEDs.

Figure 6 LEDs

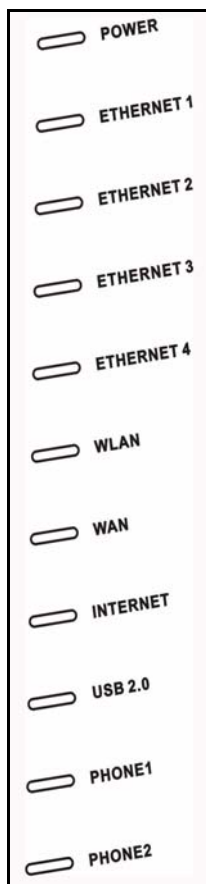

None of the LEDs are on if the ZyXEL Device is not receiving power.

Table 1 LED Descriptions

LED	COLOR	STATUS	DESCRIPTION
POWER	Green	On	The ZyXEL Device is receiving power and ready for use.
		Blinking	The ZyXEL Device is self-testing.
	Red	On	The ZyXEL Device detected an error while self-testing, or there is a device malfunction.
		Off	The ZyXEL Device is not receiving power.
ETHERNET 1-4	Green	On	The ZyXEL Device has an Ethernet connection with a device on the Local Area Network (LAN).
		Blinking	The ZyXEL Device is sending/receiving data to /from the LAN.
		Off	The ZyXEL Device does not have an Ethernet connection with the LAN.
WLAN	Green	On	The wireless network is activated and is operating in IEEE 802.11b/g mode.
		Blinking	The ZyXEL Device is communicating with other wireless clients.
		OFF	The wireless network is not activated.

**Table 1** LED Descriptions

LED	COLOR	STATUS	DESCRIPTION
WAN	Green	On	The ZyXEL Device has an Ethernet connection with the cable/DSL modem.
		Blinking	The ZyXEL Device is sending/receiving data to /from the cable/DSL modem.
	Off	The ZyXEL Device doesn't have an Ethernet connection with the cable/DSL modem.	
INTERNET	Green	On	The ZyXEL Device has a working IP address.
	Red	On	The ZyXEL Device does not have a working IP address, but there is a network connection.
	Off	Off	The ZyXEL Device does not detect any network connection.
USB 2.0	Green	On	The ZyXEL Device recognizes a USB connection.
		Blinking	The ZyXEL Device is sending/receiving data to /from the USB device connected to it.
	Off	Off	The ZyXEL Device does not detect a USB connection.
PHONE 1-2	Green	On	A SIP account on this phone port is registered.
		Blinking	The phone is off the hook.
	Orange	On	There is a voice message for a SIP account on this phone port. (The SIP account has to be registered first.)
		Blinking	The phone is off the hook, and there is a voice message for a SIP account on this phone port.
	Off	Off	There are no SIP accounts registered on this phone port.

# Introducing the Web Configurator

This chapter describes how to access the ZyXEL Device web configurator and provides an overview of its screens.

## 2.1 Web Configurator Overview

The web configurator is an HTML-based management interface that allows easy ZyXEL Device setup and management via Internet browser. Use Internet Explorer 6.0 and later or Netscape Navigator 7.0 and later versions. The recommended screen resolution is 1024 by 768 pixels.

In order to use the web configurator you need to allow:

- Web browser pop-up windows from your device. Web pop-up blocking is enabled by default in Windows XP SP (Service Pack) 2.
- JavaScripts (enabled by default).
- Java permissions (enabled by default).

See the troubleshooting chapter if you want to make sure these functions are allowed in Internet Explorer or Netscape Navigator.

## 2.2 Accessing the Web Configurator

- 1 Make sure your ZyXEL Device hardware is properly connected and prepare your computer/computer network to connect to the ZyXEL Device (refer to the Quick Start Guide).
- 2 Launch your web browser.
- 3 Type "192.168.1.1" (the ZyXEL Device's default LAN IP address) as the URL. The **Login** screen appears.

**Figure 7** Login Screen



- 4 Type "1234" (default) as the password, and click **Login**. In some versions, the default password appears automatically - if this is the case, click **Login**. The **Change Password** screen appears.

**Figure 8** Change Password Screen



- 5 It is highly recommended to change your password. To change your password, type a new password, retype it to confirm it, and click **Apply**. Otherwise, click **Ignore** if you do not want to change your password right now. The **Options** screen should appear.



Figure 9 Select Mode Screen

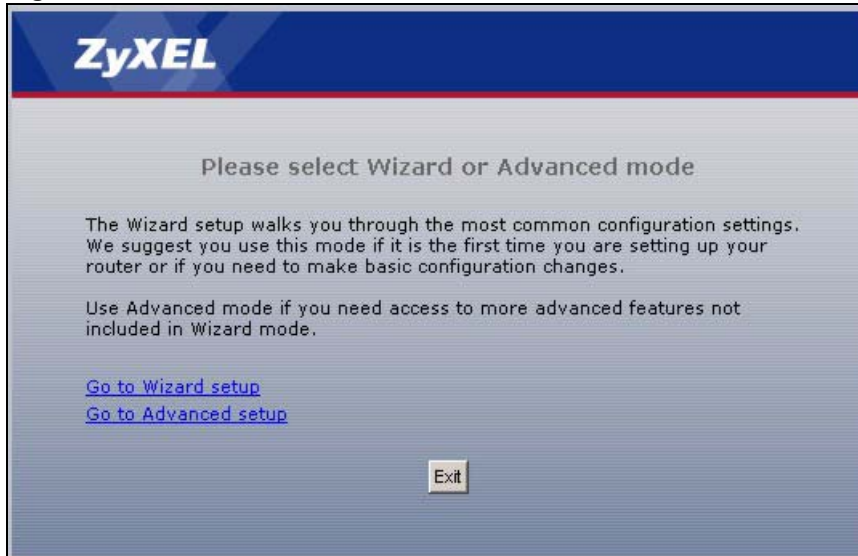

**6** In the **Options** screen,

- Click **Go to Wizard setup** if you are logging in for the first time or if you want to make basic changes. See [Chapter 3 on page 47](#) for more information.
- Click **Go to Advanced setup** if you want to configure features that are not available in the wizards. The main screen appears. See [Section 2.4 on page 42](#) for more information.
- Click **Exit** if you want to log out.



---

**For security reasons, the ZyXEL Device automatically logs you out if you do not use the web configurator for five minutes. If this happens, log in again.**

---

## 2.3 Resetting the ZyXEL Device

Reset the ZyXEL Device in the following situations:

- You forgot your password.
- You cannot access the device using the web configurator. Check **Troubleshooting** in the **Quick Start Guide** to make sure you cannot access the device anymore.

If you reset the ZyXEL Device, you lose all of the changes you have made. The ZyXEL Device re-loads its default settings, and the password resets to “1234”. You have to make all of your changes again.



---

**You will lose all of your changes when you push the RESET button.**

---

To reset the ZyXEL Device,

- 1 Make sure the **POWER** LED is on and not blinking.
- 2 Press and hold the **RESET** button for ten seconds. Release the **RESET** button when the **POWER** LED begins to blink. The default settings have been restored.

If the ZyXEL Device restarts automatically, wait for the ZyXEL Device to finish restarting, and log in to the web configurator. The password is “1234”. You have finished.

If the ZyXEL Device does not restart automatically, disconnect and reconnect the ZyXEL Device’s power. Then, follow the directions above again.

### 2.3.1 Reset Button and WLAN

You can also use the RESET button to turn on/off your wireless network. Press the RESET button for 1 second to turn on/off the WLAN.

## 2.4 Web Configurator Main Screen

Figure 10 Main Screen

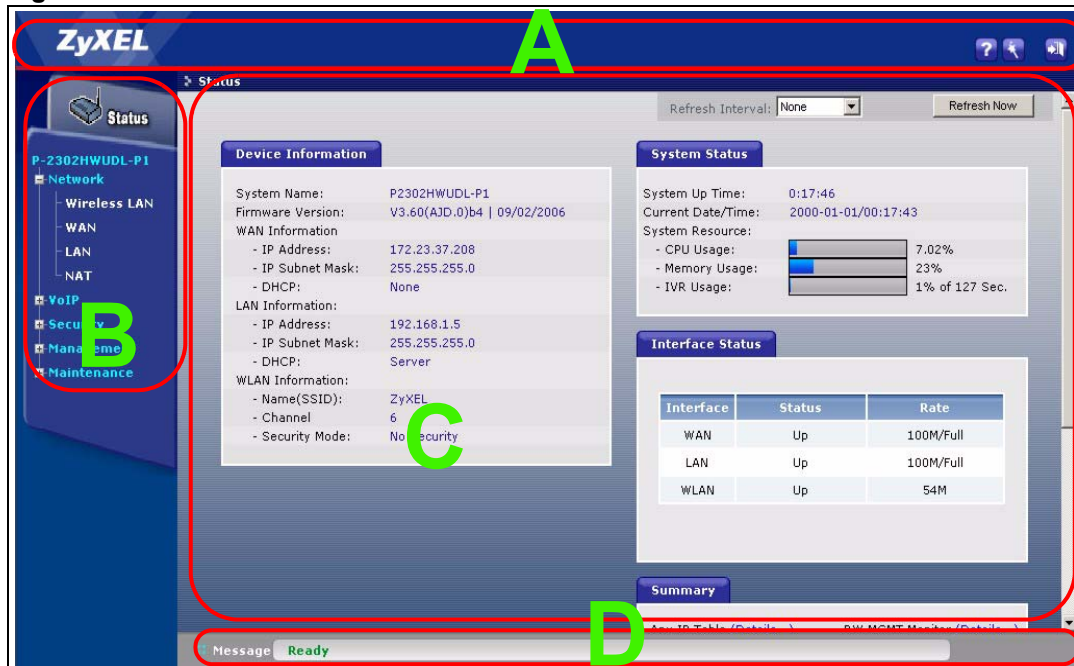

As illustrated above, the main screen is divided into these parts:

- **A** - title bar
- **B** - navigation panel
- **C** - main window
- **D** - status bar



## 2.4.1 Title Bar

The title bar provides some icons in the upper right corner.



The icons provide the following functions.

**Table 2** Web Configurator Icons in the Title Bar

ICON	DESCRIPTION
	<b>Wizards:</b> Click this icon to open one of the web configurator wizards. See <a href="#">Chapter 3 on page 47</a> for more information.
	<b>Logout:</b> Click this icon to log out of the web configurator.

## 2.4.2 Navigation Panel

Use the menu items on the navigation panel to open screens to configure ZyXEL Device features. The following tables describe each menu item.

**Table 3** Navigation Panel Summary

LINK	TAB	FUNCTION
Status		This screen contains administrative and system-related information.
Network		
Wireless LAN	General	Use this screen to configure the wireless LAN settings and WLAN authentication/security settings.
	OTIST	Use this screen to assign your wireless security settings to wireless clients.
	MAC Filter	Use this screen to configure the ZyXEL Device to give exclusive access to specific wireless clients or exclude specific wireless clients from accessing the ZyXEL Device.
	Advanced	Use this screen to configure wireless features such as the transmission mode.
WAN	Internet Connection	Use this screen to set up ISP parameters, IP addresses, and MAC addresses.
	Advanced	Use this screen to set up DNS, RIP, multicasting, and Windows Networking for your WAN port.
	Traffic Redirect	Use this screen to specify up a backup gateway in case the main one is not available.
LAN	IP	Use this screen to set up your LAN's IP address and subnet mask.
	DHCP Setup	Use this screen to configure the ZyXEL Device's DHCP server and DNS server settings.
	Static DHCP	Use this screen to assign static IP addresses to MAC addresses.
	Client List	Use this screen to look at which network clients are using the DHCP server.
	IP Alias	Use this screen to partition your LAN interface into subnets.
	Advanced	Use this screen to set up RIP, multicasting, Any IP, and Windows Networking for your LAN port.

**Table 3** Navigation Panel Summary

LINK	TAB	FUNCTION
NAT	General	Use this screen to enable and disable NAT features.
	Port Forwarding	Use this screen to forward traffic to specific IP addresses based on the destination port.
	Trigger Port	Use this screen to change your ZyXEL Device's trigger port settings.
	ALG	Use this screen to enable and disable the ZyXEL Device's ALG.
VoIP		
SIP	SIP Settings	Use this screen to configure your ZyXEL Device's Voice over IP settings.
	QoS	Use this screen to configure your ZyXEL Device's Quality of Service settings.
Phone	Analog Phone	Use this screen to set up which SIP accounts use which phone ports for incoming and outgoing calls.
	DECT Phone	Use to enable your DECT phone base station and set up a secure password DECT phone registration.
	Common	Use this screen to configure general phone port settings.
	Region	Use this screen to set up regional and call service settings.
Phone Book	Incoming Call Policy	Use this screen to set up call forwarding rules.
	Speed Dial	Use this screen to configure speed dial numbers for SIP phone numbers.
PSTN Line	General	Use this screen to configure your ZyXEL Device's settings for PSTN calls.
Trunking	General	Use this screen to enable trunking on your ZyXEL Device.
	Peer Call	Use this screen to configure peer device authentication for trunking calls.
	Call Rule	Use this screen to configure forwarding rules on your ZyXEL Device for trunking calls.
Security		
Firewall	General	Use this screen to activate/deactivate the firewall and log packets related to firewall rules.
	Services	Use this screen to enable service blocking (LAN to WAN firewall rules).
Content Filter	Filter	Use this screen to block sites containing certain keywords in the URL.
	Schedule	Use this screen to set the days and times for the ZyXEL Device to perform content filtering
Management		
Static Route	IP Static Route	Use this screen to configure IP static routes.
Bandwidth MGMT	Summary	Use this screen to enable bandwidth management on an interface and set the maximum allowed bandwidth and scheduler for the interface.
	Class Setup	Use this screen to define bandwidth classes.
	Monitor	Use this screen to view bandwidth class statistics.

**Table 3** Navigation Panel Summary

LINK	TAB	FUNCTION
Remote MGMT	WWW	Use this screen to configure through which interface(s) and from which IP address(es) users can use HTTP to manage the ZyXEL Device.
	Telnet	Use this screen to configure through which interface(s) and from which IP address(es) users can use Telnet to manage the ZyXEL Device.
	FTP	Use this screen to configure through which interface(s) and from which IP address(es) users can use FTP to access the ZyXEL Device.
	SNMP	Use this screen to configure through which interface(s) and from which IP address(es) users can use SNMP to access the ZyXEL Device.
	DNS	Use this screen to configure through which interface(s) and from which IP address(es) users can send DNS queries to the ZyXEL Device.
	Security	Use this screen to change your anti-probing settings.
Print Server	General	Use this screen to give a name to the printer connected to your ZyXEL Device.
File Sharing	General	Use this screen to enable file sharing via the ZyXEL Device and setup a user's name and password for secure access to your shared files.
UPnP	General	Use this screen to enable UPnP on the ZyXEL Device.
Maintenance		
System	General	Use this screen to configure general system settings.
	Dynamic DNS	Use this screen to set up dynamic DNS.
	Time Setting	Use this screen to change your ZyXEL Device's time and date.
Logs	View Log	Use this screen to view the logs for the categories that you selected.
	Log Settings	Use this screen to change your ZyXEL Device's log settings.
Tools	Firmware	Use this screen to upload firmware to your ZyXEL Device.
	Configuration	Use this screen to backup and restore the configuration or reset the factory defaults to your ZyXEL Device.
	Restart	Use this screen to reboot the ZyXEL Device without turning the power off.

### 2.4.3 Main Window

The main window shows the screen you select in the navigation panel. It is discussed in more detail in the rest of this document.

Right after you log in, the **Status** screen is displayed. See [Chapter 4 on page 67](#) for more information about the **Status** screen.

### 2.4.4 Status Bar

Check the status bar when you click **Apply** or **OK** to verify that the configuration has been updated.



# Wizard Setup

This chapter provides information on the wizards in the web configurator.

## 3.1 Main Wizard Screen

Use this screen to open one of the wizards in the ZyXEL Device. To access this screen, click **Go to Wizard setup** in the **Login Options** screen, or click the **Wizard** icon in the upper right corner of the main screen.

**Figure 11** Main Wizard Screen

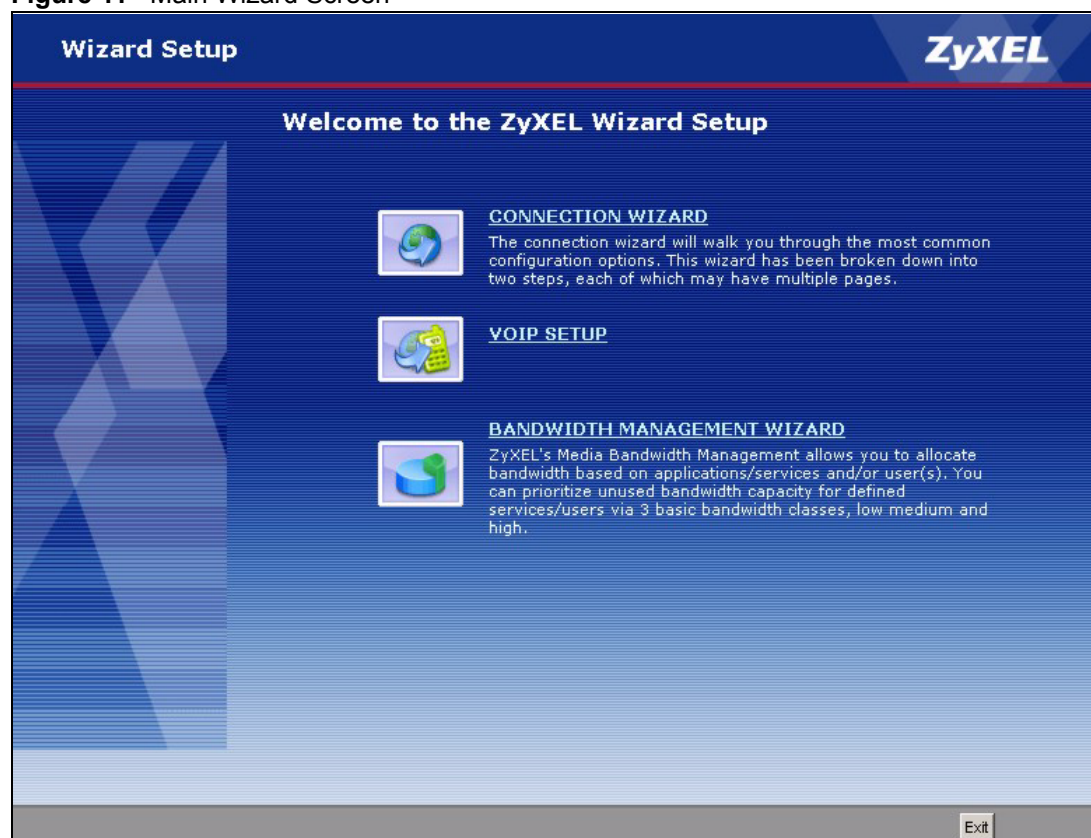

The following table describes the labels in this screen.

**Table 4** Main Wizard Screen

LABEL	DESCRIPTION
CONNECTION WIZARD	Click this to open the Connection Wizard. See <a href="#">Section 3.2 on page 48</a> .
VOIP SETUP	Click this to open the VoIP Setup Wizard. See <a href="#">Section 3.3 on page 57</a> .
BANDWIDTH MANAGEMENT WIZARD	Click this to open the Bandwidth Management Wizard. See <a href="#">Section 3.4 on page 60</a> .
Exit	Click this to close this screen and return to the main screen.

## 3.2 Connection Wizard

Use this wizard to set up your Internet connection. See [Chapter 6 on page 95](#) for more information.



**You cannot use the [Connection Wizard](#) to set up your Internet connection in the following situations:**

- You subscribe to a Roadrunner service.
- You use PPPoE encapsulation and the remote server cannot be discovered automatically.

In these cases, you must use the screens discussed in [Chapter 6 on page 95](#).



**Some ISPs, such as Telstra, send UDP heartbeat packets to verify that the customer is still online. In this case, you have to create a WAN to LAN firewall rule for those packets. Contact your ISP to find the correct port number.**



## 3.2.1 Welcome

Figure 12 Connection Wizard > Welcome

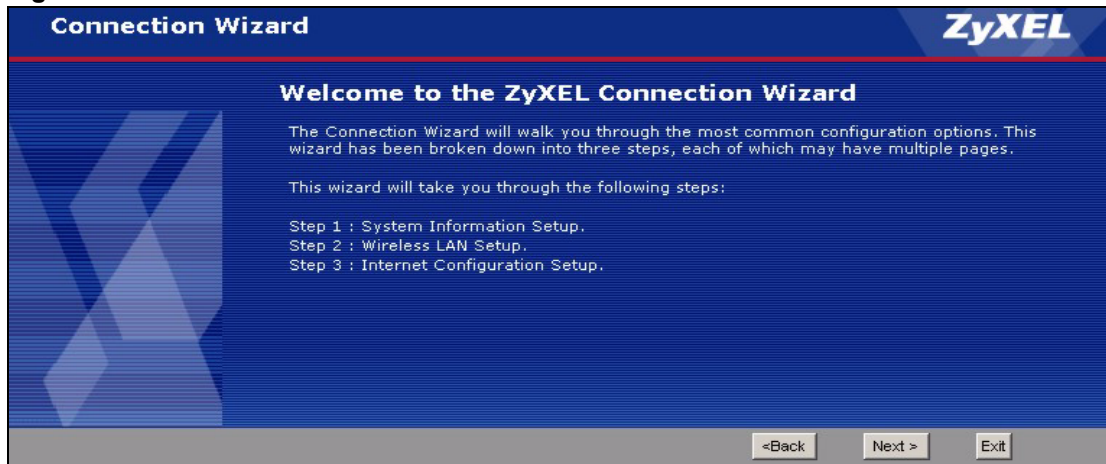

The following table describes the labels in this screen.

Table 5 Connection Wizard > Welcome

LABEL	DESCRIPTION
< Back	Click this to go to the previous screen.
Next >	Click this to go to the next screen.
Exit	Click this to close this screen and return to the main screen.

## 3.2.2 System Information



Usually, you should just click Next in this screen.

Figure 13 Connection Wizard > System Information

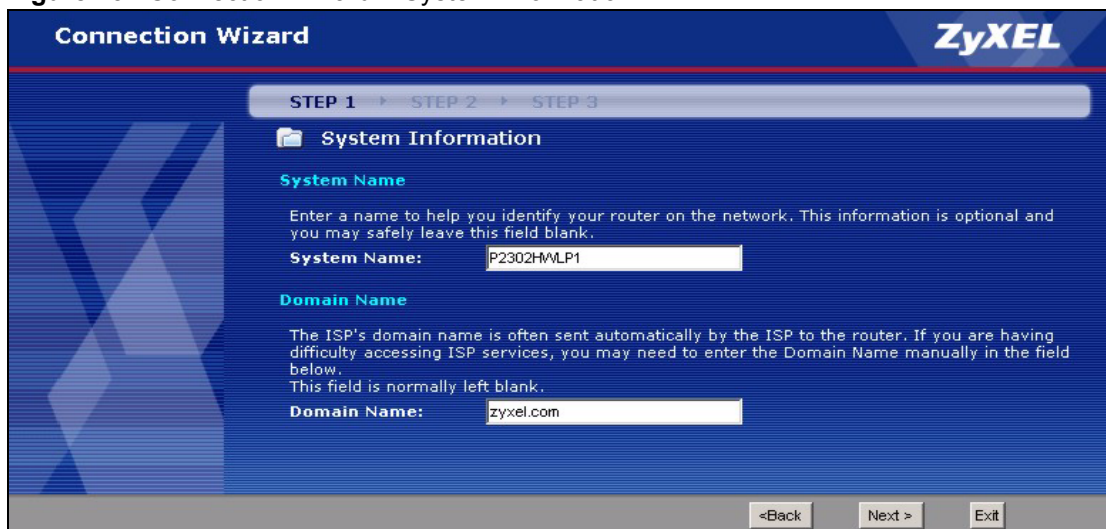

The following table describes the labels in this screen.

**Table 6** Connection Wizard > System Information

LABEL	DESCRIPTION
System Name	Enter your computer's "Computer Name". See <a href="#">Section 22.1 on page 253</a> for more information. This is for identification purposes, but some ISPs also check this field. This name can be up to 30 alphanumeric characters long. Spaces are not allowed, but dashes "-" and underscores "_" are accepted.
Domain Name	Enter the domain name entry that is propagated to DHCP clients on the LAN. If you leave this blank, the domain name obtained from the ISP is used. Use up to 38 alphanumeric characters. Spaces are not allowed, but dashes "-" and periods "." are accepted.
< Back	Click this to go to the previous screen.
Next >	Click this to go to the next screen.
Exit	Click this to close this screen and return to the main screen.

### 3.2.3 ISP Parameters

This screen depends on the **Connection Type** you select.

#### 3.2.3.1 Ethernet



You cannot use the **Connection Wizard** if you subscribe to a Roadrunner service. You must use the screens discussed in [Chapter 6 on page 95](#) instead.

**Figure 14** Connection Wizard > ISP Parameters (Ethernet)

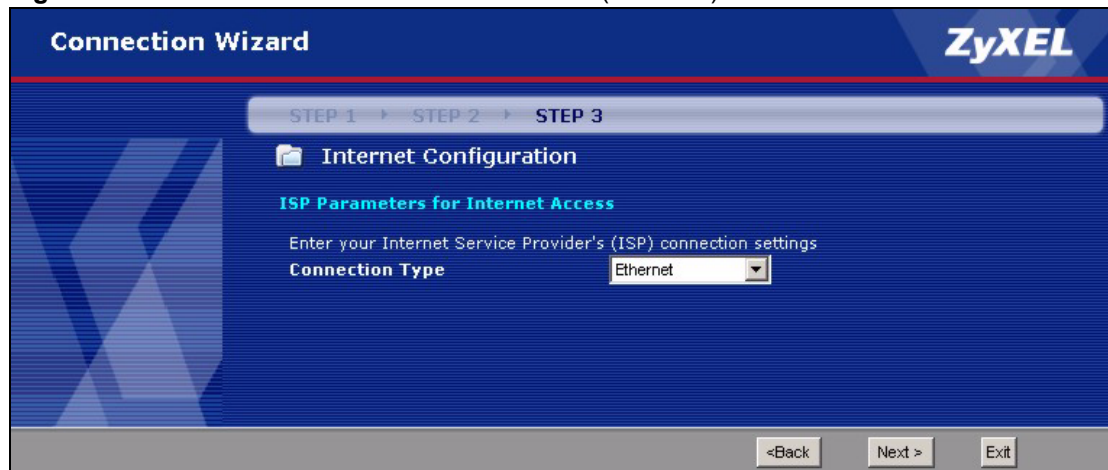

The following table describes the labels in this screen.

**Table 7** Connection Wizard > ISP Parameters (Ethernet)

LABEL	DESCRIPTION
Connection Type	Select <b>Ethernet</b> .
< Back	Click this to go to the previous screen.

**Table 7** Connection Wizard > ISP Parameters (Ethernet)

LABEL	DESCRIPTION
Next >	Click this to go to the next screen.
Exit	Click this to close this screen and return to the main screen.

### 3.2.3.2 PPPoE

Point-to-Point Protocol over Ethernet (PPPoE) functions as a dial-up connection. PPPoE is an IETF (Internet Engineering Task Force) standard specifying how a host personal computer interacts with a broadband modem (for example DSL, cable, wireless, etc.) to achieve access to high-speed data networks.



You cannot use the **Connection Wizard** if the PPPoE remote server cannot be discovered automatically. You must use the screens discussed in **Chapter 6** on **page 95** instead.

**Figure 15** Connection Wizard > ISP Parameters (PPPoE)

The following table describes the labels in this screen.

**Table 8** Connection Wizard > ISP Parameters (PPPoE)

LABEL	DESCRIPTION
Connection Type	Select <b>PPP over Ethernet</b> .
Service Name	Enter the PPP service name provided by your ISP. If your ISP did not provide a service name, leave this field blank.
User Name	Enter the user name provided by your ISP.
Password	Enter the password provided by your ISP.
< Back	Click this to go to the previous screen.
Next >	Click this to go to the next screen.
Exit	Click this to close this screen and return to the main screen.

### 3.2.4 Your IP Address

Figure 16 Connection Wizard > IP Address

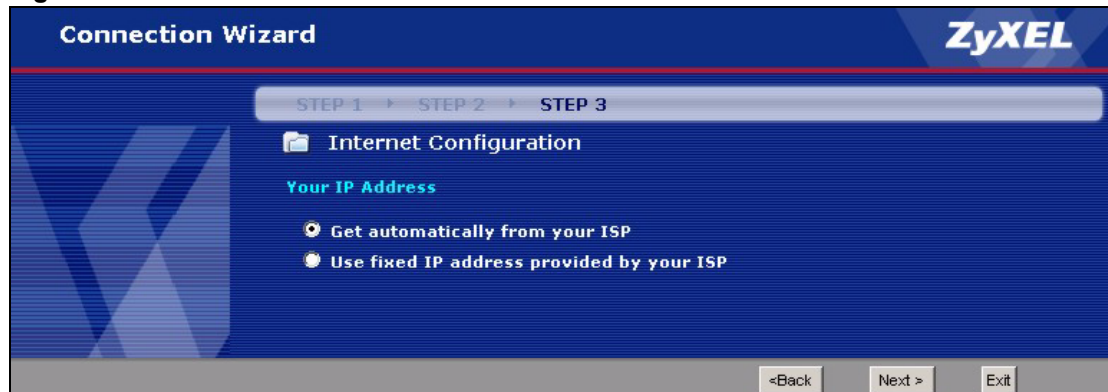

The following table describes the labels in this screen.

Table 9 Connection Wizard > IP Address

LABEL	DESCRIPTION
Get automatically from your ISP	Select this if your ISP did not assign you a static IP address.
Use fixed IP address provided by your ISP	Select this if your ISP assigned you a static IP address.
< Back	Click this to go to the previous screen.
Next >	Click this to go to the next screen.
Exit	Click this to close this screen and return to the main screen.

### 3.2.5 WAN IP Address Assignment

This screen appears if you select **Use fixed IP address provided by your ISP** in the previous screen. Use this screen to set up your static IP address. The fields depend on the **Connection Type** you select in the [ISP Parameters](#) screen.

## 3.2.5.1 Ethernet

Figure 17 Connection Wizard &gt; IP Address (Ethernet)

**Connection Wizard** **ZyXEL**

STEP 1 ▶ STEP 2 ▶ **STEP 3**

**Internet Configuration**

**WAN IP Address Assignment**

My WAN IP Address

My WAN IP Subnet Mask

Gateway IP Address

**DNS Server Address Assignment**

First DNS Server

Second DNS Server

Third DNS Server

<Back    Next >    Exit

The following table describes the labels in this screen.

Table 10 Connection Wizard &gt; IP Address (Ethernet)

LABEL	DESCRIPTION
My WAN IP Address	Enter the IP address provided by your ISP.
My WAN IP Subnet Mask	Enter the subnet mask provided by your ISP.
Gateway IP Address	Enter the gateway provided by your ISP. If your ISP did not provide one, leave it blank.
DNS Server Address Assignment (if applicable) DNS (Domain Name System) is for mapping a domain name to its corresponding IP address and vice versa. The DNS server is extremely important because without it, you must know the IP address of a computer before you can access it. The ZyXEL Device uses a system DNS server (in the order you specify here) to resolve domain names for VPN, DDNS and the time server.	
First DNS Server Second DNS Server Third DNS Server	Select <b>From ISP</b> if your ISP dynamically assigns DNS server information. (In this case, the ISP assigns the WAN IP address too. See <b>Network &gt; WAN &gt; Internet Connection</b> .) The field to the right is read-only, and it displays the IP address provided by your ISP. Select <b>User-Defined</b> if you have the IP address of a DNS server. You might get it from your ISP or from your network. Enter the IP address in the field to the right. Select <b>None</b> if you do not want to use this DNS server. If you select <b>None</b> for all of the DNS servers, you must use IP addresses to configure the ZyXEL Device and to access the Internet.

**Table 10** Connection Wizard > IP Address (Ethernet)

LABEL	DESCRIPTION
< Back	Click this to go to the previous screen.
Next >	Click this to go to the next screen.
Exit	Click this to close this screen and return to the main screen.

### 3.2.5.2 PPPoE



You cannot use the **Connection Wizard** if the PPPoE remote server cannot be discovered automatically.

**Figure 18** Connection Wizard > IP Address (PPPoE)

**Connection Wizard** **ZyXEL**

STEP 1 > STEP 2 > STEP 3

Internet Configuration

**WAN IP Address Assignment**

My WAN IP Address

**DNS Server Address Assignment**

First DNS Server

Second DNS Server

Third DNS Server

<Back    Next >    Exit

The following table describes the labels in this screen.

**Table 11** Connection Wizard > IP Address (PPPoE)

LABEL	DESCRIPTION
My WAN IP Address	Enter the IP address provided by your ISP.
First DNS Server Second DNS Server Third DNS Server	Select <b>From ISP</b> if your ISP dynamically assigns DNS server information. (In this case, the ISP assigns the WAN IP address too. See <b>Network &gt; WAN &gt; Internet Connection</b> .) The field to the right is read-only, and it displays the IP address provided by your ISP. Select <b>User-Defined</b> if you have the IP address of a DNS server. You might get it from your ISP or from your network. Enter the IP address in the field to the right. Select <b>None</b> if you do not want to use this DNS server. If you select <b>None</b> for all of the DNS servers, you must use IP addresses to configure the ZyXEL Device and to access the Internet.
< Back	Click this to go to the previous screen.
Next >	Click this to go to the next screen.
Exit	Click this to close this screen and return to the main screen.

### 3.2.6 MAC Address

**Figure 19** Connection Wizard > MAC Address

**Connection Wizard** **ZyXEL**

STEP 1 → STEP 2 → STEP 3

**Internet Configuration**

**WAN MAC Address**

Users configure the WAN port's MAC address by either using the factory default or cloning the MAC address from a computer on your LAN. Select Factory Default to use the factory assigned default MAC address. Alternatively, select Spoof this Computer's MAC address - IP Address and enter the IP address of the computer on the LAN whose MAC address you are cloning.

**Factory default**  
 **Spoof this computer's MAC Address**  
 IP Address

The following table describes the labels in this screen.

**Table 12** Connection Wizard > MAC Address

LABEL	DESCRIPTION
Factory default	Select this if you want to use the default MAC address for the ZyXEL Device.
Spoof this computer's MAC Address	Select this if you do not want to use the default MAC address for the ZyXEL Device.
IP Address	This field is enabled if you select <b>Spoof WAN MAC Address</b> . Enter the IP address of the computer whose MAC address you want the ZyXEL Device to use instead of the default MAC address.
< Back	Click this to go to the previous screen.
Next >	Click this to configure the ZyXEL Device and go to the next screen.
Exit	Click this to close this screen and return to the main screen.

### 3.2.7 Finish

**Figure 20** Connection Wizard > Finish

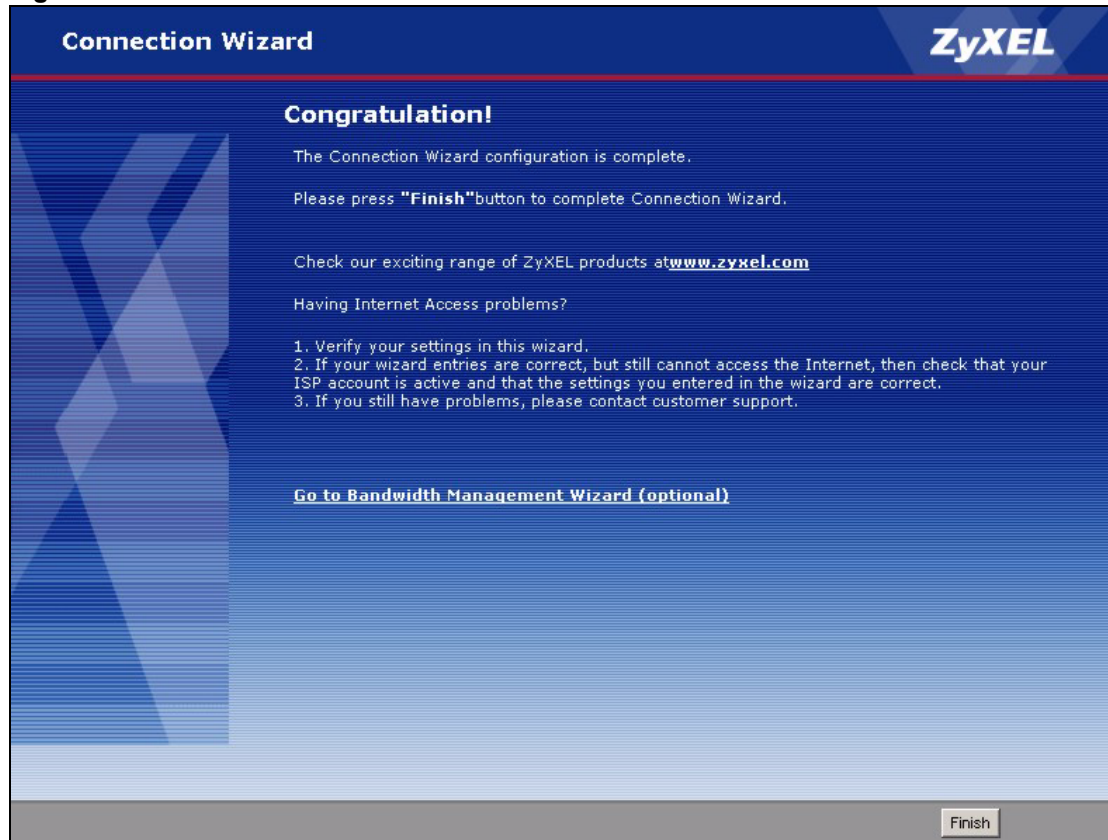



The following table describes the labels in this screen.

**Table 13** Connection Wizard > Finish

LABEL	DESCRIPTION
Go to Bandwidth Management Wizard (optional)	Click this to start the Bandwidth Management Wizard. See <a href="#">Section 3.4 on page 60</a> .
Finish	Click this to close this screen and return to the main screen.

## 3.3 VoIP Setup Wizard

Use this wizard to set up your VoIP account(s). Leave the default settings in fields if your VoIP service provider (the company that lets you make phone calls over the Internet) did not provide any information. See [Chapter 9 on page 127](#) for more information.



**You must have a SIP account before you can use this wizard.**

### 3.3.1 SIP Settings

**Figure 21** VoIP Setup Wizard > SIP Settings

**VoIP Setup** **ZyXEL**

STEP 1 | STEP 2

VoIP Configuration

**SIP1 Settings**

SIP Number: changeme

SIP Server Address: 127.0.0.1

SIP Service Domain: 127.0.0.1

**Authentication**

User Name: changeme

Password: \*\*\*\*\*

Check here to set up SIP2 settings.

<Back Apply Exit

The following table describes the labels in this screen.

**Table 14** VoIP Setup Wizard > SIP Settings

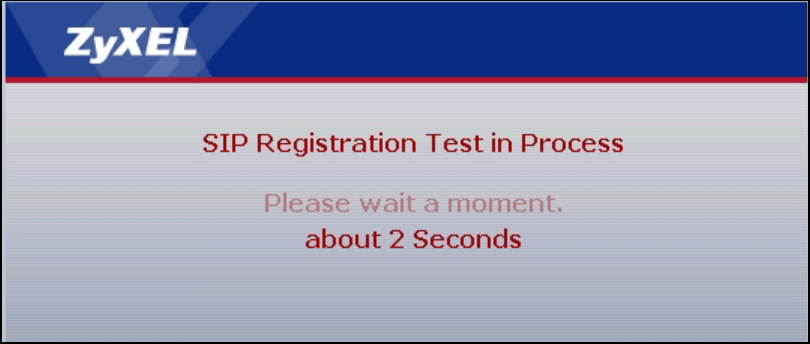
LABEL	DESCRIPTION
SIP1 Settings SIP2 Settings	
SIP Number	Enter your SIP number. In the full SIP URI (like <a href="#">1234@VoIP-provider.com</a> ), this is the part before the @ symbol. You can use up to 127 printable ASCII characters.
SIP Server Address	Enter the IP address or domain name of the SIP server provided by your VoIP service provider. You can use up to 95 printable ASCII characters. It does not matter whether the SIP server is a proxy, redirect or register server.
SIP Service Domain	Enter the SIP service domain name. In the full SIP URI (like <a href="#">1234@VoIP-provider.com</a> ), this is the part after the @ symbol. You can use up to 127 printable ASCII Extended set characters.
Authentication	
User Name	Enter the user name for registering this SIP account, exactly as it was given to you. You can use up to 95 printable ASCII characters.
Password	Enter the user name for registering this SIP account, exactly as it was given to you. You can use up to 95 printable ASCII Extended set characters.
Check here to set up SIP2 settings	This field is available in the <b>SIP1 Settings</b> screen. Select this if you want to set up the SIP2 account, as well as the SIP1 account.
< Back	Click this to go to the previous screen.
Next >	Click this to go to the next screen. If you select <b>Check here to set up SIP2 settings</b> , the <a href="#">SIP Settings</a> screen appears again for SIP2. Otherwise, the ZyXEL Device tries to register your SIP account(s). The following screen appears.  <b>Figure 22</b> VoIP Setup Wizard > Registration Test  Wait until it finishes.
Exit	Click this to close this screen and return to the main screen.

### 3.3.2 Registration Complete

This screen depends on whether or not the ZyXEL Device successfully registered your SIP account(s).

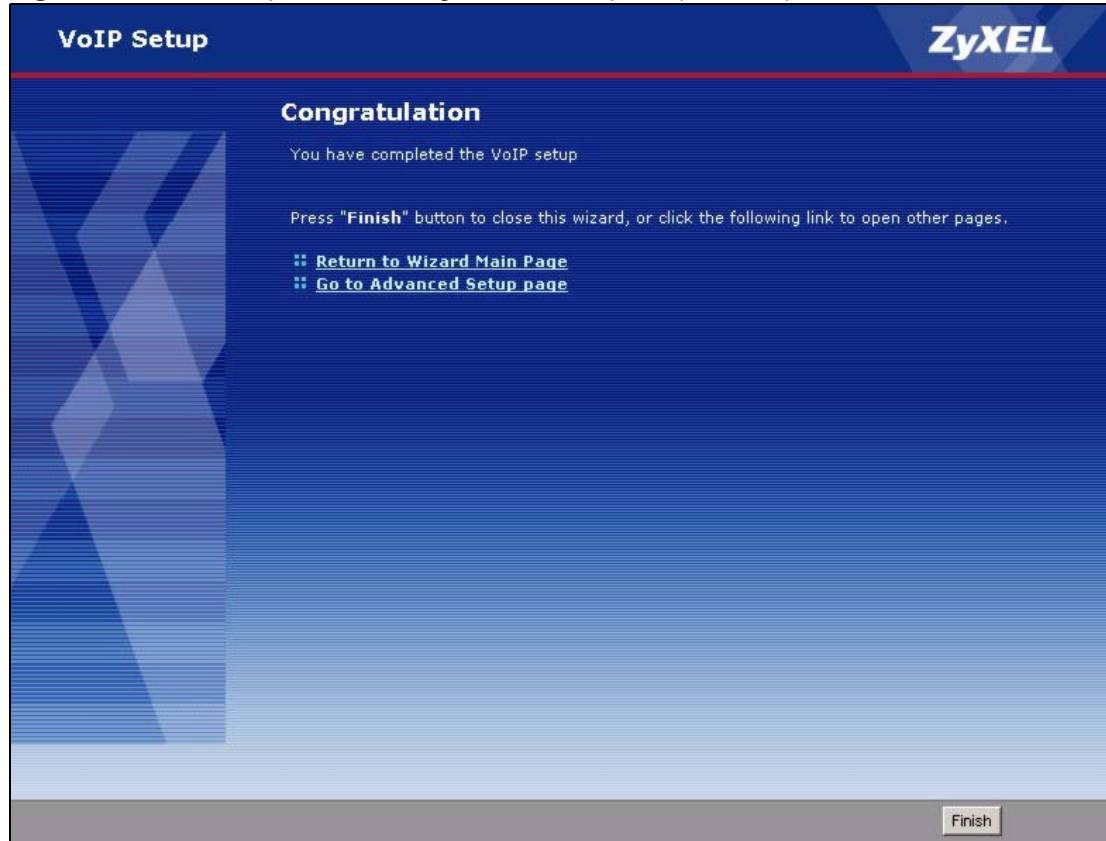
**Figure 23** VoIP Setup Wizard > Registration Complete (Success)

The following table describes the labels in this screen.

**Table 15** VoIP Setup Wizard > Registration Complete (Success)

LABEL	DESCRIPTION
Return to Wizard Main Page	Click this to open the main wizard screen. See <a href="#">Section 3.1 on page 47</a> .
Go to Advanced Setup page	Click this to close this screen and return to the main screen.
Finish	Click this to close this screen and return to the main screen.

If the ZyXEL Device cannot register your SIP account(s), see the Quick Start Guide for troubleshooting suggestions.

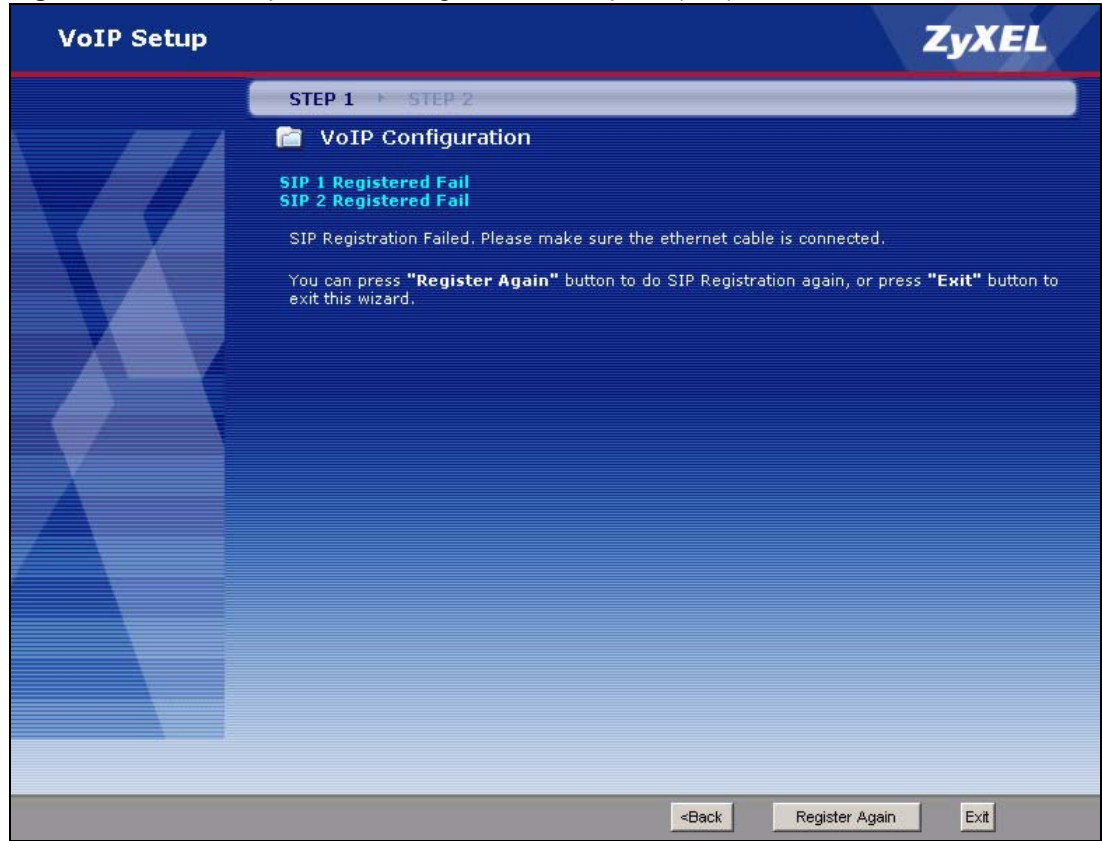
**Figure 24** VoIP Setup Wizard > Registration Complete (Fail)

The following table describes the labels in this screen.

**Table 16** VoIP Setup Wizard > Registration Complete (Fail)

LABEL	DESCRIPTION
< Back	Click this to go to the previous screen.
Register Again	Click this if you want the ZyXEL Device to try to register your SIP account(s) again.
Exit	Click this to close this screen and return to the main screen. The ZyXEL Device saves the information you provided.

### 3.4 Bandwidth Management Wizard

Use this wizard to control how much traffic can pass through your ZyXEL Device and the priority of each service (application) that can use it. Each service you select is guaranteed a small amount of bandwidth. The remaining bandwidth is divided by priority. If one service has higher priority than another, then the first service uses as much of the remaining bandwidth as it needs. If there is no more bandwidth for the second service, then it waits. If you do not select a service in this wizard (or if you do not find a particular service), the service can still use bandwidth, but it does not have any guaranteed amount and it has the lowest priority. See [Chapter 17 on page 197](#) for more information.

### 3.4.1 Welcome

**Figure 25** Bandwidth Management Wizard > Welcome

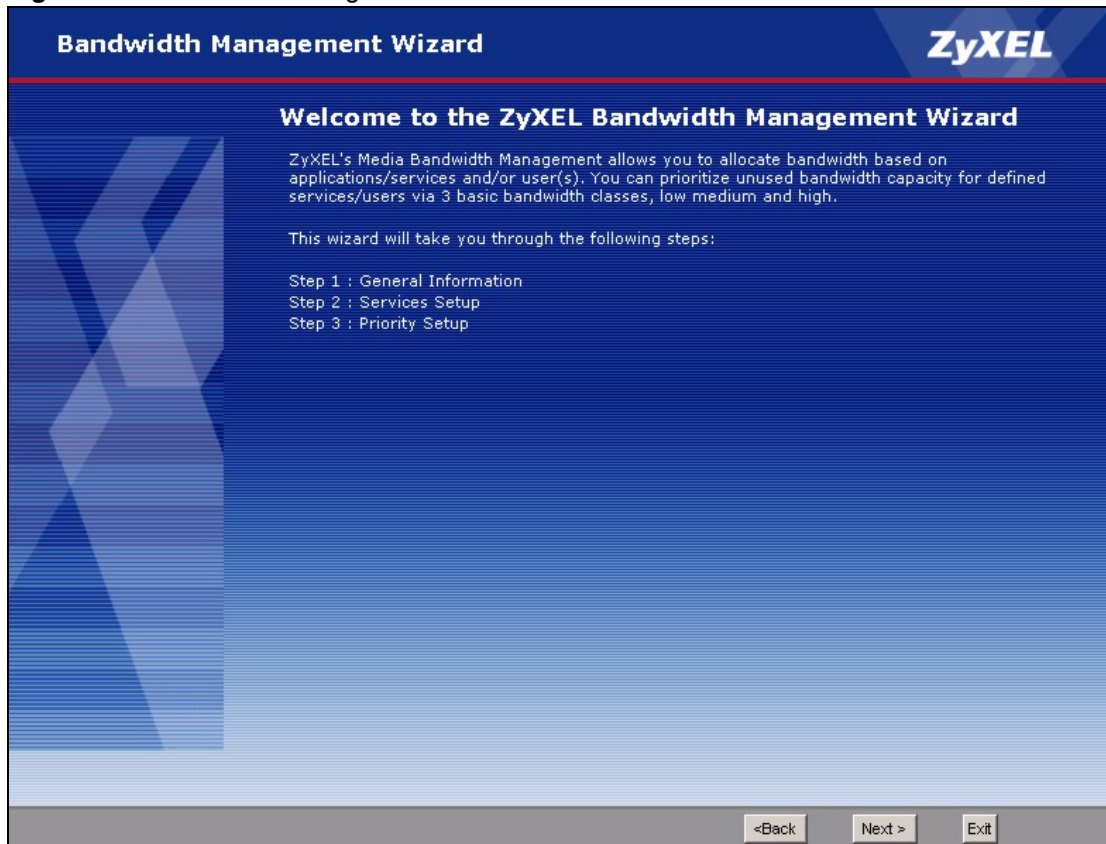

The following table describes the labels in this screen.

**Table 17** Bandwidth Management Wizard > Welcome

LABEL	DESCRIPTION
< Back	Click this to go to the previous screen.
Next >	Click this to go to the next screen.
Exit	Click this to close this screen and return to the main screen.

### 3.4.2 General Information

Figure 26 Bandwidth Management Wizard > General Information

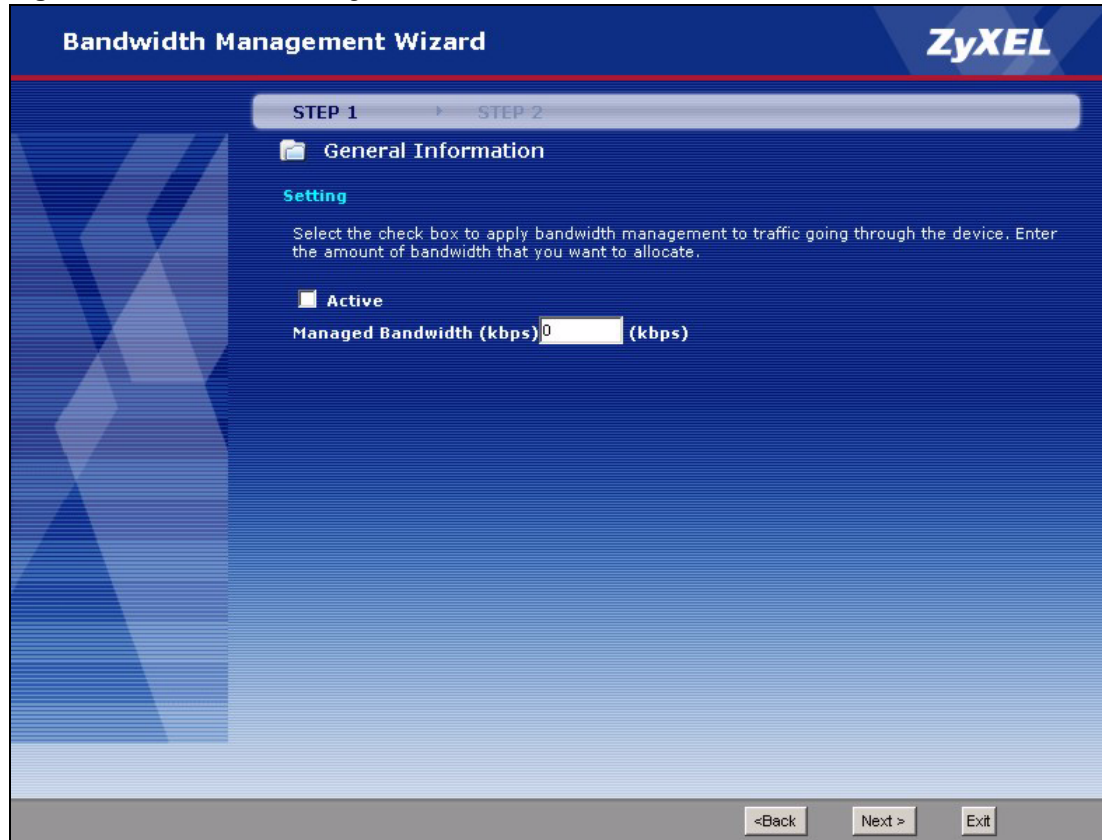

The following table describes the labels in this screen.

Table 18 Bandwidth Management Wizard > General Information

LABEL	DESCRIPTION
Active	Select this to enable bandwidth management. Bandwidth management applies to all traffic flowing through the router.
Managed Bandwidth (kbps)	Enter the total amount of traffic the device can send to the WAN. It is recommended to set this speed to what the device connected to the WAN can handle. For example, set this field to 1000 kbps if a broadband device connected to the WAN port has a maximum speed of 1000 kbps. This does not affect the total amount of traffic the device can send to the LAN. See <b>Management &gt; Bandwidth MGMT &gt; Summary</b> to do this.
< Back	Click this to go to the previous screen.
Next >	Click this to go to the next screen.
Exit	Click this to close this screen and return to the main screen.

### 3.4.3 Services Setup

Figure 27 Bandwidth Management Wizard > Services Setup

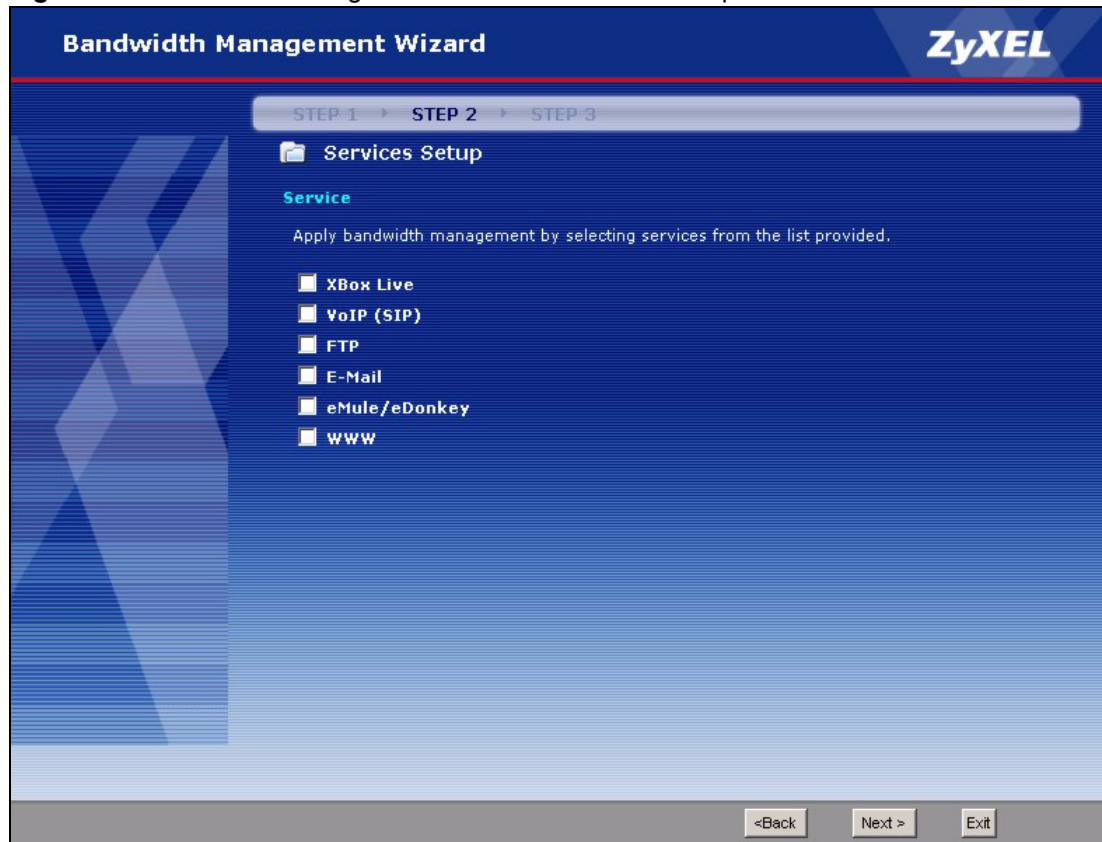

The following table describes the labels in this screen.

Table 19 Bandwidth Management Wizard > Services Setup

LABEL	DESCRIPTION
Service	<p>Select the service(s) that should have higher priority when bandwidth is allocated. If you do not select a service or if you do not see it in the list, the service can still use bandwidth. However, it has the lowest priority.</p> <p><b>Note: You must select at least one service in this screen.</b></p> <p>Each service you select (except WWW) becomes a LAN sub-class and a WAN sub-class in <a href="#">Management &gt; Bandwidth MGMT &gt; Class Setup</a>. If you select <b>WWW</b>, it only becomes a LAN sub-class.</p>
< Back	Click this to go to the previous screen.
Next >	Click this to go to the next screen.
Exit	Click this to close this screen and return to the main screen.

### 3.4.4 Priority Setup

Figure 28 Bandwidth Management Wizard > Priority Setup

**Bandwidth Management Wizard** **ZyXEL**

STEP 1    STEP 2

**General Information**

**Priority**

Set bandwidth priorities for the services listed.

Select "High", "Mid" or "Low" to prioritize the bandwidth for each service.  
If the rules set up in this wizard are changed in the ADVANCED setup, then the service priority will be set to "Other".

Service	Priority			
VoIP (SIP)	<input type="radio"/> High	<input type="radio"/> Mid	<input checked="" type="radio"/> Low	<input type="radio"/> Others
FTP	<input type="radio"/> High	<input type="radio"/> Mid	<input checked="" type="radio"/> Low	<input type="radio"/> Others
E-Mail	<input type="radio"/> High	<input type="radio"/> Mid	<input checked="" type="radio"/> Low	<input type="radio"/> Others
WWW	<input type="radio"/> High	<input type="radio"/> Mid	<input checked="" type="radio"/> Low	<input type="radio"/> Others

<Back    Apply    Exit

The following table describes the labels in this screen.

**Table 20** Bandwidth Management Wizard > Priority Setup

LABEL	DESCRIPTION
Service	This column displays each service you selected in the previous screen.
Priority	Set the priority of each service. If a service has higher priority than other services, then it can use as much remaining bandwidth as it needs. If there is no more bandwidth left, other services have to wait. Select <b>Others</b> only if you want to set up the sub-class manually in the <a href="#">Bandwidth Class Edit Screen</a> .
< Back	Click this to go to the previous screen.
Next >	Click this to go to the next screen.
Exit	Click this to close this screen and return to the main screen.



### 3.4.5 Finish

**Figure 29** Bandwidth Management Wizard > Finish

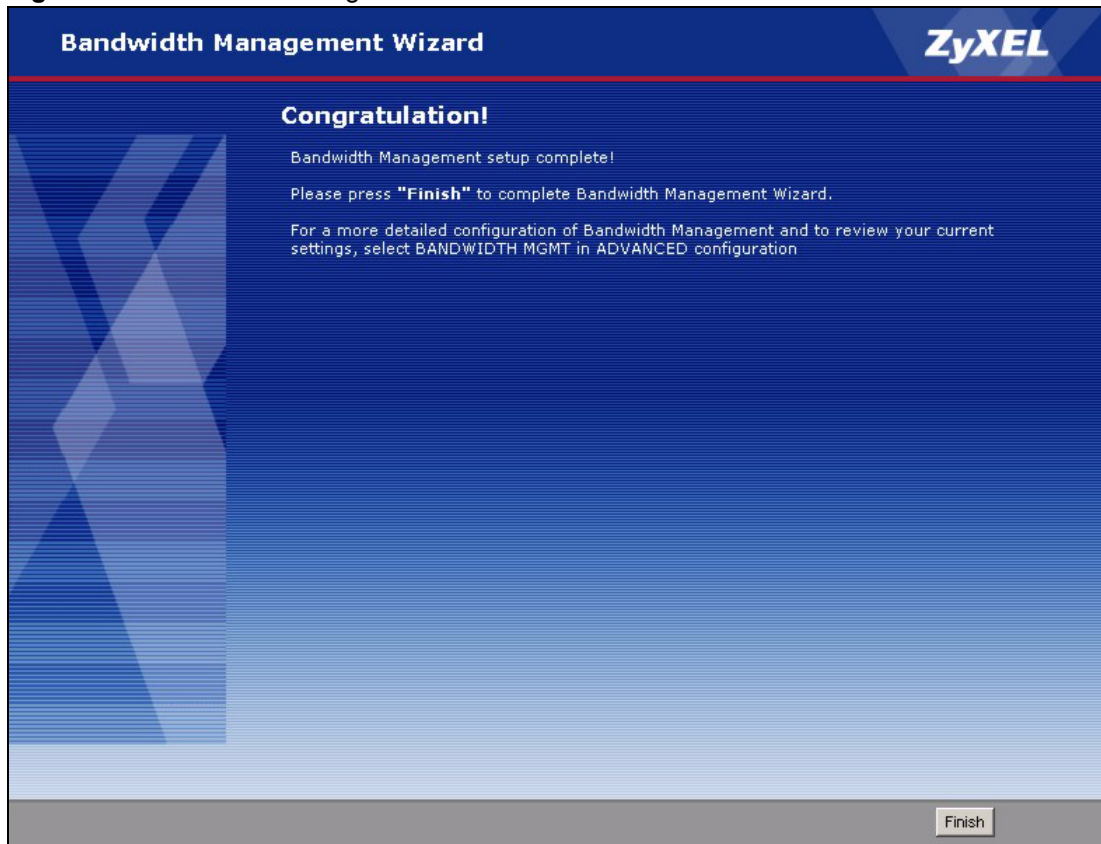

The following table describes the labels in this screen.

**Table 21** Bandwidth Management Wizard > Finish

LABEL	DESCRIPTION
Finish	Click this to close this screen and return to the main screen.



# Status Screens

Use the **Status** screens to look at the current status of the device, system resources, interfaces (LAN and WAN), and SIP accounts. You can also register and unregister SIP accounts. The **Status** screen also provides detailed information from Any IP and DHCP and statistics from VoIP, bandwidth management, and traffic.

## 4.1 Status Screen

Use this screen to look at the current status of the device, system resources, interfaces (LAN and WAN), and SIP accounts. You can also register and unregister SIP accounts.

Click **Status** to open this screen.

Figure 30 Status Screen

The screenshot displays the ZyXEL Status Screen with the following sections:

- Refresh Interval:** None (dropdown menu) and Refresh Now button.
- Device Information:**
  - System Name: P2302HWLP1
  - Firmware Version: V3.60(AJB.0)b4 | 04/10/2006
  - WAN Information:
    - IP Address: 172.23.23.132
    - IP Subnet Mask: 255.255.255.0
    - DHCP: Client
  - LAN Information:
    - IP Address: 192.168.1.1
    - IP Subnet Mask: 255.255.255.0
    - DHCP: Server
  - WLAN Information:
    - Name(SSID): ZyXEL
    - Channel: 6
    - Security Mode: No Security
- System Status:**
  - System Up Time: 6:13:02
  - Current Date/Time: 2000-01-01/06:23:39
  - System Resource:
    - CPU Usage: 1.76%
    - Memory Usage: 44%
    - IVR Usage: 1% of 127 Sec.
- Interface Status:**

Interface	Status	Rate
WAN	Up	100M/Full
LAN	Up	100M/Full
WLAN	Up	54M
- Summary:**
  - Any IP Table ([Details...](#))
  - DHCP Table ([Details...](#))
  - VoIP Statistics ([Details...](#))
  - BW MGMT Monitor ([Details...](#))
  - Packet Statistics ([Details...](#))
- VoIP Status:**

Account	Registration	URI
SIP 1	<input type="button" value="Register"/> Not Register	changeme@127.0.0.1
SIP 2	<input type="button" value="Register"/> Inactive	changeme@127.0.0.1

Each field is described in the following table.

Table 22 Status Screen

LABEL	DESCRIPTION
Refresh Interval	Enter how often you want the ZyXEL Device to update this screen.
Refresh Now	Click this to update this screen immediately.
Device Information	
System Name	This field displays the ZyXEL Device system name. It is used for identification. You can change this in the <b>Configuration Wizard</b> or <b>Maintenance &gt; System &gt; General</b> screen.
Firmware Version	This field displays the current version of the firmware inside the ZyXEL Device. It also shows the date the firmware version was created. You can change the firmware version by uploading new firmware in <b>Maintenance &gt; Tools &gt; Firmware</b> .
WAN Information	
IP Address	This field displays the current IP address of the ZyXEL Device in the WAN.
IP Subnet Mask	This field displays the current subnet mask in the WAN.

Table 22 Status Screen

LABEL	DESCRIPTION
DHCP	This field displays what DHCP services the ZyXEL Device is using in the WAN. Choices are: <b>Client</b> - The ZyXEL Device is a DHCP client in the WAN. Its IP address comes from a DHCP server on the WAN. <b>None</b> - The ZyXEL Device is not using any DHCP services in the WAN. It has a static IP address. If you are not using Roadrunner on Ethernet, you can change this in <b>Network &gt; WAN</b> . If you are using Roadrunner on Ethernet, this is controlled by Roadrunner.
LAN Information	
IP Address	This field displays the current IP address of the ZyXEL Device in the LAN.
IP Subnet Mask	This field displays the current subnet mask in the LAN.
DHCP	This field displays what DHCP services the ZyXEL Device is providing to the LAN. Choices are: <b>Server</b> - The ZyXEL Device is a DHCP server in the LAN. It assigns IP addresses to other computers in the LAN. <b>None</b> - The ZyXEL Device is not providing any DHCP services to the WAN. You can change this in <b>Network &gt; LAN &gt; DHCP Setup</b> .
WLAN Information	
SSID	This is the descriptive name used to identify the ZyXEL Device in the wireless LAN. Click this to go to the screen where you can change it.
Channel	This is the channel number used by the ZyXEL Device now.
Security Mode	This displays the security mode currently being used on the wireless network.
System Status	
System Up Time	This field displays how long the ZyXEL Device has been running since it last started up. The ZyXEL Device starts up when you plug it in, when you restart it ( <b>Maintenance &gt; Tools &gt; Restart</b> ), or when you reset it (see <a href="#">Section 2.3 on page 41</a> ).
Current Date/ Time	This field displays the current date and time in the ZyXEL Device. You can change this in <b>Maintenance &gt; System &gt; Time Setting</b> .
System Resource	
CPU Usage	This field displays what percentage of the ZyXEL Device's processing ability is currently used. When this percentage is close to 100%, the ZyXEL Device is running at full load, and the throughput is not going to improve anymore. If you want some applications to have more throughput, you should turn off other applications (for example, using bandwidth management; see <a href="#">Chapter 17 on page 197</a> ).
Memory Usage	This field displays what percentage of the ZyXEL Device's memory is currently used. Usually, this percentage should not increase much. If memory usage does get close to 100%, the ZyXEL Device is probably becoming unstable, and you should restart the device. See <a href="#">Section 24.2.5 on page 277</a> , or turn off the device (unplug the power) for a few seconds.
IVR Usage	This field displays what percentage of the ZyXEL Device's Interactive Voice Response (IVR) memory is currently used. This memory is used to store recordings of custom tones that the ZyXEL Device plays when people call you. See <a href="#">Section 9.2 on page 132</a> for more information.
Interface Status	
Interface	This column displays each interface the ZyXEL Device has.

**Table 22** Status Screen

LABEL	DESCRIPTION
Status	This field indicates whether or not the ZyXEL Device is using the interface. <b>Up</b> - The ZyXEL Device is using the interface. <b>Down</b> - The ZyXEL Device is not using the interface.
Rate	If the interface uses Ethernet encapsulation, this column displays the port speed and the Ethernet duplex setting. Duplex settings are: <b>Full</b> - The ZyXEL Device is using full-duplex Ethernet. <b>Half</b> - The ZyXEL Device is using half-duplex Ethernet. You cannot change the Ethernet duplex setting in the ZyXEL Device. If this interface uses PPPoE encapsulation, this column displays the port speed and the status of the call. <b>Down</b> - The connection is not available. <b>Dial</b> - The ZyXEL Device is making a call. <b>Idle</b> - The call is connected. <b>Drop</b> - The ZyXEL Device is ending the call. The LAN interface always uses Ethernet encapsulation. You can change the encapsulation of the WAN interface in <b>Network &gt; WAN &gt; Internet Connection</b> . For the WLAN interface this field displays the transmission rate of the ZyXEL Device.
Summary	
Any IP Table	Click ( <b>Details ...</b> ) to open the <b>Any IP Table</b> window. See <a href="#">Section 4.2 on page 71</a> .
DHCP Table	Click ( <b>Details ...</b> ) to open the <b>DHCP Table</b> window. See <a href="#">Section 4.3 on page 71</a> .
VoIP Statistics	Click ( <b>Details ...</b> ) to open the <b>VoIP Statistics</b> window. See <a href="#">Section 4.4 on page 72</a> .
BW MGMT Monitor	Click ( <b>Details ...</b> ) to open the <b>BW MGMT Monitor</b> window. See <a href="#">Section 4.5 on page 73</a> .
Packet Statistics	Click ( <b>Details ...</b> ) to open the <b>Packet Statistics</b> window. See <a href="#">Section 4.6 on page 75</a> .
VoIP Status	
Account	This column displays each SIP account in the ZyXEL Device.
Registration	This field displays the current registration status of the SIP account. You have to register SIP accounts with a SIP server to use VoIP. If the SIP account is already registered with the SIP server, <ul style="list-style-type: none"> <li>• Click <b>Unregister</b> to delete the SIP account's registration in the SIP server. This does not cancel your SIP account, but it deletes the mapping between your SIP identity and your IP address or domain name.</li> <li>• The second field displays <b>Registered</b>.</li> </ul> If the SIP account is not registered with the SIP server, <ul style="list-style-type: none"> <li>• Click <b>Register</b> to have the ZyXEL Device attempt to register the SIP account with the SIP server.</li> <li>• The second field displays the reason the account is not registered.</li> </ul> <b>Inactive</b> - The SIP account is not active. You can activate it in <b>VoIP &gt; SIP &gt; SIP Settings</b> . <b>Not Register</b> - The SIP account is active, but you have not tried to register it yet. <b>Register Fail</b> - The last time the ZyXEL Device tried to register the SIP account with the SIP server, the attempt failed.
URI	This field displays the account number and service domain of the SIP account. You can change these in <b>VoIP &gt; SIP &gt; SIP Settings</b> .

## 4.2 Any IP Table Window

To access this screen, open the **Status** screen (see [Section 4.1 on page 67](#)), and click **(Details ...)** next to **Any IP Table**.

**Figure 31** Any IP Table Window

#	IP Address	MAC Address
Refresh		

Each field is described in the following table.

**Table 23** Any IP Table Window

LABEL	DESCRIPTION
#	This field is a sequential value. It is not associated with a specific entry.
IP Address	This field displays the IP address of each computer that is using the ZyXEL Device but is in a different subnet than the ZyXEL Device.
MAC Address	This field displays the MAC address of the computer that is using the ZyXEL Device but is in a different subnet than the ZyXEL Device.
Refresh	Click this to update this screen.

## 4.3 DHCP Table Window

To access this screen, open the **Status** screen (see [Section 4.1 on page 67](#)), and click **(Details ...)** next to **DHCP Table**.

**Figure 32** DHCP Table Window

#	IP Address	Host Name	MAC Address
1	192.168.1.33	tw11477-02	00:50:8d:48:59:1f
Refresh			

Each field is described in the following table.

**Table 24** DHCP Table Window

LABEL	DESCRIPTION
#	This field is a sequential value. It is not associated with a specific entry.
IP Address	This field displays the IP address the ZyXEL Device assigned to a computer in the network.
Host Name	This field displays the system name of the computer to which the ZyXEL Device assigned the IP address.

**Table 24** DHCP Table Window

LABEL	DESCRIPTION
MAC Address	This field displays the MAC address of the computer to which the ZyXEL Device assigned the IP address.
Refresh	Click this to update this screen.

## 4.4 VoIP Statistics Window

To access this screen, open the **Status** screen (see [Section 4.1 on page 67](#)), and click **(Details ...)** next to **VoIP Statistics**.

**Figure 33** VoIP Statistics Window

The screenshot shows the VoIP Statistics Window with two main sections: SIP Status and Call Statistics. At the bottom, there is a control panel for the poll interval.

SIP Status:							
Account	Registration	Last Registration	URI	Protocol	Message Waiting	Last Incoming Number	Last Outgoing Number
SIP1	Register Fail	N/A	changeme@127.0.0.1	UDP	No	N/A	N/A
SIP2	Inactive	N/A	changeme@127.0.0.1	UDP	No	N/A	N/A

Call Statistics:									
Phone	Hook	Status	Codec	Peer Number	Duration	TxPkts	RxPkts	Tx B/s	Rx B/s
Phone1	On	N/A	N/A	N/A	0:00:00	0	0	0	0
Phone2	On	N/A	N/A	N/A	0:00:00	0	0	0	0

At the bottom of the window, there is a control panel with the following elements:

- Poll Interval:  sec
- Set Interval button
- Stop button

Each field is described in the following table.

**Table 25** VoIP Statistics Window

LABEL	DESCRIPTION
SIP Status	
Account	This column displays each SIP account in the ZyXEL Device.
Registration	This field displays the current registration status of the SIP account. You can change this in the <b>Status</b> screen. <b>Registered</b> - The SIP account is registered with a SIP server. <b>Register Fail</b> - The last time the ZyXEL Device tried to register the SIP account with the SIP server, the attempt failed. The ZyXEL Device automatically tries to register the SIP account when you turn on the ZyXEL Device or when you activate it. <b>Inactive</b> - The SIP account is not active. You can activate it in <b>VoIP &gt; SIP &gt; SIP Settings</b> .
Last Registration	This field displays the last time you successfully registered the SIP account. It displays <b>N/A</b> if you never successfully registered this account.
URI	This field displays the account number and service domain of the SIP account. You can change these in <b>VoIP &gt; SIP &gt; SIP Settings</b> .

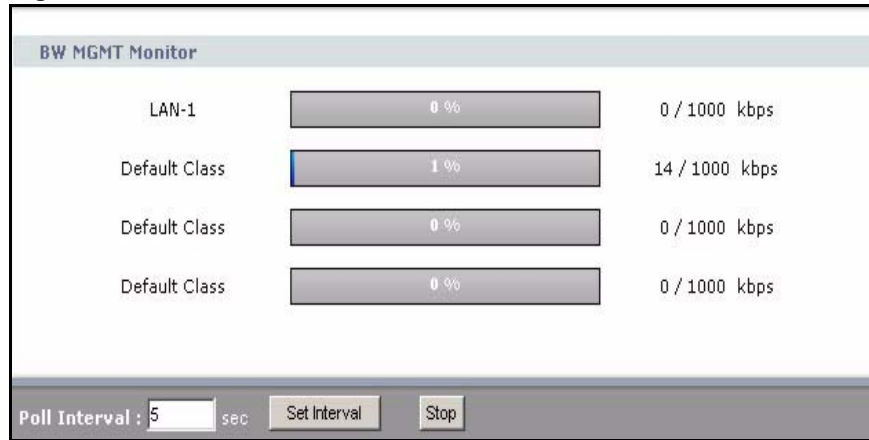

**Table 25** VoIP Statistics Window

LABEL	DESCRIPTION
Protocol	This field displays the transport protocol the SIP account is currently using.
Message Waiting	This field indicates whether or not there are any messages waiting for the SIP account.
Last Incoming Number	This field displays the last number that called the SIP account. It displays <b>N/A</b> if no number has ever dialed the SIP account.
Last Outgoing Number	This field displays the last number the SIP account called. It displays <b>N/A</b> if the SIP account has never dialed a number.
Call Statistics	
Phone	This field displays each phone port in the ZyXEL Device.
Hook	This field indicates whether the phone is on the hook or off the hook. <b>On</b> - The phone is hanging up or already hung up. <b>Off</b> - The phone is dialing, calling, or connected.
Status	This field displays the current status of each call. <b>DIAL</b> - The ZyXEL Device is dialing the current call. <b>RING</b> - The phone is ringing because there is an incoming call. <b>Process</b> - The call is connected and in process. <b>DROP</b> - The ZyXEL Device is hanging up (disconnecting) the current call. <b>DISC</b> - The ZyXEL Device has hung up. <b>N/A</b> - There is no phone connected to this phone port.
Codec	This field displays the type of voice compression used in the current call.
Peer Number	If the current call is a peer-to-peer call, this field displays the SIP number of the other party. Otherwise, it displays <b>N/A</b> .
Duration	This field displays how long the current call has lasted.
Tx Pkts	This field displays the number of packets the ZyXEL Device has transmitted in the current call.
Rx Pkts	This field displays the number of packets the ZyXEL Device has received in the current call.
Tx B/s	This field displays how quickly the ZyXEL Device has transmitted packets in the current call. The rate is the number of kilobits transmitted one second before the last time the screen updated (refreshed).
Rx B/s	This field displays how quickly the ZyXEL Device has received packets in the current call. The rate is the number of kilobits received one second before the last time the screen updated (refreshed).
Poll Interval	Enter how often you want the ZyXEL Device to update this screen, and click <b>Set Interval</b> .
Set Interval	Click this to make the ZyXEL Device update the screen based on the amount of time you specified in <b>Poll Interval</b> .
Stop	Click this to make the ZyXEL Device stop updating the screen.

## 4.5 BW MGMT Monitor Window

To access this screen, open the **Status** screen (see [Section 4.1 on page 67](#)), and click (**Details ...**) next to **BW MGMT Monitor**.

**Figure 34** BW MGMT Monitor Window

The types of traffic shown in this screen do not depend on your settings in the [Bandwidth Management Wizard](#) or in [Bandwidth MGMT](#). Each field is described in the following table.

**Table 26** BW MGMT Monitor Window

LABEL	DESCRIPTION
LAN-VoIP (SIP)	This field displays how much SIP traffic is going to the LAN each second. The rate is the number of kilobits that went to the LAN one second before the last time the screen updated (refreshed).
LAN-FTP	This field displays how much FTP traffic is going to the LAN each second. The rate is the number of kilobits that went to the LAN one second before the last time the screen updated (refreshed).
LAN-E-Mail	This field displays how much e-mail went to the LAN each second. The rate is the number of kilobits that went to the LAN one second before the last time the screen updated (refreshed).
LAN-WWW	This field displays how much web traffic went to the LAN each second. The rate is the number of kilobits that went to the LAN one second before the last time the screen updated (refreshed).
Default Class	This field displays how much traffic that is not allocated to any sub-class went to the LAN each second. The rate is the number of kilobits that went to the LAN one second before the last time the screen updated (refreshed). This might include SIP traffic, FTP traffic, e-mail, or web traffic, depending on what traffic is allocated to sub-classes. You can change what traffic is allocated to sub-classes in <b>Management &gt; Bandwidth MGMT &gt; Class Setup</b> .
WAN-VoIP (SIP)	This field displays how much SIP traffic went to the WAN each second. The rate is the number of kilobits that went to the WAN one second before the last time the screen updated (refreshed).
WAN-FTP	This field displays how much FTP traffic went to the WAN each second. The rate is the number of kilobits that went to the WAN one second before the last time the screen updated (refreshed).
WAN-E-Mail	This field displays how much e-mail went to the WAN each second. The rate is the number of kilobits that went to the WAN one second before the last time the screen updated (refreshed).
Default Class	This field displays how much traffic that is not allocated to any sub-class went to the WAN each second. The rate is the number of kilobits that went to the WAN one second before the last time the screen updated (refreshed). This might include SIP traffic, FTP traffic, e-mail, or web traffic, depending on what traffic is allocated to sub-classes. You can change what traffic is allocated to sub-classes in <b>Management &gt; Bandwidth MGMT &gt; Class Setup</b> .

**Table 26** BW MGMT Monitor Window

LABEL	DESCRIPTION
Poll Interval	Enter how often you want the ZyXEL Device to update this screen, and click <b>Set Interval</b> .
Set Interval	Click this to make the ZyXEL Device update the screen based on the amount of time you specified in <b>Poll Interval</b> .
Stop	Click this to make the ZyXEL Device stop updating the screen.

## 4.6 Packet Statistics Window

To access this screen, open the **Status** screen (see [Section 4.1 on page 67](#)), and click (**Details ...**) next to **Packet Statistics**.

**Figure 35** Packet Statistics Window

Port	Status	TxPkts	RxPkts	Collisions	Tx B/s	Rx B/s	Up Time
WAN	100M/Full	97752	117933	0	0	621	6:37:47
LAN	100M/Full	78704	100296	0	0	0	2:07:46
WLAN	54M	2158	1877	0	0	0	6:37:48

System Up Time : 6:37:53

Poll Interval : 5 sec    Set Interval    Stop

Each field is described in the following table.

**Table 27** Packet Statistics Window

LABEL	DESCRIPTION
Port	This field displays each port in the ZyXEL Device.
Status	<p>If the port is not connected to anything, this field displays <b>Down</b>.</p> <p>If the interface uses Ethernet encapsulation, this field displays the port speed and the Ethernet duplex setting. Duplex settings are:</p> <p><b>Full</b> - The ZyXEL Device is using full-duplex Ethernet.</p> <p><b>Half</b> - The ZyXEL Device is using half-duplex Ethernet.</p> <p>You cannot change the Ethernet duplex setting in the ZyXEL Device.</p> <p>If this interface uses PPPoE encapsulation, this field displays the port speed and the status of the call.</p> <p><b>Down</b> - The connection is not available.</p> <p><b>Dial</b> - The ZyXEL Device is making the call.</p> <p><b>Idle</b> - The call is connected.</p> <p><b>Drop</b> - The ZyXEL Device is ending the call.</p> <p>The LAN interface always uses Ethernet encapsulation. You can change the encapsulation of the WAN interface in <b>Network &gt; WAN &gt; Internet Connection</b>.</p>
Tx Pkts	This field displays the number of packets the ZyXEL Device has transmitted from the port.

**Table 27** Packet Statistics Window

<b>LABEL</b>	<b>DESCRIPTION</b>
Rx Pkts	This field displays the number of packets the ZyXEL Device has received from the port.
Collisions	This field displays the number of collisions detected by the port.
Tx B/s	This field displays how quickly the ZyXEL Device has transmitted packets from the port. The rate is the number of bytes transmitted one second before the last time the screen updated (refreshed).
Rx B/s	This field displays how quickly the ZyXEL Device has received packets from the port. The rate is the number of bytes received one second before the last time the screen updated (refreshed).
Up Time	This is the total amount of time the port has been connected.
System Up Time	This field displays how long the ZyXEL Device has been running since it last started up. The ZyXEL Device starts up when you plug it in, when you restart it ( <b>Maintenance &gt; Tools &gt; Restart</b> ), or when you reset it (see <a href="#">Section 2.3 on page 41</a> ).
Poll Interval	Enter how often you want the ZyXEL Device to update this screen, and click <b>Set Interval</b> .
Set Interval	Click this to make the ZyXEL Device update the screen based on the amount of time you specified in <b>Poll Interval</b> .
Stop	Click this to make the ZyXEL Device stop updating the screen.

---

# PART II

# Network

---

Wireless LAN (79)

WAN (95)

LAN (105)

NAT (117)



# Wireless LAN

This chapter discusses how to configure the wireless network settings in your ZyXEL Device. See the appendices for more detailed information about wireless networks.

## 5.1 Wireless Network Overview

The following figure provides an example of a wireless network.

**Figure 36** Example of a Wireless Network

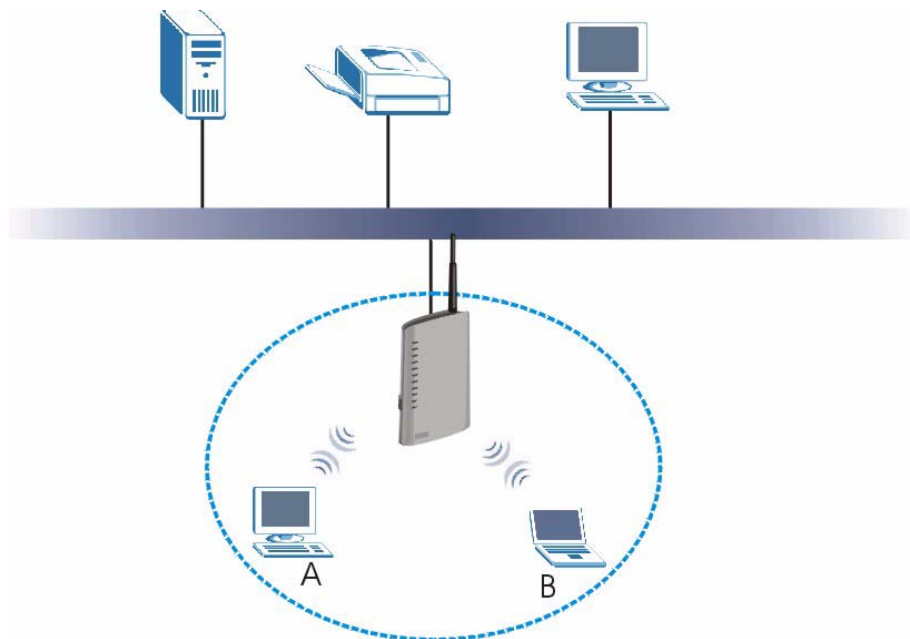

The wireless network is the part in the blue circle. In this wireless network, devices **A** and **B** use the access point (**AP**) to interact with the other devices (such as the printer) or with the Internet. Your ZyXEL Device is the AP.

Every wireless network must follow these basic guidelines.

- Every device in the same wireless network must use the same SSID. The SSID is the name of the wireless network. It stands for Service Set Identity.
- If two wireless networks overlap, they should use a different channel. Like radio stations or television channels, each wireless network uses a specific channel, or frequency, to send and receive information.

- Every device in the same wireless network must use security compatible with the AP. Security stops unauthorized devices from using the wireless network. It can also protect the information that is sent in the wireless network.

## 5.2 Wireless Security Overview

The following sections introduce different types of wireless security you can set up in the wireless network.

### 5.2.1 SSID

Normally, the ZyXEL Device acts like a beacon and regularly broadcasts the SSID in the area. You can hide the SSID instead, in which case the ZyXEL Device does not broadcast the SSID. In addition, you should change the default SSID to something that is difficult to guess.

This type of security is fairly weak, however, because there are ways for unauthorized wireless devices to get the SSID. In addition, unauthorized wireless devices can still see the information that is sent in the wireless network.

### 5.2.2 MAC Address Filter

Every device that can use a wireless network has a unique identification number, called a MAC address.<sup>1</sup> A MAC address is usually written using twelve hexadecimal characters<sup>2</sup>; for example, 00A0C5000002 or 00:A0:C5:00:00:02. To get the MAC address for each device in the wireless network, see the device's User's Guide or other documentation.

You can use the MAC address filter to tell the ZyXEL Device which devices are allowed or not allowed to use the wireless network. If a device is allowed to use the wireless network, it still has to have the correct information (SSID, channel, and security). If a device is not allowed to use the wireless network, it does not matter if it has the correct information.

This type of security does not protect the information that is sent in the wireless network. Furthermore, there are ways for unauthorized wireless devices to get the MAC address of an authorized device. Then, they can use that MAC address to use the wireless network.

### 5.2.3 User Authentication

You can make every user log in to the wireless network before they can use it. This is called user authentication. However, every device in the wireless network has to support IEEE 802.1x to do this.

For wireless networks, user names and passwords for each user can be stored in a RADIUS server.

---

1. Some wireless devices, such as scanners, can detect wireless networks but cannot use wireless networks. These kinds of wireless devices might not have MAC addresses.

2. Hexadecimal characters are 0, 1, 2, 3, 4, 5, 6, 7, 8, 9, A, B, C, D, E, and F.



Unauthorized wireless devices can still see the information that is sent in the wireless network, even if they cannot use the wireless network. Furthermore, there are ways for unauthorized wireless users to get a valid user name and password. Then, they can use that user name and password to use the wireless network.

## 5.2.4 Encryption

Wireless networks can use encryption to protect the information that is sent in the wireless network. Encryption is like a secret code. If you do not know the secret code, you cannot understand the message.

The types of encryption you can choose depend on the type of authentication. (See [Section 5.2.3 on page 80](#) for information about this.)

**Table 28** Types of Encryption for Each Type of Authentication

	NO AUTHENTICATION	RADIUS SERVER
<b>Weakest</b>	None	
	<b>Static WEP</b>	
	<b>WPA-PSK</b>	<b>WPA</b>
<b>Strongest</b>	<b>WPA2-PSK</b>	<b>WPA2</b>

For example, if the wireless network has a RADIUS server, you can choose **WPA** or **WPA2**. If users do not log in to the wireless network, you can choose no encryption, **Static WEP**, **WPA-PSK**, or **WPA2-PSK**.

Usually, you should set up the strongest encryption that every device in the wireless network supports. For example, suppose you have a wireless network with the ZyXEL Device. The ZyXEL Device does not have a local user database, and you do not have a RADIUS server. Therefore, there is no authentication. Suppose the wireless network has two devices. Device A only supports WEP, and device B supports WEP and WPA. Therefore, you should set up **Static WEP** in the wireless network.



**It is recommended that wireless networks use WPA-PSK, WPA, or stronger encryption.**

When you select **WPA2** or **WPA2-PSK** in your ZyXEL Device, you can also select an option (**WPA compatible**) to support WPA as well. In this case, if some of the devices support WPA and some support WPA2, you should set up **WPA2-PSK** or **WPA2** (depending on the type of wireless network login) and select the **WPA compatible** option in the ZyXEL Device.

Many types of encryption use a key to protect the information in the wireless network. The longer the key, the stronger the encryption. Every device in the wireless network must have the same key.

### 5.2.5 One-Touch Intelligent Security Technology (OTIST)

With ZyXEL's OTIST, you set up the SSID and the encryption (WEP or WPA-PSK) on the ZyXEL Device. Then, the ZyXEL Device transfers them to the devices in the wireless networks. As a result, you do not have to set up the SSID and encryption on every device in the wireless network.

The devices in the wireless network have to support OTIST, and they have to be in range of the ZyXEL Device when you activate it. See [Section 5.5 on page 88](#) for more details.

## 5.3 Additional Wireless Terms

The following table describes wireless network terms and acronyms used in the ZyXEL Device.

**Table 29** Additional Wireless Terms

TERM	DESCRIPTION
RTS/CTS Threshold	In a wireless network which covers a large area, wireless devices are sometimes not aware of each other's presence. This may cause them to send information to the AP at the same time and result in information colliding and not getting through. By setting this value lower than the default value, the wireless devices must sometimes get permission to send information to the ZyXEL Device. The lower the value, the more often the devices must get permission. If this value is greater than the fragmentation threshold value (see below), then wireless devices never have to get permission to send information to the ZyXEL Device.
Authentication	The process of verifying whether a wireless device is allowed to use the wireless network.
Max. Frame Burst	Enable this to improve the performance of both pure IEEE 802.11g and mixed IEEE 802.11b/g networks. Maximum Frame Burst sets the maximum time that the ZyXEL Device transmits IEEE 802.11g wireless traffic only.
Fragmentation Threshold	A small fragmentation threshold is recommended for busy networks, while a larger threshold provides faster performance if the network is not very busy.

## 5.4 General WLAN Screen



**If you are configuring the ZyXEL Device from a computer connected to the wireless LAN and you change the ZyXEL Device's SSID or WEP settings, you will lose your wireless connection when you press Apply to confirm. You must then change the wireless settings of your computer to match the ZyXEL Device's new settings.**

Click **Network > Wireless LAN** to open the **Wireless LAN General** screen.

**Figure 37** Wireless LAN: General

The screenshot shows a configuration window for a wireless LAN. At the top, there are four tabs: 'General' (selected), 'DTIST', 'MAC Filter', and 'Advanced'. Below the tabs is a 'Wireless Setup' section with the following options:
 

- Enable Wireless LAN
- Name(SSID): ZyXEL
- Hide SSID
- Channel Selection: Channel-06 2437MHz

 Below this is a 'Security' section with:
 

- Security Mode: No Security

 At the bottom of the window are 'Apply' and 'Cancel' buttons.

The following table describes the general wireless LAN labels in this screen.

**Table 30** Wireless LAN: General

LABEL	DESCRIPTION
Enable Wireless LAN	Click the check box to activate wireless LAN.
Name(SSID)	<p>(Service Set IDentity) The SSID identifies the Service Set with which a wireless station is associated. Wireless stations associating to the access point (AP) must have the same SSID. Enter a descriptive name (up to 32 printable 7-bit ASCII characters) for the wireless LAN.</p> <p><b>Note: If you are configuring the ZyXEL Device from a computer connected to the wireless LAN and you change the ZyXEL Device's SSID or WEP settings, you will lose your wireless connection when you press Apply to confirm. You must then change the wireless settings of your computer to match the ZyXEL Device's new settings.</b></p>
Hide SSID	Select this check box to hide the SSID in the outgoing beacon frame so a station cannot obtain the SSID through scanning using a site survey tool.
Channel Selection	<p>If two wireless networks overlap, they should use a different channel. Like radio stations or television channels, each wireless network uses a specific channel, or frequency, to send and receive information. Select a channel from the drop-down list box.</p>
Security Mode	See the following sections for more details about this field.
Apply	Click <b>Apply</b> to save your changes back to the ZyXEL Device.
Cancel	Click <b>Cancel</b> to reload the previous configuration for this screen.

### 5.4.1 No Security

Select **No Security** to allow wireless stations to communicate with the access points without any data encryption.



**If you do not enable any wireless security on your ZyXEL Device, your network is accessible to any wireless networking device that is within range.**

**Figure 38** Wireless: No Security

The screenshot shows the 'General' tab of the wireless configuration page. Under 'Wireless Setup', 'Enable Wireless LAN' is checked, 'Name(SSID)' is 'ZyXEL', 'Hide SSID' is unchecked, and 'Channel Selection' is 'Channel-06 2437MHz'. Under 'Security', 'Security Mode' is set to 'No Security'. 'Apply' and 'Cancel' buttons are at the bottom.

The following table describes the labels in this screen.

**Table 31** Wireless No Security

LABEL	DESCRIPTION
Security Mode	Choose <b>No Security</b> from the drop-down list box.

## 5.4.2 WEP Encryption Screen

In order to configure and enable WEP encryption; click **Network > Wireless LAN** to display the **General** screen. Select **Static WEP** from the **Security Mode** list.

**Figure 39** Wireless: Static WEP Encryption

The screenshot shows the 'Security' tab of the wireless configuration interface. The 'Security Mode' is set to 'Static WEP'. The 'Passphrase' field is empty, with a 'Generate' button next to it. The 'WEP Encryption' is set to '128-bit WEP' and the 'Authentication Method' is 'Auto'. Below these settings is a 'Note' section with the following text:

**Note:**  
**64-bit WEP:** Enter 5 ASCII characters or 10 hexadecimal characters ("0-9", "A-F") for each Key (1-4).  
**128-bit WEP:** Enter 13 ASCII characters or 26 hexadecimal characters ("0-9", "A-F") for each Key (1-4).  
**256-bit WEP:** Enter 29 ASCII characters or 58 hexadecimal characters ("0-9", "A-F") for each Key (1-4).  
 (Select one WEP key as an active key to encrypt wireless data transmission.)

Below the note, there are radio buttons for 'ASCII' (selected) and 'Hex'. There are four key input fields labeled 'Key 1', 'Key 2', 'Key 3', and 'Key 4'. At the bottom of the screen, there are 'Apply' and 'Cancel' buttons.

The following table describes the wireless LAN security labels in this screen.

**Table 32** Wireless: Static WEP Encryption

LABEL	DESCRIPTION
Security Mode	Choose <b>Static WEP</b> from the drop-down list box.
Passphrase	Enter a Passphrase (up to 32 printable characters) and clicking <b>Generate</b> . The ZyXEL Device automatically generates a WEP key.
WEP Encryption	Select <b>64-bit WEP</b> , <b>128-bit WEP</b> or <b>256-bit WEP</b> to specify data encryption.
Authentication Method	This field specifies whether the wireless clients have to provide the WEP key to login to the wireless client. Keep this setting at <b>Auto</b> or <b>Open System</b> unless you want to force a key verification before communication between the wireless client and the ZyXEL Device occurs. Select <b>Shared Key</b> to force the clients to provide the WEP key prior to communication.
Key 1 - Key 4	The WEP key is used to encrypt data. Both the ZyXEL Device and the wireless stations must use the same WEP key for data transmission. You can set 4 different keys and make one of the keys active at a time. If you want to manually set the WEP key, enter any 5, 13 or 29 characters (ASCII string) or 10, 26 or 58 hexadecimal characters ("0-9", "A-F") for a 64-bit, 128-bit or 256-bit WEP key respectively.

### 5.4.3 WPA(2)-PSK

In order to configure and enable WPA-PSK authentication; click **Network > Wireless LAN** to display the **General** screen. Select **WPA-PSK** or **WPA2-PSK** from the **Security Mode** list.

**Figure 40** Wireless: WPA(2)-PSK

The following table describes the wireless LAN security labels in this screen.

**Table 33** Wireless: WPA(2)-PSK

LABEL	DESCRIPTION
Security Mode	Choose <b>WPA-PSK</b> or <b>WPA2-PSK</b> from the drop-down list box.
WPA Compatible	This field is only available for WPA2-PSK. Select this if you want the ZyXEL Device to support WPA-PSK and WPA2-PSK simultaneously.
Pre-Shared Key	The encryption mechanisms used for <b>WPA(2)</b> and <b>WPA(2)-PSK</b> are the same. The only difference between the two is that <b>WPA(2)-PSK</b> uses a simple common password, instead of user-specific credentials. Type a pre-shared key from 8 to 63 case-sensitive ASCII characters (including spaces and symbols).
ReAuthentication Timer (in seconds)	Specify how often wireless stations have to resend usernames and passwords in order to stay connected. Enter a time interval between 10 and 9999 seconds. The default time interval is 1800 seconds (30 minutes).  <b>Note: If wireless station authentication is done using a RADIUS server, the reauthentication timer on the RADIUS server has priority.</b>
Idle Timeout	The ZyXEL Device automatically disconnects a wireless station from the wired network after a period of inactivity. The wireless station needs to enter the username and password again before access to the wired network is allowed. The default time interval is 3600 seconds (or 1 hour).
Group Key Update Timer	The <b>Group Key Update Timer</b> is the rate at which the AP (if using <b>WPA(2)-PSK</b> key management) or <b>RADIUS</b> server (if using WPA key management) sends a new group key out to all clients. The re-keying process is the WPA equivalent of automatically changing the WEP key for an AP and all stations in a WLAN on a periodic basis. Setting of the <b>Group Key Update Timer</b> is also supported in <b>WPA-PSK</b> mode. The ZyXEL Device default is <b>1800</b> seconds (30 minutes).

## 5.4.4 WPA(2) Authentication Screen

In order to configure and enable WPA Authentication; click the **Wireless LAN** link under **Network** to display the **Wireless** screen. Select **WPA** or **WPA2** from the **Security** list.

**Figure 41** Wireless: WPA(2)

The following table describes the wireless LAN security labels in this screen.

**Table 34** Wireless: WPA(2)

LABEL	DESCRIPTION
Security Mode	Choose <b>WPA</b> or <b>WPA2</b> from the drop-down list box.
WPA Compatible	This field is only available for WPA2. Select this if you want the ZyXEL Device to support WPA and WPA2 simultaneously.
ReAuthentication Timer (in seconds)	Specify how often wireless stations have to resend usernames and passwords in order to stay connected. Enter a time interval between 10 and 9999 seconds. The default time interval is 1800 seconds (30 minutes).  <b>Note: If wireless station authentication is done using a RADIUS server, the reauthentication timer on the RADIUS server has priority.</b>
Idle Timeout	The ZyXEL Device automatically disconnects a wireless station from the wired network after a period of inactivity. The wireless station needs to enter the username and password again before access to the wired network is allowed. The default time interval is 3600 seconds (or 1 hour).

**Table 34** Wireless: WPA(2)

LABEL	DESCRIPTION
Group Key Update Timer	The <b>Group Key Update Timer</b> is the rate at which the AP (if using <b>WPA-PSK</b> key management) or <b>RADIUS</b> server (if using WPA key management) sends a new group key out to all clients. The re-keying process is the WPA equivalent of automatically changing the WEP key for an AP and all stations in a WLAN on a periodic basis. Setting of the <b>Group Key Update Timer</b> is also supported in <b>WPA-PSK</b> mode. The ZyXEL Device default is <b>1800</b> seconds (30 minutes).
Authentication Server	
IP Address	Enter the IP address of the external authentication server in dotted decimal notation.
Port Number	Enter the port number of the external authentication server. The default port number is <b>1812</b> . You need not change this value unless your network administrator instructs you to do so with additional information.
Shared Secret	Enter a password (up to 31 alphanumeric characters) as the key to be shared between the external authentication server and the ZyXEL Device. The key must be the same on the external authentication server and your ZyXEL Device. The key is not sent over the network.
Accounting Server (optional)	
IP Address	Enter the IP address of the external accounting server in dotted decimal notation.
Port Number	Enter the port number of the external accounting server. The default port number is <b>1813</b> . You need not change this value unless your network administrator instructs you to do so with additional information.
Shared Secret	Enter a password (up to 31 alphanumeric characters) as the key to be shared between the external accounting server and the ZyXEL Device. The key must be the same on the external accounting server and your ZyXEL Device. The key is not sent over the network.

## 5.5 OTIST Screen

Use this screen to set up and start OTIST on the ZyXEL Device in your wireless network. To open this screen, click **Network > Wireless LAN > OTIST**.

**Figure 42** Network > Wireless LAN > OTIST

The screenshot shows the OTIST configuration interface. At the top, there are tabs for 'General', 'OTIST', 'MAC Filter', and 'Advanced'. The 'OTIST' tab is active. Below the tabs, the title 'One-Touch Intelligent Security Technology' is displayed. The 'Setup Key' field contains the value '01234567'. A checkbox labeled 'Yes!' is checked, and a message below it reads: 'Please enhance the Wireless Security Level to WPA-PSK automatically if no WLAN security has been set. This will generate a random PSK key for your convenience.' At the bottom center, there is a 'Start' button.



The following table describes the labels in this screen.

**Table 35** Network > Wireless LAN > OTIST

LABEL	DESCRIPTION
Setup Key	Type a key (password) 8 ASCII characters long.  <b>Note: If you change the OTIST setup key in the ZyXEL Device, you must change it on the wireless devices too.</b>
Yes!	Select this if you want the ZyXEL Device to automatically generate a pre-shared key for the wireless network. Before you do this, click <b>Network &gt; Wireless LAN &gt; General</b> and set the <b>Security Mode</b> to <b>No Security</b> . Clear this if you want the ZyXEL Device to use a pre-shared key that you enter. Before you do this, click <b>Network &gt; Wireless LAN &gt; General</b> , set the <b>Security Mode</b> to <b>WPA-PSK</b> , and enter the <b>Pre-Shared Key</b> .
Start	Click <b>Start</b> to activate OTIST and transfer settings. The process takes three minutes to complete.  <b>Note: You must click Start in the ZyXEL Device and in the wireless device(s) within three minutes of each other. You can start OTIST in the wireless devices and the ZyXEL Device in any order.</b>

Before you click **Start**, you should enable OTIST on all the OTIST-enabled devices in the wireless network. For most devices, follow these steps.

- 1 Start the ZyXEL utility
- 2 Click the **Adapter** tab.
- 3 Select the **OTIST** check box, and enter the same **Setup Key** as the ZyXEL Device.
- 4 Click **Save**.

**Figure 43** Example: Wireless Client OTIST Screen

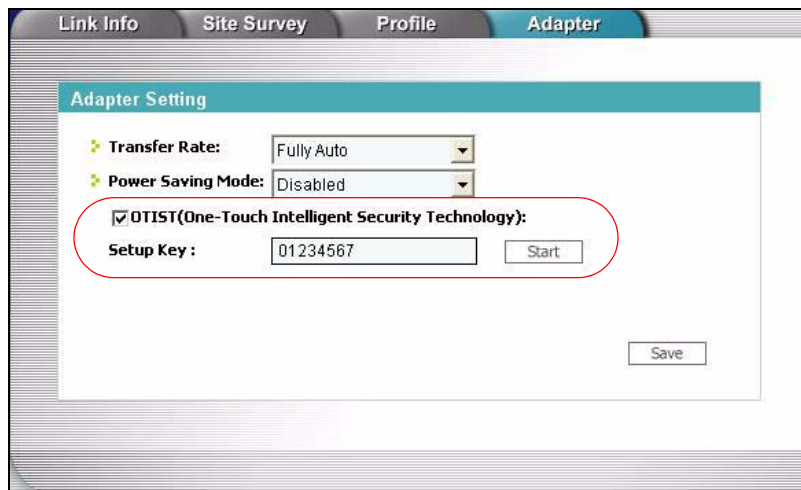

To start OTIST in the device, click **Start** in this screen.



**You must click **Start** in the ZyXEL Device and in the wireless device(s) within three minutes of each other. You can start OTIST in the wireless devices and the ZyXEL Device in any order.**

After you click **Start** in the ZyXEL Device, the following screen appears (in the ZyXEL Device).

**Figure 44** OTIST: Settings

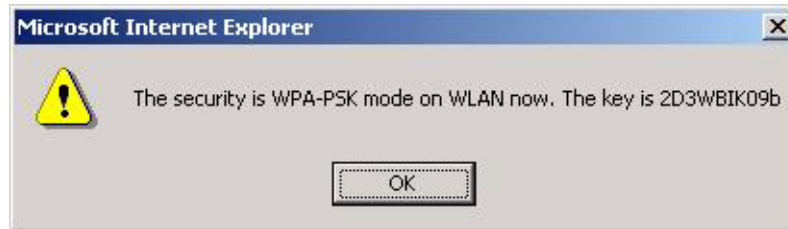

You can use the key in this screen to set up WPA-PSK encryption manually for non-OTIST devices in the wireless network.

Review the settings, and click **OK**. The ZyXEL Device begins transferring OTIST settings. The following is an example screen that appears in the wireless devices.

**Figure 45** OTIST: In Progress on the Wireless Device

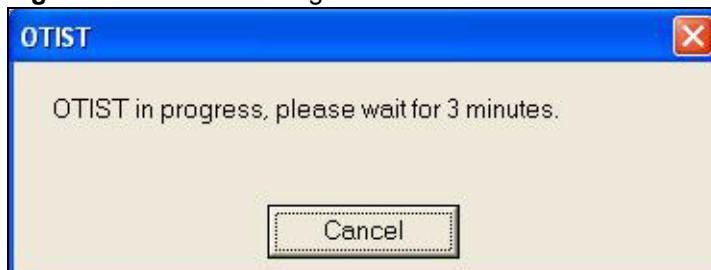

This screen closes when the transfer is complete.

### 5.5.1 Notes on OTIST

- 1 If you enable OTIST in a wireless device, you see this screen each time you start the utility. Click **Yes** to search for an OTIST-enabled AP (in other words, the ZyXEL Device).

**Figure 46** Start OTIST?

- 2 If an OTIST-enabled wireless device loses its wireless connection for more than ten seconds, it will search for an OTIST-enabled AP for up to one minute. (If you manually have the wireless device search for an OTIST-enabled AP, there is no timeout; click **Cancel** in the OTIST progress screen to stop the search.)
- 3 After the wireless device finds an OTIST-enabled AP, you must click **Start** in the ZyXEL Device's **Network > Wireless LAN > OTIST** screen or hold in the **Reset** button on the ZyXEL Device for one or two seconds to transfer the settings again.
- 4 If you change the SSID or the keys on the ZyXEL Devices after using OTIST, you need to run OTIST again or enter them manually in the wireless device(s).
- 5 If you configure OTIST to generate a WPA-PSK key, this key changes each time you run OTIST. Therefore, if a new wireless device joins your wireless network, you need to run OTIST on the AP and ALL wireless devices again.

## 5.6 MAC Filter

To change your ZyXEL Device's MAC filter settings, click **Network > Wireless LAN > MAC Filter**. The screen appears as shown.

**Figure 47** MAC Address Filter

General OTIIST **MAC Filter** Advanced

MAC Address Filter

Active

Filter Action  Allow  Deny

Set	MAC Address	Set	MAC Address
1	00:00:00:00:00:00	17	00:00:00:00:00:00
2	00:00:00:00:00:00	18	00:00:00:00:00:00
3	00:00:00:00:00:00	19	00:00:00:00:00:00
4	00:00:00:00:00:00	20	00:00:00:00:00:00
5	00:00:00:00:00:00	21	00:00:00:00:00:00
6	00:00:00:00:00:00	22	00:00:00:00:00:00
7	00:00:00:00:00:00	23	00:00:00:00:00:00
8	00:00:00:00:00:00	24	00:00:00:00:00:00
9	00:00:00:00:00:00	25	00:00:00:00:00:00
10	00:00:00:00:00:00	26	00:00:00:00:00:00
11	00:00:00:00:00:00	27	00:00:00:00:00:00
12	00:00:00:00:00:00	28	00:00:00:00:00:00
13	00:00:00:00:00:00	29	00:00:00:00:00:00
14	00:00:00:00:00:00	30	00:00:00:00:00:00
15	00:00:00:00:00:00	31	00:00:00:00:00:00
16	00:00:00:00:00:00	32	00:00:00:00:00:00

Apply Cancel

The following table describes the labels in this menu.

**Table 36** MAC Address Filter

LABEL	DESCRIPTION
Active	Select the check box to enable MAC address filtering.
Filter Action	Define the filter action for the list of MAC addresses in the <b>MAC Address</b> table. Select <b>Deny</b> to block access to the ZyXEL Device, MAC addresses not listed will be allowed to access the ZyXEL Device Select <b>Allow</b> to permit access to the ZyXEL Device, MAC addresses not listed will be denied access to the ZyXEL Device.
Set	This is the index number of the MAC address.
MAC Address	Enter the MAC addresses of the wireless station that are allowed or denied access to the ZyXEL Device in these address fields. Enter the MAC addresses in a valid MAC address format, that is, six hexadecimal character pairs, for example, 12:34:56:78:9a:bc.
Apply	Click <b>Apply</b> to save your changes back to the ZyXEL Device.
Cancel	Click <b>Cancel</b> to reload the previous configuration for this screen.

## 5.7 Wireless LAN Advanced Setup

To configure advanced wireless settings, click the **Advanced Setup** button in the **General** screen. The screen appears as shown.

**Figure 48** Wireless LAN: Advanced

The following table describes the labels in this screen.

**Table 37** Wireless LAN: Advanced

LABEL	DESCRIPTION
Wireless Advanced Setup	
RTS/CTS Threshold	Enter a value between 0 and 2432.
Fragmentation Threshold	It is the maximum data fragment size that can be sent. Enter a value between 256 and 2432.
802.11 Mode	Select <b>802.11b</b> to allow only IEEE 802.11b compliant WLAN devices to associate with the ZyXEL Device. Select <b>802.11g</b> to allow only IEEE 802.11g compliant WLAN devices to associate with the ZyXEL Device. Select <b>802.11b/g</b> to allow either IEEE 802.11b or IEEE 802.11g compliant WLAN devices to associate with the ZyXEL Device. The transmission rate of your ZyXEL Device might be reduced.
Apply	Click <b>Apply</b> to save your changes back to the ZyXEL Device.
Cancel	Click <b>Cancel</b> to reload the previous configuration for this screen.



Use these screens to set up the ZyXEL Device on the WAN. You can configure the Internet connection, DNS servers, and how the ZyXEL Device sends routing information using RIP. In addition, you can set up a backup gateway in case the default gateway is not available.

## 6.1 WAN Overview

### 6.1.1 PPPoE Encapsulation

The ZyXEL Device supports PPPoE (Point-to-Point Protocol over Ethernet). PPPoE is an IETF standard (RFC 2516) specifying how a personal computer (PC) interacts with a broadband modem (DSL, cable, wireless, etc.) connection. The **PPP over Ethernet** option is for a dial-up connection using PPPoE.

For the service provider, PPPoE offers an access and authentication method that works with existing access control systems (for example Radius).

One of the benefits of PPPoE is the ability to let you access one of multiple network services, a function known as dynamic service selection. This enables the service provider to easily create and offer new IP services for individuals.

Operationally, PPPoE saves significant effort for both you and the ISP or carrier, as it requires no specific configuration of the broadband modem at the customer site.

By implementing PPPoE directly on the ZyXEL Device (rather than individual computers), the computers on the LAN do not need PPPoE software installed, since the ZyXEL Device does that part of the task. Furthermore, with NAT, all of the LANs' computers will have access.

### 6.1.2 WAN IP Address Assignment

Every computer on the Internet must have a unique IP address. If your networks are isolated from the Internet, for instance, only between your two branch offices, you can assign any IP addresses to the hosts without problems. However, the Internet Assigned Numbers Authority (IANA) has reserved the following three blocks of IP addresses specifically for private networks.

**Table 38** Private IP Address Ranges

10.0.0.0	-	10.255.255.255
172.16.0.0	-	172.31.255.255
192.168.0.0	-	192.168.255.255

You can obtain your IP address from the IANA, from an ISP or have it assigned by a private network. If you belong to a small organization and your Internet access is through an ISP, the ISP can provide you with the Internet addresses for your local networks. On the other hand, if you are part of a much larger organization, you should consult your network administrator for the appropriate IP addresses.



---

**Regardless of your particular situation, do not create an arbitrary IP address; always follow the guidelines above. For more information on address assignment, please refer to RFC 1597, Address Allocation for Private Internets and RFC 1466, Guidelines for Management of IP Address Space.**

---

### 6.1.3 MAC Address

Every Ethernet device has a unique MAC (Media Access Control) address. The MAC address is assigned at the factory and consists of six pairs of hexadecimal characters, for example, 00:A0:C5:00:00:02.

The MAC address screen allows users to configure the WAN port's MAC address by either using the factory default or cloning your computer's MAC address. Choose **Factory Default** to select the factory assigned default MAC Address.

Otherwise, click **Spoof this computer's MAC address - IP Address** and enter the IP address of your computer. Once it is successfully configured, the address will be copied to the rom file (ZyNOS configuration file). It will not change unless you change the setting or upload a different ROM file. It is recommended that you clone the MAC address prior to hooking up the WAN Port.

### 6.1.4 RIP Setup

See [Section 7.1.5 on page 107](#).

### 6.1.5 DNS Server Address Assignment

The **Domain Name** entry is what is propagated to the DHCP clients on the LAN. If you leave this blank, the domain name obtained by DHCP from the ISP is used. While you must enter the host name (System Name) on each individual computer, the domain name can be assigned from the ZyXEL Device via DHCP.

Use DNS (Domain Name System) to map a domain name to its corresponding IP address and vice versa, for instance, the IP address of [www.zyxel.com](http://www.zyxel.com) is 204.217.0.2. The DNS server is extremely important because without it, you must know the IP address of a computer before you can access it.

The ZyXEL Device can get the DNS server addresses in the following ways.

- 1 The ISP tells you the DNS server addresses, usually in the form of an information sheet, when you sign up. If your ISP gives you DNS server addresses, enter them in the **DNS Server** fields in the **SYSTEM General** screen.



- 2 If the ISP did not give you DNS server information, leave the **DNS Server** fields in the **SYSTEM General** screen set to 0.0.0.0 for the ISP to dynamically assign the DNS server IP addresses.

## 6.2 WAN Screens

### 6.2.1 WAN Internet Connection Screen (Ethernet)

Use this screen to set up your Internet connection. This screen depends on the type of Internet connection you have.

Use this screen to set up an Ethernet connection (no Roadrunner service) with the ISP. To access this screen, click **Network > WAN > Internet Connection**.

**Figure 49** Network > WAN > Internet Connection (Ethernet)



**Some ISPs, such as Telstra, send UDP heartbeat packets to verify that the customer is still online. In this case, create a WAN to LAN firewall rule for those packets. Contact your ISP to find the correct port number.**

Each field is described in the following table.

**Table 39** Network > WAN > Internet Connection (Ethernet)

LABEL	DESCRIPTION
ISP Parameters for Internet Access	
Encapsulation	Select <b>Ethernet</b> . Ethernet encapsulation with <b>Service Type</b> set to <b>Standard</b> is typically used if you are extending your existing network.
Service Type	Select <b>Standard</b> .
WAN IP Address Assignment	
Get automatically from ISP	Select this if your ISP did not assign you a static IP address or if you want another DHCP server to assign an IP address to the ZyXEL Device.
Use Fixed IP Address	Select this if your ISP assigned you a static IP address.
IP Address	Enter the IP address provided by your ISP.
IP Subnet Mask	Enter the subnet mask provided by your ISP.
Gateway IP Address	Enter the gateway provided by your ISP. If your ISP did not provide one, leave it blank.
WAN MAC Address	
Spoof WAN MAC Address	Select this if you do not want to use the default MAC address for the ZyXEL Device.
Clone the computer's MAC address - IP Address	This field is enabled if you select <b>Spoof WAN MAC Address</b> . Enter the IP address of the computer whose MAC address you want the ZyXEL Device to use instead of the default MAC address.
Apply	Click this to save your changes and to apply them to the ZyXEL Device.
Cancel	Click this to set every field in this screen to its last-saved value.

## 6.2.2 WAN Internet Connection Screen (Roadrunner)

Use this screen to set up an Ethernet connection using Roadrunner service with the ISP. To access this screen, click **Network > WAN > Internet Connection**.

**Figure 50** Network > WAN > Internet Connection (Roadrunner)

Each field is described in the following table.

**Table 40** Network > WAN > Internet Connection (Roadrunner)

LABEL	DESCRIPTION
ISP Parameters for Internet Access	
Encapsulation	Select <b>Ethernet</b> .
Service Type	Select the Roadrunner service provided by your ISP.
User Name	Enter the user name provided by your ISP.
Password	Enter the password provided by your ISP.
Retype to Confirm	Retype your password to make sure you entered it correctly.
Login Server IP Address	Enter the IP address of the login server provided by your ISP.
WAN MAC Address	
Spoof WAN MAC Address	Select this if you do not want to use the default MAC address for the ZyXEL Device.
Clone the computer's MAC address - IP Address	This field is enabled if you select <b>Spoof WAN MAC Address</b> . Enter the IP address of the computer whose MAC address you want the ZyXEL Device to use instead of the default MAC address.
Apply	Click this to save your changes and to apply them to the ZyXEL Device.
Reset	Click this to set every field in this screen to its last-saved value.

### 6.2.3 WAN Internet Connection Screen (PPPoE)

Use this screen to set up a PPPoE connection with the ISP. To access this screen, click **Network > WAN > Internet Connection**.

**Figure 51** Network > WAN > Internet Connection (PPPoE)

Each field is described in the following table.

**Table 41** Network > WAN > Internet Connection (PPPoE)

LABEL	DESCRIPTION
ISP Parameters for Internet Access	
Encapsulation	Select <b>PPP over Ethernet</b> .
Service Name	Enter the PPP service name provided by your ISP. If your ISP did not provide a service name, leave this field blank.
User Name	Enter the user name provided by your ISP.
Password	Enter the password provided by your ISP.
Retype to Confirm	Retype your password to make sure you entered it correctly.
Nailed-Up Connection	Select this if you do not want the ZyXEL Device to time out when the connection is idle for too long.
Idle Timeout	This field is enabled if you do not select <b>Nailed-Up Connection</b> . Enter the number of seconds that the connection should be idle before the ZyXEL Device automatically disconnects. Enter zero if you do not want the ZyXEL Device to automatically disconnect. (This is the same as selecting <b>Nailed-Up Connection</b> .)
WAN IP Address Assignment	

**Table 41** Network > WAN > Internet Connection (PPPoE)

LABEL	DESCRIPTION
Get automatically from ISP	Select this if your ISP did not assign you a static IP address.
Use Fixed IP Address	Select this if your ISP assigned you a static IP address.
My WAN IP Address	Enter the IP address provided by your ISP.
Remote IP Address	Enter the IP address your ISP provided for the remote (peer) server.
Remote IP Subnet Mask	Enter the subnet mask your ISP provided for the remote server.
Metric	Usually, you should keep the default value. This field is related to RIP. See <a href="#">Chapter 7 on page 105</a> for more information. The metric represents the "cost of transmission". A router determines the best route for transmission by choosing a path with the lowest "cost". The smaller the metric, the lower the "cost". RIP uses hop count as the measurement of cost, where 1 is for a directly-connected network. The metric must be 1-15; if you use a value higher than 15, the routers assume the link is down.
Private	Usually, you should keep the default value. This field is related to RIP. See <a href="#">Chapter 7 on page 105</a> for more information. This field determines whether or not the ZyXEL Device includes the route to this remote node in its RIP broadcasts. If you select <b>Yes</b> , this route is not included in RIP broadcast. If you select <b>No</b> , the route to this remote node is propagated to other hosts through RIP broadcasts.
WAN MAC Address	
Spoof WAN MAC Address	Select this if you do not want to use the default MAC address for the ZyXEL Device.
Clone the computer's MAC address - IP Address	This field is enabled if you select <b>Spoof WAN MAC Address</b> . Enter the IP address of the computer whose MAC address you want the ZyXEL Device to use instead of the default MAC address.
Apply	Click this to save your changes and to apply them to the ZyXEL Device.
Cancel	Click this to set every field in this screen to its last-saved value.

## 6.2.4 WAN Advanced Screen

Use this screen to set up DNS servers, RIP, and Windows Networking policies for the WAN. To access this screen, click **Network > WAN > Advanced**.

**Figure 52** Network > WAN > Advanced

Each field is described in the following table.

**Table 42** Network > WAN > Advanced

LABEL	DESCRIPTION
DNS Servers	DNS (Domain Name System) manages the relationships between domain names and IP addresses. Without a DNS server, you must know the IP address of the computer you want to access before you access it.
First DNS Server Second DNS Server Third DNS Server	Select <b>From ISP</b> if your ISP dynamically assigns DNS server information. (In this case, the ISP assigns the WAN IP address too. See <b>Network &gt; WAN &gt; Internet Connection</b> .) The field to the right is read-only, and it displays the IP address provided by your ISP. Select <b>User-Defined</b> if you have the IP address of a DNS server. You might get it from your ISP or from your network. Enter the IP address in the field to the right. Select <b>None</b> if you do not want to use this DNS server. If you select <b>None</b> for all of the DNS servers, you must use IP addresses to configure the ZyXEL Device and to access the Internet.
RIP & Multicast Setup	
RIP Direction	Use this field to control how much routing information the ZyXEL Device sends and receives on the subnet. <b>None</b> - The ZyXEL Device does not send or receive routing information on the subnet. <b>Both</b> - The ZyXEL Device sends and receives routing information on the subnet. <b>In Only</b> - The ZyXEL Device only receives routing information on the subnet. <b>Out Only</b> - The ZyXEL Device only sends routing information on the subnet.
RIP Version	Select which version of RIP the ZyXEL Device uses when it sends or receives information on the subnet. <b>RIP-1</b> - The ZyXEL Device uses RIPv1 to exchange routing information. <b>RIP-2B</b> - The ZyXEL Device broadcasts RIPv2 to exchange routing information. <b>RIP-2M</b> - The ZyXEL Device multicasts RIPv2 to exchange routing information.

**Table 42** Network > WAN > Advanced

LABEL	DESCRIPTION
Multicast	Select which version of IGMP the ZyXEL Device uses to support multicasting on the WAN. Multicasting sends packets to some computers on the WAN and is an alternative to unicasting (sending packets to one computer) and broadcasting (sending packets to every computer). <b>None</b> - The ZyXEL Device does not support multicasting. <b>IGMP-v1</b> - The ZyXEL Device supports IGMP version 1. <b>IGMP-v2</b> - The ZyXEL Device supports IGMP version 2. Multicasting can improve overall network performance. However, it requires extra processing and generates more network traffic. In addition, other computers on the WAN have to support the same version of IGMP.
Windows Networking	NetBIOS over TCP/IP
Allow between LAN and WAN	Select this check box if you want the ZyXEL Device to send NetBIOS (Network Basic Input/Output System) packets between the LAN and WAN. You should also make sure that NetBIOS packets are not blocked in <b>Security &gt; Firewall &gt; Services</b> . NetBIOS packets are TCP or UDP packets that enable a computer to connect to and communicate with computers on other networks. It may sometimes be necessary to allow NetBIOS packets to pass through the ZyXEL Device in order to allow computers on the LAN to find computers on the WAN and vice versa. This is the same setting you can set in <b>Network &gt; LAN &gt; Advanced</b> .
Allow Trigger Dial	Select this if you want to allow NetBIOS packets to initiate calls.
Apply	Click this to save your changes and to apply them to the ZyXEL Device.
Cancel	Click this to set every field in this screen to its last-saved value.

## 6.2.5 WAN Traffic Redirect Screen

Use this screen to specify a backup gateway in case the default gateway (your ISP) is not available. To access this screen, click **Network > WAN > Traffic Redirect**.

**Figure 53** Network > WAN > Traffic Redirect

The screenshot shows the 'Traffic Redirect' configuration screen. At the top, there are three tabs: 'Internet Connection', 'Advanced', and 'Traffic Redirect'. The 'Traffic Redirect' tab is selected. Below the tabs, the screen title is 'Traffic Redirect'. There is a checked checkbox for 'Active'. Below that are several fields: 'Backup Gateway IP Address' with a text box containing '0.0.0.0', 'Check WAN IP Address' with a text box containing '0.0.0.0', 'Fail Tolerance' with a text box containing '2', 'Period (sec)' with a text box containing '5' and '(in seconds)' to its right, and 'Timeout (sec)' with a text box containing '3' and '(in seconds)' to its right. At the bottom of the screen, there are two buttons: 'Apply' and 'Cancel'.

Each field is described in the following table.

**Table 43** Network > WAN > Traffic Redirect

LABEL	DESCRIPTION
Active	Select this to set up a backup gateway in case the default gateway is not available. (For example, this might happen if the Internet connection goes down.) Clear this if you do not have a backup gateway.
Backup Gateway IP Address	Enter the IP address of the backup gateway. The ZyXEL Device automatically uses this gateway if the default gateway is not available anymore.
Check WAN IP Address	Enter the IP address of a reliable nearby computer the ZyXEL Device uses to test whether or not the default gateway is available anymore. For example, use one of your ISP's DNS server addresses. If you enter 0.0.0.0, the test fails each time.
Fail Tolerance	Enter the number of consecutive times the ZyXEL Device may attempt and fail to find the reliable nearby computer at <b>Check WAN IP Address</b> before it starts using the backup gateway. 2 - 5 are typical choices.
Period (sec)	Enter the number of seconds between attempts to find the reliable nearby computer at <b>Check WAN IP Address</b> . 5 - 60 are typical choices.
Timeout (sec)	Enter the number of seconds the ZyXEL Device waits for a response from the reliable nearby computer at <b>Check WAN IP Address</b> before the attempt is a failure. 3 - 50 are typical choices, but this number should be less than the <b>Period</b> .
Apply	Click this to save your changes and to apply them to the ZyXEL Device.
Cancel	Click this to set every field in this screen to its last-saved value.



Use these screens to set up the ZyXEL Device on the LAN. You can configure its IP address and subnet mask, DHCP services, and other subnets. You can also control how the ZyXEL Device sends routing information using RIP, and you can enable and disable Any IP.

## 7.1 LAN Overview

A Local Area Network (LAN) is a shared communication system to which many computers are attached. A LAN is usually a computer network limited to the immediate area, such as the same building or floor of a building.

### 7.1.1 IP Address and Subnet Mask

Similar to the way houses on a street share a common street name, so too do computers on a LAN share one common network number.

Where you obtain your network number depends on your particular situation. If the ISP or your network administrator assigns you a block of registered IP addresses, follow their instructions in selecting the IP addresses and the subnet mask.

If the ISP did not explicitly give you an IP network number, then most likely you have a single user account and the ISP will assign you a dynamic IP address when the connection is established. If this is the case, it is recommended that you select a network number from 192.168.0.0 to 192.168.255.0 and you must enable the Network Address Translation (NAT) feature of the ZyXEL Device. The Internet Assigned Number Authority (IANA) reserved this block of addresses specifically for private use; please do not use any other number unless you are told otherwise. Let's say you select 192.168.1.0 as the network number; which covers 254 individual addresses, from 192.168.1.1 to 192.168.1.254 (zero and 255 are reserved). In other words, the first three numbers specify the network number while the last number identifies an individual computer on that network.

Once you have decided on the network number, pick an IP address that is easy to remember, for instance, 192.168.1.1, for your ZyXEL Device, but make sure that no other device on your network is using that IP address.

The subnet mask specifies the network number portion of an IP address. Your ZyXEL Device will compute the subnet mask automatically based on the IP address that you entered. You don't need to change the subnet mask computed by the ZyXEL Device unless you are instructed to do otherwise.

## 7.1.2 DHCP Setup

DHCP (Dynamic Host Configuration Protocol, RFC 2131 and RFC 2132) allows individual clients to obtain TCP/IP configuration at start-up from a server. You can configure the ZyXEL Device as a DHCP server or disable it. When configured as a server, the ZyXEL Device provides the TCP/IP configuration for the clients. If DHCP service is disabled, you must have another DHCP server on your LAN, or else each computer must be manually configured.

The ZyXEL Device is pre-configured with a pool of IP addresses for the DHCP clients (DHCP Pool). See the product specifications in the appendices. Do not assign static IP addresses from the DHCP pool to your LAN computers.

These parameters should work for the majority of installations. If your ISP gives you explicit DNS server address(es), read the embedded web configurator help regarding what fields need to be configured.

## 7.1.3 LAN TCP/IP

The ZyXEL Device has built-in DHCP server capability that assigns IP addresses and DNS servers to systems that support DHCP client capability.

The LAN parameters of the ZyXEL Device are preset in the factory with the following values:

- IP address of 192.168.1.1 with subnet mask of 255.255.255.0 (24 bits)
- DHCP server enabled with 32 client IP addresses starting from 192.168.1.33.

These parameters should work for the majority of installations. If your ISP gives you explicit DNS server address(es), read the embedded web configurator help regarding what fields need to be configured.

## 7.1.4 DNS Server Address

DNS (Domain Name System) is for mapping a domain name to its corresponding IP address and vice versa. The DNS server is extremely important because without it, you must know the IP address of a machine before you can access it. The DNS server addresses that you enter in the DHCP setup are passed to the client machines along with the assigned IP address and subnet mask.

There are two ways that an ISP disseminates the DNS server addresses. The first is for an ISP to tell a customer the DNS server addresses, usually in the form of an information sheet, when s/he signs up. If your ISP gives you the DNS server addresses, enter them in the **DNS Server** fields in **DHCP Setup**, otherwise, leave them blank.

Some ISPs choose to pass the DNS servers using the DNS server extensions of PPP IPCP (IP Control Protocol) after the connection is up. If your ISP did not give you explicit DNS servers, chances are the DNS servers are conveyed through IPCP negotiation. The ZyXEL Device supports the IPCP DNS server extensions through the DNS proxy feature.

If the **Primary** and **Secondary DNS Server** fields in the **LAN Setup** screen are not specified, for instance, left as 0.0.0.0, the ZyXEL Device tells the DHCP clients that it itself is the DNS server. When a computer sends a DNS query to the ZyXEL Device, the ZyXEL Device forwards the query to the real DNS server learned through IPCP and relays the response back to the computer.

Please note that DNS proxy works only when the ISP uses the IPCP DNS server extensions. It does not mean you can leave the DNS servers out of the DHCP setup under all circumstances. If your ISP gives you explicit DNS servers, make sure that you enter their IP addresses in the **LAN Setup** screen. This way, the ZyXEL Device can pass the DNS servers to the computers and the computers can query the DNS server directly without the ZyXEL Device's intervention.

## 7.1.5 RIP Setup

RIP (Routing Information Protocol) allows a router to exchange routing information with other routers. The **RIP Direction** field controls the sending and receiving of RIP packets. When set to:

- **Both** - the ZyXEL Device will broadcast its routing table periodically and incorporate the RIP information that it receives.
- **In Only** - the ZyXEL Device will not send any RIP packets but will accept all RIP packets received.
- **Out Only** - the ZyXEL Device will send out RIP packets but will not accept any RIP packets received.
- **None** - the ZyXEL Device will not send any RIP packets and will ignore any RIP packets received.

The **Version** field controls the format and the broadcasting method of the RIP packets that the ZyXEL Device sends (it recognizes both formats when receiving). **RIP-1** is universally supported; but RIP-2 carries more information. RIP-1 is probably adequate for most networks, unless you have an unusual network topology.

Both **RIP-2B** and **RIP-2M** sends the routing data in RIP-2 format; the difference being that **RIP-2B** uses subnet broadcasting while **RIP-2M** uses multicasting.

## 7.1.6 Multicast

Traditionally, IP packets are transmitted in one of either two ways - Unicast (1 sender - 1 recipient) or Broadcast (1 sender - everybody on the network). Multicast delivers IP packets to a group of hosts on the network - not everybody and not just 1.

IGMP (Internet Group Multicast Protocol) is a network-layer protocol used to establish membership in a Multicast group - it is not used to carry user data. IGMP version 2 (RFC 2236) is an improvement over version 1 (RFC 1112) but IGMP version 1 is still in wide use. If you would like to read more detailed information about interoperability between IGMP version 2 and version 1, please see sections 4 and 5 of RFC 2236. The class D IP address is used to identify host groups and can be in the range 224.0.0.0 to 239.255.255.255. The address 224.0.0.0 is not assigned to any group and is used by IP multicast computers. The address 224.0.0.1 is used for query messages and is assigned to the permanent group of all IP hosts (including gateways). All hosts must join the 224.0.0.1 group in order to participate in IGMP. The address 224.0.0.2 is assigned to the multicast routers group.

The ZyXEL Device supports both IGMP version 1 (**IGMP-v1**) and IGMP version 2 (**IGMP-v2**). At start up, the ZyXEL Device queries all directly connected networks to gather group membership. After that, the ZyXEL Device periodically updates this information. IP multicasting can be enabled/disabled on the ZyXEL Device LAN and/or WAN interfaces in the web configurator (**LAN**; **WAN**). Select **None** to disable IP multicasting on these interfaces.

### 7.1.7 Any IP

Traditionally, you must set the IP addresses and the subnet masks of a computer and the ZyXEL Device to be in the same subnet to allow the computer to access the Internet (through the ZyXEL Device). In cases where your computer is required to use a static IP address in another network, you may need to manually configure the network settings of the computer every time you want to access the Internet via the ZyXEL Device.

With the Any IP feature and NAT enabled, the ZyXEL Device allows a computer to access the Internet without changing the network settings (such as IP address and subnet mask) of the computer, when the IP addresses of the computer and the ZyXEL Device are not in the same subnet. Whether a computer is set to use a dynamic or static (fixed) IP address, you can simply connect the computer to the ZyXEL Device and access the Internet.

The following figure depicts a scenario where a computer is set to use a static private IP address in the corporate environment. In a residential house where a ZyXEL Device is installed, you can still use the computer to access the Internet without changing the network settings, even when the IP addresses of the computer and the ZyXEL Device are not in the same subnet.

**Figure 54** Any IP Example

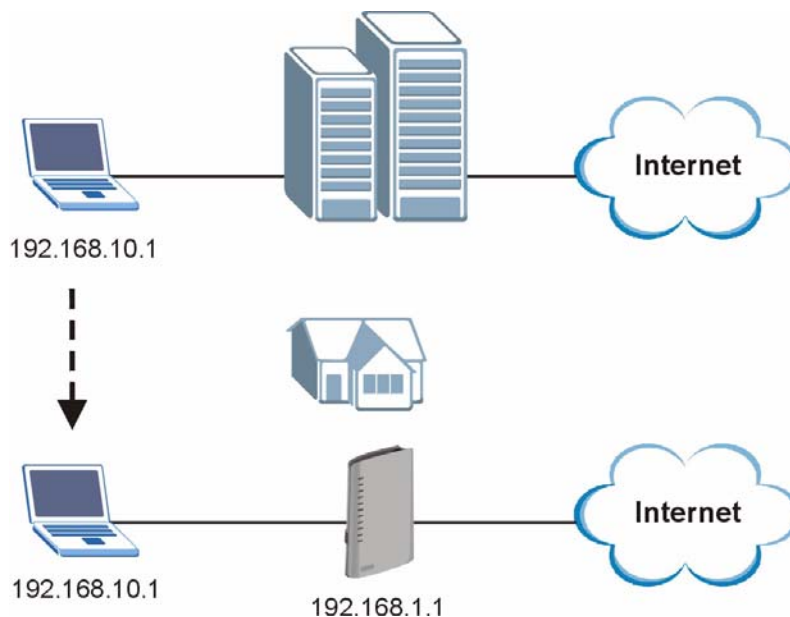

The Any IP feature does not apply to a computer using either a dynamic IP address or a static IP address that is in the same subnet as the ZyXEL Device's IP address.



**You *must* enable NAT to use the Any IP feature on the ZyXEL Device.**

Address Resolution Protocol (ARP) is a protocol for mapping an Internet Protocol address (IP address) to a physical machine address, also known as a Media Access Control or MAC address, on the local area network. IP routing table is defined on IP Ethernet devices (the ZyXEL Device) to decide which hop to use, to help forward data along to its specified destination.

The following lists out the steps taken, when a computer tries to access the Internet for the first time through the ZyXEL Device.

- 1 When a computer (which is in a different subnet) first attempts to access the Internet, it sends packets to its default gateway (which is not the ZyXEL Device) by looking at the MAC address in its ARP table.
- 2 When the computer cannot locate the default gateway, an ARP request is broadcast on the LAN.
- 3 The ZyXEL Device receives the ARP request and replies to the computer with its own MAC address.
- 4 The computer updates the MAC address for the default gateway to the ARP table. Once the ARP table is updated, the computer is able to access the Internet through the ZyXEL Device.
- 5 When the ZyXEL Device receives packets from the computer, it creates an entry in the IP routing table so it can properly forward packets intended for the computer.

After all the routing information is updated, the computer can access the ZyXEL Device and the Internet as if it is in the same subnet as the ZyXEL Device.

## 7.2 LAN Screens

### 7.2.1 LAN IP Screen

Use this screen to set up the ZyXEL Device's IP address and subnet mask. To access this screen, click **Network > LAN > IP**.

**Figure 55** Network > LAN > IP

The screenshot shows the 'LAN TCP/IP' configuration page. At the top, there are tabs for 'IP', 'DHCP Setup', 'Static DHCP', 'Client List', 'IP Alias', and 'Advanced'. The 'IP' tab is selected. Below the tabs, the 'LAN TCP/IP' section is visible. It contains two input fields: 'IP Address' with the value '192.168.1.1' and 'IP Subnet Mask' with the value '255.255.255.0'. Below these fields are two buttons: 'Apply' and 'Cancel'.

Each field is described in the following table.

**Table 44** Network > LAN > IP

LABEL	DESCRIPTION
IP Address	Enter the IP address of the ZyXEL Device on the LAN.  <b>Note: This field is the IP address you use to access the ZyXEL Device on the LAN. If the web configurator is running on a computer on the LAN, you lose access to the web configurator as soon as you change this field and click Apply. You can access the web configurator again by typing the new IP address in the browser.</b>
IP Subnet Mask	Enter the subnet mask of the LAN.
Apply	Click this to save your changes and to apply them to the ZyXEL Device.
Cancel	Click this to set every field in this screen to its last-saved value.

## 7.2.2 LAN DHCP Setup Screen

Use this screen to enable, disable, and configure the DHCP server in the ZyXEL Device. To access this screen, click **Network > LAN > DHCP Setup**.

**Figure 56** Network > LAN > DHCP Setup

Each field is described in the following table.

**Table 45** Network > LAN > DHCP Setup

LABEL	DESCRIPTION
DHCP Setup	
Enable DHCP Server	Select this if you want the ZyXEL Device to be the DHCP server on the LAN. As a DHCP server, the ZyXEL Device assigns IP addresses to DHCP clients on the LAN and provides the subnet mask and DNS server information.
IP Pool Starting Address	Enter the IP address from which the ZyXEL Device begins allocating IP addresses, if you have not specified an IP address for this computer in <b>Network &gt; LAN &gt; Static DHCP</b> .

**Table 45** Network > LAN > DHCP Setup

LABEL	DESCRIPTION
Pool Size	Enter the number of IP addresses to allocate. This number must be at least one and is limited by a subnet mask of 255.255.255.0 (regardless of the subnet the ZyXEL Device is in). For example, if the <b>IP Pool Start Address</b> is 10.10.10.10, the ZyXEL Device can allocate up to 10.10.10.254, or 245 IP addresses.
DNS Server	
First DNS Server Second DNS Server Third DNS Server	Specify the IP addresses of a maximum of three DNS servers that the network can use. The ZyXEL Device provides these IP addresses to DHCP clients. You can specify these IP addresses two ways. <b>From ISP</b> - provide the DNS servers provided by the ISP on the WAN port. <b>User Defined</b> - enter a static IP address. <b>DNS Relay</b> - this setting will relay DNS information from the DNS server obtained by the ZyXEL Device. <b>None</b> - no DNS service will be provided by the ZyXEL Device.
Apply	Click this to save your changes and to apply them to the ZyXEL Device.
Cancel	Click this to set every field in this screen to its last-saved value.

### 7.2.3 LAN Static DHCP Screen



**This screen has no effect if the DHCP server is not enabled. You can enable it in Network > LAN > DHCP Setup.**

Use this screen to make the ZyXEL Device assign a specific IP address to a specific computer on the LAN. To access this screen, click **Network > LAN > Static DHCP**.

**Figure 57** Network > LAN > Static DHCP

#	MAC Address	IP Address
1	<input type="text"/>	0.0.0.0
2	<input type="text"/>	0.0.0.0
3	<input type="text"/>	0.0.0.0
4	<input type="text"/>	0.0.0.0
5	<input type="text"/>	0.0.0.0
6	<input type="text"/>	0.0.0.0
7	<input type="text"/>	0.0.0.0
8	<input type="text"/>	0.0.0.0

Each field is described in the following table.

**Table 46** Network > LAN > Static DHCP

LABEL	DESCRIPTION
#	This field is a sequential value. It is not associated with a specific entry.
MAC Address	Enter the MAC address of the computer to which you want the ZyXEL Device to assign the same IP address.
IP Address	Enter the IP address you want the ZyXEL Device to assign to the computer.
Apply	Click this to save your changes and to apply them to the ZyXEL Device.
Cancel	Click this to set every field in this screen to its last-saved value.

## 7.2.4 LAN Client List Screen



**This screen is empty if the DHCP server is not enabled. You can enable it in Network > LAN > DHCP Setup.**

Use this screen to look at the IP addresses the ZyXEL Device has assigned to DHCP clients on the LAN. To access this screen, click **Network > LAN > Client List**.

**Figure 58** Network > LAN > Client List

#	IP Address	Host Name	MAC Address	Reserve
1	192.168.1.33	tw11477-02	00:50:8d:48:59:1f	<input type="checkbox"/>

Each field is described in the following table.

**Table 47** Network > LAN > Client List

LABEL	DESCRIPTION
#	This field is a sequential value. It is not associated with a specific entry.
IP Address	This field displays the IP address the ZyXEL Device assigned to the computer.
Host Name	This field displays the system name of the computer to which the ZyXEL Device assigned the IP address.
MAC Address	This field displays the MAC address of the computer to which the ZyXEL Device assigned the IP address.
Reserve	Select this if you always want to assign this IP address to this MAC address. Then, click <b>Apply</b> . The ZyXEL Device creates an entry in the <b>LAN Static DHCP</b> screen. See <a href="#">Section 7.2.2 on page 110</a> .
Apply	Click this to save your changes and to apply them to the ZyXEL Device.
Refresh	Click this to update this screen with current DHCP client information.



## 7.2.5 LAN IP Alias Screen

Use this screen to add subnets on the LAN port. You can also control what routing information is sent and received by each subnet. To access this screen, click **Network > LAN > IP Alias**.

**Figure 59** Network > LAN > IP Alias

Each field is described in the following table.

**Table 48** Network > LAN > IP Alias

LABEL	DESCRIPTION
IP Alias 1	
IP Alias 1	Select this to add the specified subnet to the LAN port.
IP Address	Enter the IP address of the ZyXEL Device on the subnet.
IP Subnet Mask	Enter the subnet mask of the subnet.
RIP Direction	Use this field to control how much routing information the ZyXEL Device sends and receives on the subnet. <b>None</b> - The ZyXEL Device does not send or receive routing information on the subnet. <b>Both</b> - The ZyXEL Device sends and receives routing information on the subnet. <b>In Only</b> - The ZyXEL Device only receives routing information on the subnet. <b>Out Only</b> - The ZyXEL Device only sends routing information on the subnet.
RIP Version	Select which version of RIP the ZyXEL Device uses when it sends or receives information on the subnet. <b>RIP-1</b> - The ZyXEL Device uses RIPv1 to exchange routing information. <b>RIP-2B</b> - The ZyXEL Device broadcasts RIPv2 to exchange routing information. <b>RIP-2M</b> - The ZyXEL Device multicasts RIPv2 to exchange routing information.
IP Alias 2	
IP Alias 2	Select this to add the specified subnet to the LAN port.
IP Address	Enter the IP address of the ZyXEL Device on the subnet.
IP Subnet Mask	Enter the subnet mask of the subnet.

**Table 48** Network > LAN > IP Alias

LABEL	DESCRIPTION
RIP Direction	Use this field to control how much routing information the ZyXEL Device sends and receives on the subnet. <b>None</b> - The ZyXEL Device does not send or receive routing information on the subnet. <b>Both</b> - The ZyXEL Device sends and receives routing information on the subnet. <b>In Only</b> - The ZyXEL Device only receives routing information on the subnet. <b>Out Only</b> - The ZyXEL Device only sends routing information on the subnet.
RIP Version	Select which version of RIP the ZyXEL Device uses when it sends or receives information on the subnet. <b>RIP-1</b> - The ZyXEL Device uses RIPv1 to exchange routing information. <b>RIP-2B</b> - The ZyXEL Device broadcasts RIPv2 to exchange routing information. <b>RIP-2M</b> - The ZyXEL Device multicasts RIPv2 to exchange routing information.
Apply	Click this to save your changes and to apply them to the ZyXEL Device.
Cancel	Click this to set every field in this screen to its last-saved value.

## 7.2.6 LAN Advanced Screen

Use this screen to add subnets on the LAN port. You can also control what routing information is sent and received by each subnet. To access this screen, click **Network > LAN > Advanced**.

**Figure 60** Network > LAN > Advanced

The screenshot displays the 'Advanced' configuration page for the LAN network. The interface includes a navigation bar with tabs for 'IP', 'DHCP Setup', 'Static DHCP', 'Client List', 'IP Alias', and 'Advanced'. The main content area is divided into three sections: 'RIP & Multicast Setup' with three dropdown menus (RIP Direction: Both, RIP Version: RIP-1, Multicast: None), 'Any IP Setup' with an unchecked 'Active' checkbox, and 'Windows Networking (NetBIOS over TCP/IP)' with a checked 'Allow between LAN and WAN' checkbox. At the bottom, there are 'Apply' and 'Cancel' buttons.

Each field is described in the following table.

**Table 49** Network > LAN > Advanced

LABEL	DESCRIPTION
RIP & Multicast Setup	
RIP Direction	<p>Use this field to control how much routing information the ZyXEL Device sends and receives on the subnet.</p> <p><b>None</b> - The ZyXEL Device does not send or receive routing information on the subnet.</p> <p><b>Both</b> - The ZyXEL Device sends and receives routing information on the subnet.</p> <p><b>In Only</b> - The ZyXEL Device only receives routing information on the subnet.</p> <p><b>Out Only</b> - The ZyXEL Device only sends routing information on the subnet.</p>
RIP Version	<p>Select which version of RIP the ZyXEL Device uses when it sends or receives information on the subnet.</p> <p><b>RIP-1</b> - The ZyXEL Device uses RIPv1 to exchange routing information.</p> <p><b>RIP-2B</b> - The ZyXEL Device broadcasts RIPv2 to exchange routing information.</p> <p><b>RIP-2M</b> - The ZyXEL Device multicasts RIPv2 to exchange routing information.</p>
Multicast	<p>You do not have to enable multicasting to use <b>RIP-2M</b>. (See <b>RIP Version</b>.)</p> <p>Select which version of IGMP the ZyXEL Device uses to support multicasting on the LAN. Multicasting sends packets to some computers on the LAN and is an alternative to unicasting (sending packets to one computer) and broadcasting (sending packets to every computer).</p> <p><b>None</b> - The ZyXEL Device does not support multicasting.</p> <p><b>IGMP-v1</b> - The ZyXEL Device supports IGMP version 1.</p> <p><b>IGMP-v2</b> - The ZyXEL Device supports IGMP version 2.</p> <p>Multicasting can improve overall network performance. However, it requires extra processing and generates more network traffic. In addition, other computers on the LAN have to support the same version of IGMP.</p>
Any IP Setup	
Active	<p>Select this if you want to let computers on different subnets use the ZyXEL Device.</p>
Windows Networking (NetBIOS over TCP/IP)	
Allow between LAN and WAN	<p>Select this check box if you want the ZyXEL Device to send NetBIOS (Network Basic Input/Output System) packets between the LAN and WAN. You should also make sure that NetBIOS packets are not blocked in <b>Security &gt; Firewall &gt; Services</b>.</p> <p>NetBIOS packets are TCP or UDP packets that enable a computer to connect to and communicate with computers on other networks. It may sometimes be necessary to allow NetBIOS packets to pass through the ZyXEL Device in order to allow computers on the LAN to find computers on the WAN and vice versa.</p> <p>This is the same setting you can set in <b>Network &gt; WAN &gt; Advanced</b>.</p>
Apply	<p>Click this to save your changes and to apply them to the ZyXEL Device.</p>
Cancel	<p>Click this to set every field in this screen to its last-saved value.</p>



Use these screens to configure port forwarding and trigger ports for the ZyXEL Device. You can also enable and disable SIP, FTP, and H.323 ALG.

## 8.1 NAT Overview

### 8.1.1 Port Forwarding: Services and Port Numbers

A NAT server set is a list of inside (behind NAT on the LAN) servers, for example, web or FTP, that you can make accessible to the outside world even though NAT makes your whole inside network appear as a single machine to the outside world.

Use the [NAT Port Forwarding Screen](#) to forward incoming service requests to the server(s) on your local network. You may enter a single port number or a range of port numbers to be forwarded, and the local IP address of the desired server. The port number identifies a service; for example, web service is on port 80 and FTP on port 21. In some cases, such as for unknown services or where one server can support more than one service (for example both FTP and web service), it might be better to specify a range of port numbers.

In addition to the servers for specified services, NAT supports a default server. A service request that does not have a server explicitly designated for it is forwarded to the default server. If the default is not defined, the service request is simply discarded.

See [Appendix G on page 339](#) for examples of services.

For example., let's say you want to assign ports 21-25 to one FTP, Telnet and SMTP server (A in the example), port 80 to another (B in the example) and assign a default server IP address of 192.168.1.35 to a third (C in the example). You assign the LAN IP addresses and the ISP assigns the WAN IP address. The NAT network appears as a single host on the Internet.

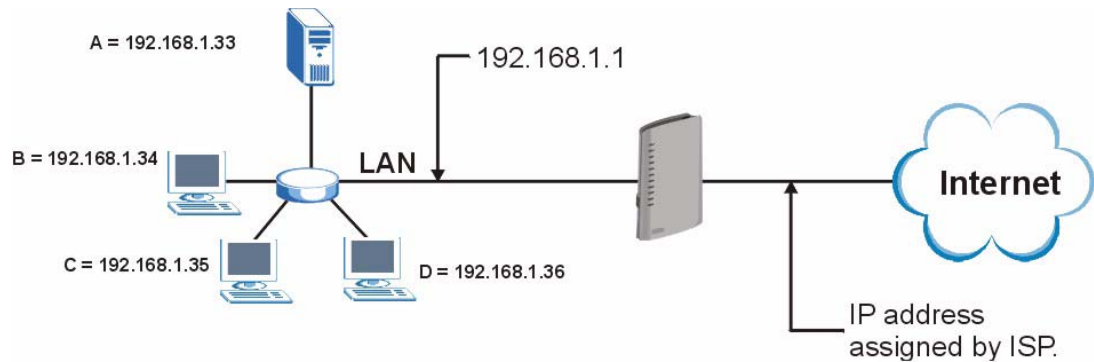
**Figure 61** Multiple Servers Behind NAT Example

## 8.1.2 Trigger Port Forwarding

Some services use a dedicated range of ports on the client side and a dedicated range of ports on the server side. With regular port forwarding you set a forwarding port in NAT to forward a service (coming in from the server on the WAN) to the IP address of a computer on the client side (LAN). The problem is that port forwarding only forwards a service to a single LAN IP address. In order to use the same service on a different LAN computer, you have to manually replace the LAN computer's IP address in the forwarding port with another LAN computer's IP address,

Trigger port forwarding solves this problem by allowing computers on the LAN to dynamically take turns using the service. The ZyXEL Device records the IP address of a LAN computer that sends traffic to the WAN to request a service with a specific port number and protocol (a "trigger" port). When the ZyXEL Device's WAN port receives a response with a specific port number and protocol ("incoming" port), the ZyXEL Device forwards the traffic to the LAN IP address of the computer that sent the request. After that computer's connection for that service closes, another computer on the LAN can use the service in the same manner. This way you do not need to configure a new IP address each time you want a different LAN computer to use the application.

### 8.1.2.1 Trigger Port Forwarding Example

The following is an example of trigger port forwarding.

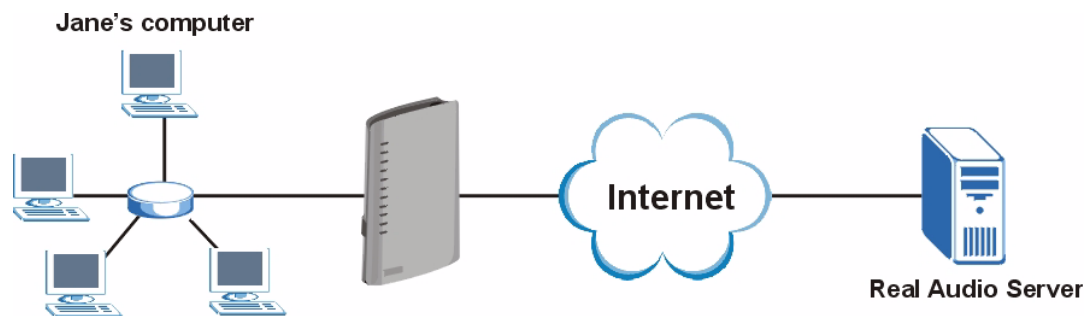
**Figure 62** Trigger Port Forwarding Process: Example

- 1 Jane requests a file from the Real Audio server (port 7070).

- 2 Port 7070 is a “trigger” port and causes the ZyXEL Device to record Jane’s computer IP address. The ZyXEL Device associates Jane’s computer IP address with the “incoming” port range of 6970-7170.
- 3 The Real Audio server responds using a port number ranging between 6970-7170.
- 4 The ZyXEL Device forwards the traffic to Jane’s computer IP address.
- 5 Only Jane can connect to the Real Audio server until the connection is closed or times out. The ZyXEL Device times out in three minutes with UDP (User Datagram Protocol), or two hours with TCP/IP (Transfer Control Protocol/Internet Protocol).

### 8.1.2.2 Two Points To Remember About Trigger Ports

- 1 Trigger events only happen on data that is going coming from inside the ZyXEL Device and going to the outside.
- 2 If an application needs a continuous data stream, that port (range) will be tied up so that another computer on the LAN can’t trigger it.

### 8.1.3 SIP ALG

Some NAT routers may include a SIP Application Layer Gateway (ALG). A SIP ALG allows SIP calls to pass through NAT by examining and translating IP addresses embedded in the data stream. When the ZyXEL Device registers with the SIP register server, the SIP ALG translates the ZyXEL Device’s private IP address inside the SIP data stream to a public IP address. You do not need to use STUN or an outbound proxy (see [Chapter 9 on page 127](#)) if your ZyXEL Device is behind a SIP ALG.

## 8.2 NAT Screens

### 8.2.1 NAT General Screen

Use this screen to enable and disable NAT and to allocate memory for NAT and firewall rules. To access this screen, click **Network > NAT > General**.

**Figure 63** Network > NAT > General

The screenshot shows the 'NAT Setup' configuration window. At the top, there are four tabs: 'General' (selected), 'Port Forwarding', 'Trigger Port', and 'ALG'. Below the tabs, the 'NAT Setup' section contains the following options:

- Enable Network Address Translation
- Max NAT/Firewall Session Per User:

At the bottom of the window, there are two buttons: 'Apply' and 'Cancel'.

Each field is described in the following table.

**Table 50** Network > NAT > General

LABEL	DESCRIPTION
NAT Setup	
Enable Network Address Translation	Select this if you want to use port forwarding, trigger ports, or any of the ALG.
Max NAT/Firewall Session Per User	When computers use peer to peer applications, such as file sharing applications, they may use a large number of NAT sessions. If you do not limit the number of NAT sessions a single client can establish, this can result in all of the available NAT sessions being used. In this case, no additional NAT sessions can be established, and users may not be able to access the Internet. Each NAT session establishes a corresponding firewall session. Use this field to limit the number of NAT/firewall sessions each client computer can establish through the ZyXEL Device.  If your network has a small number of clients using peer to peer applications, you can raise this number to ensure that their performance is not degraded by the number of NAT sessions they can establish. If your network has a large number of users using peer to peer applications, you can lower this number to ensure no single client is using all of the available NAT sessions.
Apply	Click this to save your changes and to apply them to the ZyXEL Device.
Cancel	Click this to set every field in this screen to its last-saved value.

## 8.2.2 NAT Port Forwarding Screen

Use this screen to look at the current port-forwarding rules in the ZyXEL Device, and to enable, disable, activate, and deactivate each one. You can also set up a default server to handle ports not covered by rules. To access this screen, click **Network > NAT > Port Forwarding**.

**Figure 64** Network > NAT > Port Forwarding

#	Active	Name	Start Port	End Port	Server IP Address	Modify
1	⚪		0	0		✎ 🗑
2	⚪		0	0		✎ 🗑
3	⚪		0	0		✎ 🗑
4	⚪		0	0		✎ 🗑
5	⚪		0	0		✎ 🗑
6	⚪		0	0		✎ 🗑
7	⚪		0	0		✎ 🗑
8	⚪		0	0		✎ 🗑
9	⚪		0	0		✎ 🗑
10	⚪		0	0		✎ 🗑
11	⚪		0	0		✎ 🗑



Each field is described in the following table.

**Table 51** Network > NAT > Port Forwarding

LABEL	DESCRIPTION
Default Server Setup	
Default Server	Enter the IP address of the server to which the ZyXEL Device should forward packets for ports that are not specified in the <b>Port Forwarding</b> section below or in the <b>Management &gt; Remote MGMT</b> screens. Enter 0.0.0.0 if you want the ZyXEL Device to discard these packets instead.
Port Forwarding	
#	This field is a sequential value, and it is not associated with a specific rule. The sequence is important, however. The ZyXEL Device checks each rule in order, and it only follows the first one that applies.
Active	Select this to enable this rule. Clear this to disable this rule.
Name	This field displays the name of the rule. It does not have to be unique.
Start Port	This field displays the beginning of the range of port numbers forwarded by this rule.
End Port	This field displays the end of the range of port numbers forwarded by this rule. If it is the same as the <b>Start Port</b> , only one port number is forwarded.
Server IP Address	This field displays the IP address of the server to which packet for the selected port(s) are forwarded.
Modify	This column provides icons to edit and delete rules. To edit a rule, click the <b>Edit</b> icon next to the rule. The <b>NAT Port Forwarding Edit</b> screen appears. To delete a rule, click the <b>Remove</b> icon next to the rule. All the information in the rule returns to the default settings.
Apply	Click this to save your changes and to apply them to the ZyXEL Device.
Cancel	Click this to set every field in this screen to its last-saved value.

### 8.2.3 NAT Port Forwarding Edit Screen

Use this screen to activate, deactivate, and edit each port-forwarding rule in the ZyXEL Device. To access this screen, click an **Edit** icon in **Network > NAT > Port Forwarding**.

**Figure 65** Network > NAT > Port Forwarding > Edit

The screenshot shows the 'Rule Setup' configuration screen. It includes a checkbox for 'Active', a text field for 'Service Name', and three text input fields for 'Start Port', 'End Port', and 'Server IP Address'. The 'Start Port' and 'End Port' fields contain the value '0', and the 'Server IP Address' field contains '0.0.0.0'. Below the input fields are two buttons: 'Apply' and 'Cancel'.

Each field is described in the following table.

**Table 52** Network > NAT > Port Forwarding > Edit

LABEL	DESCRIPTION
Active	Select this to enable this rule. Clear this to disable this rule.
Service Name	Enter a name to identify this rule. You can use 1 - 31 printable ASCII characters, or you can leave this field blank. It does not have to be a unique name.
Start Port End Port	Enter the port number or range of port numbers you want to forward to the specified server. To forward one port number, enter the port number in the <b>Start Port</b> and <b>End Port</b> fields. To forward a range of ports, <ul style="list-style-type: none"> <li>enter the port number at the beginning of the range in the <b>Start Port</b> field</li> <li>enter the port number at the end of the range in the <b>End Port</b> field.</li> </ul>
Server IP Address	Enter the IP address of the server to which to forward packets for the selected port number(s). This server is usually on the LAN.
Apply	Click this to save your changes and to apply them to the ZyXEL Device.
Cancel	Click this to set every field in this screen to its last-saved value.

## 8.2.4 NAT Trigger Port Screen

Use this screen to maintain port-triggering rules in the ZyXEL Device. To access this screen, click **Network > NAT > Trigger Port**.

**Figure 66** Network > NAT > Trigger Port

#	Name	Incoming		Trigger	
		Start Port	End Port	Start Port	End Port
1		0	0	0	0
2		0	0	0	0
3		0	0	0	0
4		0	0	0	0
5		0	0	0	0
6		0	0	0	0
7		0	0	0	0
8		0	0	0	0
9		0	0	0	0
10		0	0	0	0
11		0	0	0	0
12		0	0	0	0

Each field is described in the following table.

**Table 53** Network > NAT > Trigger Port

LABEL	DESCRIPTION
Name	Enter a name to identify this rule. You can use 1 - 15 printable ASCII characters, or you can leave this field blank. It does not have to be a unique name.
Incoming	
Start Port End Port	Enter the incoming port number or range of port numbers you want to forward to the IP address the ZyXEL Device records. To forward one port number, enter the port number in the <b>Start Port</b> and <b>End Port</b> fields. To forward a range of ports, <ul style="list-style-type: none"> <li>enter the port number at the beginning of the range in the <b>Start Port</b> field</li> <li>enter the port number at the end of the range in the <b>End Port</b> field.</li> </ul> If you want to delete this rule, enter zero in the <b>Start Port</b> and <b>End Port</b> fields.
Trigger	
Start Port End Port	Enter the outgoing port number or range of port numbers that makes the ZyXEL Device record the source IP address and assign it to the selected incoming port number(s). To select one port number, enter the port number in the <b>Start Port</b> and <b>End Port</b> fields. To select a range of ports, <ul style="list-style-type: none"> <li>enter the port number at the beginning of the range in the <b>Start Port</b> field</li> <li>enter the port number at the end of the range in the <b>End Port</b> field.</li> </ul> If you want to delete this rule, enter zero in the <b>Start Port</b> and <b>End Port</b> fields.
Apply	Click this to save your changes and to apply them to the ZyXEL Device.
Cancel	Click this to discard your changes.

## 8.2.5 NAT ALG Screen

Use this screen to enable and disable SIP (VoIP), FTP (file transfer), and H.323 (audio-visual) ALG in the ZyXEL Device. To access this screen, click **Network > NAT > ALG**.

**Figure 67** Network > NAT > ALG

The screenshot shows the 'ALG Setup' configuration page. At the top, there are tabs for 'General', 'Port Forwarding', 'Trigger Port', and 'ALG'. The 'ALG' tab is selected. Below the tabs, the 'ALG Setup' section contains three checked checkboxes: 'Enable SIP ALG', 'Enable FTP ALG', and 'Enable H.323 ALG'. At the bottom of the page, there are 'Apply' and 'Cancel' buttons.

Each field is described in the following table.

**Table 54** Network > NAT > ALG

LABEL	DESCRIPTION
Enable SIP ALG	Select this to make sure SIP (VoIP) works correctly with port-forwarding and port-triggering rules.
Enable FTP ALG	Select this to make sure FTP (file transfer) works correctly with port-forwarding and port-triggering rules.

**Table 54** Network > NAT > ALG

<b>LABEL</b>	<b>DESCRIPTION</b>
Enable H.323 ALG	Select this to make sure H.323 (audio-visual programs, such as NetMeeting) works correctly with port-forwarding and port-triggering rules.
Apply	Click this to save your changes and to apply them to the ZyXEL Device.
Cancel	Click this to discard your most recent changes.

---

# PART III

## VoIP

---

SIP (127)

Phone (141)

Phone Book (155)

PSTN Line (159)

VoIP Trunking (161)



Use these screens to set up your SIP accounts and to configure QoS settings.

## 9.1 SIP Overview

### 9.1.1 Introduction to VoIP

VoIP (Voice over IP) is the sending of voice signals over the Internet Protocol. This allows you to make phone calls and send faxes over the Internet at a fraction of the cost of using the traditional circuit-switched telephone network. You can also use servers to run telephone service applications like PBX services and voice mail. Internet Telephony Service Provider (ITSP) companies provide VoIP service. A company could alternatively set up an IP-PBX and provide its own VoIP service.

Circuit-switched telephone networks require 64 kilobits per second (kbps) in each direction to handle a telephone call. VoIP can use advanced voice coding techniques with compression to reduce the required bandwidth.

### 9.1.2 Introduction to SIP

The Session Initiation Protocol (SIP) is an application-layer control (signaling) protocol that handles the setting up, altering and tearing down of voice and multimedia sessions over the Internet.

SIP signaling is separate from the media for which it handles sessions. The media that is exchanged during the session can use a different path from that of the signaling. SIP handles telephone calls and can interface with traditional circuit-switched telephone networks.

### 9.1.3 SIP Identities

A SIP account uses an identity (sometimes referred to as a SIP address). A complete SIP identity is called a SIP URI (Uniform Resource Identifier). A SIP account's URI identifies the SIP account in a way similar to the way an e-mail address identifies an e-mail account. The format of a SIP identity is SIP-Number@SIP-Service-Domain.

#### 9.1.3.1 SIP Number

The SIP number is the part of the SIP URI that comes before the “@” symbol. A SIP number can use letters like in an e-mail address (johndoe@your-ITSP.com for example) or numbers like a telephone number (1122334455@VoIP-provider.com for example).

### 9.1.3.2 SIP Service Domain

The SIP service domain of the VoIP service provider (the company that lets you make phone calls over the Internet) is the domain name in a SIP URI. For example, if the SIP address is [1122334455@VoIP-provider.com](mailto:1122334455@VoIP-provider.com), then “VoIP-provider.com” is the SIP service domain.

### 9.1.4 SIP Call Progression

The following figure displays the basic steps in the setup and tear down of a SIP call. A calls B.

**Table 55** SIP Call Progression

A		B
1. INVITE	→	
	←	2. Ringing
	←	3. OK
4. ACK	→	
	5. Dialogue (voice traffic)	
6. BYE	→	
	←	7. OK

- 1 A sends a SIP INVITE request to B. This message is an invitation for B to participate in a SIP telephone call.
- 2 B sends a response indicating that the telephone is ringing.
- 3 B sends an OK response after the call is answered.
- 4 A then sends an ACK message to acknowledge that B has answered the call.
- 5 Now A and B exchange voice media (talk).
- 6 After talking, A hangs up and sends a BYE request.
- 7 B replies with an OK response confirming receipt of the BYE request and the call is terminated.

### 9.1.5 SIP Client Server

SIP is a client-server protocol. A SIP client is an application program or device that sends SIP requests. A SIP server responds to the SIP requests.

When you use SIP to make a VoIP call, it originates at a client and terminates at a server. A SIP client could be a computer or a SIP phone. One device can act as both a SIP client and a SIP server.

#### 9.1.5.1 SIP User Agent

A SIP user agent can make and receive VoIP telephone calls. This means that SIP can be used for peer-to-peer communications even though it is a client-server protocol. In the following figure, either A or B can act as a SIP user agent client to initiate a call. A and B can also both act as a SIP user agent to receive the call.

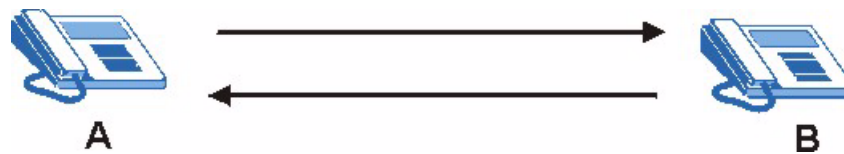
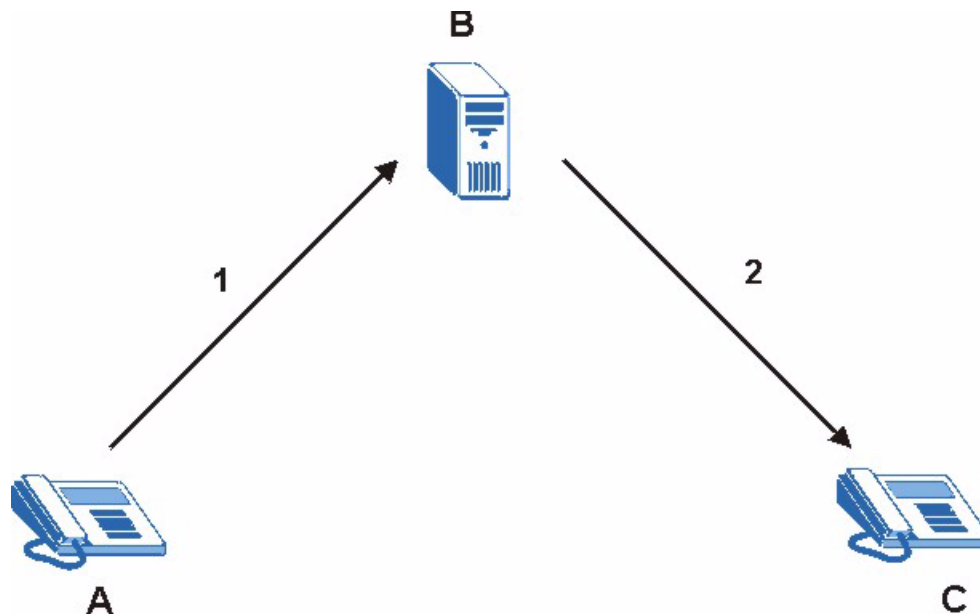

**Figure 68** SIP User Agent**9.1.5.2 SIP Proxy Server**

A SIP proxy server receives requests from clients and forwards them to another server.

In the following example, you want to use client device A to call someone who is using client device C.

- 1 The client device (A in the figure) sends a call invitation to the SIP proxy server (B).
- 2 The SIP proxy server forwards the call invitation to C.

**Figure 69** SIP Proxy Server**9.1.5.3 SIP Redirect Server**

A SIP redirect server accepts SIP requests, translates the destination address to an IP address and sends the translated IP address back to the device that sent the request. Then the client device that originally sent the request can send requests to the IP address that it received back from the redirect server. Redirect servers do not initiate SIP requests.

In the following example, you want to use client device A to call someone who is using client device C.

- 1 Client device A sends a call invitation for C to the SIP redirect server (B).
- 2 The SIP redirect server sends the invitation back to A with C's IP address (or domain name).
- 3 Client device A then sends the call invitation to client device C.

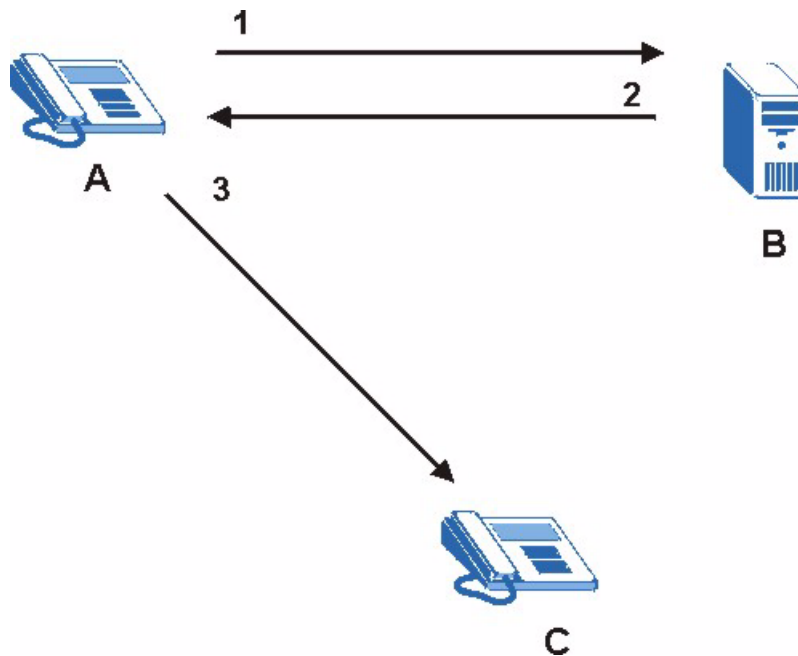
**Figure 70** SIP Redirect Server

#### 9.1.5.4 SIP Register Server

A SIP register server maintains a database of SIP identity-to-IP address (or domain name) mapping. The register server checks your user name and password when you register.

#### 9.1.6 RTP

When you make a VoIP call using SIP, the RTP (Real time Transport Protocol) is used to handle voice data transfer. See RFC 1889 for details on RTP.

#### 9.1.7 NAT and SIP

The ZyXEL Device must register its public IP address with a SIP register server. If there is a NAT router between the ZyXEL Device and the SIP register server, the ZyXEL Device probably has a private IP address. The ZyXEL Device lists its IP address in the SIP message that it sends to the SIP register server. NAT does not translate this IP address in the SIP message. The SIP register server gets the ZyXEL Device's IP address from inside the SIP message and maps it to your SIP identity. If the ZyXEL Device has a private IP address listed in the SIP message, the SIP server cannot map it to your SIP identity. See [Chapter 8 on page 117](#) for more information about NAT.

Use a SIP ALG (Application Layer Gateway), Use NAT, STUN, or outbound proxy to allow the ZyXEL Device to list its public IP address in the SIP messages.

##### 9.1.7.1 SIP ALG

See [Section 8.1.3 on page 119](#).

### 9.1.7.2 Use NAT

If you know the NAT router's public IP address and SIP port number, you can use the **Use NAT** feature to manually configure the ZyXEL Device to use a them in the SIP messages. This eliminates the need for STUN or a SIP ALG.

You must also configure the NAT router to forward traffic with this port number to the ZyXEL Device.

### 9.1.7.3 STUN

STUN (Simple Traversal of User Datagram Protocol (UDP) through Network Address Translators) allows the ZyXEL Device to find the presence and types of NAT routers and/or firewalls between it and the public Internet. STUN also allows the ZyXEL Device to find the public IP address that NAT assigned, so the ZyXEL Device can embed it in the SIP data stream. STUN does not work with symmetric NAT routers or firewalls. See RFC 3489 for details on STUN.

The following figure shows how STUN works.

- 1 The ZyXEL Device (A) sends SIP packets to the STUN server (B).
- 2 The STUN server (B) finds the public IP address and port number that the NAT router used on the ZyXEL Device's SIP packets and sends them to the ZyXEL Device.
- 3 The ZyXEL Device uses the public IP address and port number in the SIP packets that it sends to the SIP server (C).

**Figure 71** STUN

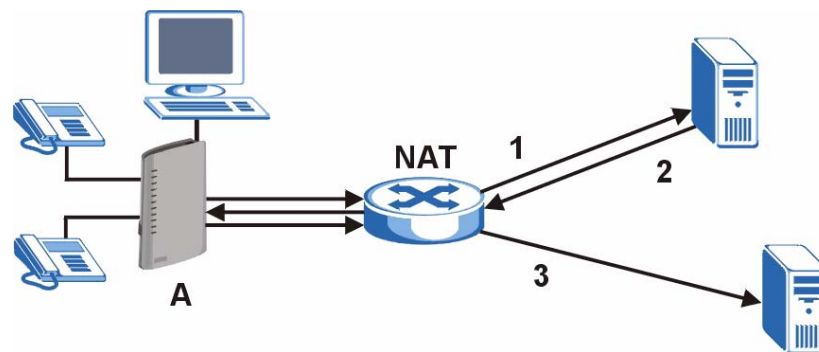

### 9.1.7.4 Outbound Proxy

Your VoIP service provider may host a SIP outbound proxy server to handle all of the ZyXEL Device's VoIP traffic. This allows the ZyXEL Device to work with any type of NAT router and eliminates the need for STUN or a SIP ALG. Turn off a SIP ALG on a NAT router in front of the ZyXEL Device to keep it from retranslating the IP address (since this is already handled by the outbound proxy server).

## 9.1.8 Voice Coding

A codec (coder/decoder) codes analog voice signals into digital signals and decodes the digital signals back into voice signals. The ZyXEL Device supports the following codecs.

- **G.711** is a Pulse Code Modulation (PCM) waveform codec. PCM measures analog signal amplitudes at regular time intervals and converts them into bits. G.711 provides very good sound quality but requires 64kbps of bandwidth.

- **G.729** is an Analysis-by-Synthesis (AbS) hybrid waveform codec that uses a filter based on information about how the human vocal tract produces sounds. G.729 provides good sound quality and reduces the required bandwidth to 8kbps.

### 9.1.9 PSTN Call Setup Signaling

PSTNs (Public Switched Telephone Networks) use DTMF or pulse dialing to set up telephone calls.

Dual-Tone Multi-Frequency (DTMF) signaling uses pairs of frequencies (one lower frequency and one higher frequency) to set up calls. It is also known as Touch Tone®. Each of the keys on a DTMF telephone corresponds to a different pair of frequencies.

Pulse dialing sends a series of clicks to the local phone office in order to dial numbers.<sup>1</sup>

### 9.1.10 MWI (Message Waiting Indication)

Enable Message Waiting Indication (MWI) enables your phone to give you a message-waiting (beeping) dial tone when you have one or more voice messages. Your VoIP service provider must have a messaging system that sends message-waiting-status SIP packets as defined in RFC 3842.

## 9.2 Custom Tones (IVR)

IVR (Interactive Voice Response) is a feature that allows you to use your telephone to interact with the ZyXEL Device. The ZyXEL Device allows you to record custom tones for the **Caller Ringing Tone** and **On Hold Tone** functions. The same recordings apply to both the caller ringing and on hold tones.

**Table 56** Custom Tones Details

LABEL	DESCRIPTION
Total Time for All Tones	127 seconds for all custom tones combined
Time per Individual Tone	20 seconds
Total Number of Tones Recordable	8 You can record up to 8 different custom tones but the total time must be 127 seconds or less.

#### 9.2.0.1 Recording Custom Tones

Use the following steps if you would like to create new tones or change your tones:

- 1 Pick up the phone and press “\*\*\*\*” on your phone’s keypad and wait for the message that says you are in the configuration menu.
- 2 Press a number from 1101~1108 on your phone followed by the “#” key.
- 3 Play your desired music or voice recording into the receiver’s mouthpiece. Press the “#” key.
- 4 You can continue to add, listen to, or delete tones, or you can hang up the receiver when you are done.

1. The ZyXEL Device supports DTMF at the time of writing.

### 9.2.0.2 Listening to Custom Tones

Do the following to listen to a custom tone:

- 1 Pick up the phone and press “\*\*\*\*” on your phone’s keypad and wait for the message that says you are in the configuration menu.
- 2 Press a number from 1201~1208 followed by the “#” key to listen to the tone.
- 3 You can continue to add, listen to, or delete tones, or you can hang up the receiver when you are done.

### 9.2.0.3 Deleting Custom Tones

Do the following to delete a custom tone:

- 1 Pick up the phone and press “\*\*\*\*” on your phone’s keypad and wait for the message that says you are in the configuration menu.
- 2 Press a number from 1301~1308 followed by the “#” key to delete the tone of your choice. Press 14 followed by the “#” key if you wish to clear all your custom tones.

You can continue to add, listen to, or delete tones, or you can hang up the receiver when you are done.

## 9.2.1 Quality of Service (QoS)

Quality of Service (QoS) refers to both a network's ability to deliver data with minimum delay and the networking methods used to provide bandwidth for real-time multimedia applications.

### 9.2.1.1 Type Of Service (ToS)

Network traffic can be classified by setting the ToS (Type Of Service) values at the data source (for example, at the ZyXEL Device) so a server can decide the best method of delivery, that is the least cost, fastest route and so on.

### 9.2.1.2 DiffServ

DiffServ is a class of service (CoS) model that marks packets so that they receive specific per-hop treatment at DiffServ-compliant network devices along the route based on the application types and traffic flow. Packets are marked with DiffServ Code Points (DSCPs) indicating the level of service desired. This allows the intermediary DiffServ-compliant network devices to handle the packets differently depending on the code points without the need to negotiate paths or remember state information for every flow. In addition, applications do not have to request a particular service or give advanced notice of where the traffic is going.<sup>1</sup>

### 9.2.1.3 DSCP and Per-Hop Behavior

DiffServ defines a new DS (Differentiated Services) field to replace the Type of Service (TOS) field in the IP header. The DS field contains a 2-bit unused field and a 6-bit DSCP field which can define up to 64 service levels. The following figure illustrates the DS field.

**Figure 72** DiffServ: Differentiated Service Field

DSCP (6-bit)	Unused (2-bit)
-----------------	-------------------

1. The ZyXEL Device does not support DiffServ at the time of writing.

DSCP is backward compatible with the three precedence bits in the ToS octet so that non-DiffServ compliant, ToS-enabled network device will not conflict with the DSCP mapping.

The DSCP value determines the forwarding behavior, the PHB (Per-Hop Behavior), that each packet gets across the DiffServ network. Based on the marking rule, different kinds of traffic can be marked for different priorities of forwarding. Resources can then be allocated according to the DSCP values and the configured policies.

#### 9.2.1.4 VLAN

Virtual Local Area Network (VLAN) allows a physical network to be partitioned into multiple logical networks. Only stations within the same group can communicate with each other.

Your ZyXEL Device can add IEEE 802.1Q VLAN ID tags to voice frames that it sends to the network. This allows the ZyXEL Device to communicate with a SIP server that is a member of the same VLAN group. Some ISPs use the VLAN tag to identify voice traffic and give it priority over other traffic.

## 9.3 SIP Screens

### 9.3.1 SIP Settings Screen

Use this screen to maintain basic information about each SIP account. Your VoIP service provider (the company that lets you make phone calls over the Internet) should provide this. You can also enable and disable each SIP account. To access this screen, click **VoIP > SIP > SIP Settings**.

**Figure 73** VoIP > SIP > SIP Settings

The screenshot displays the 'SIP Settings' configuration page. At the top, there are tabs for 'SIP Settings' and 'QoS'. Below the tabs, a dropdown menu shows 'SIP Account' set to 'SIP1'. The main content area is divided into two sections: 'SIP Settings' and 'Authentication'. In the 'SIP Settings' section, the 'Active SIP Account' checkbox is checked. The 'Number' field contains 'changeme'. The 'SIP Local Port' is set to 5060, with '(1025-65535)' in parentheses. The 'SIP Server Address' is 127.0.0.1, 'SIP Server Port' is 5060 (with '(1-65535)' in parentheses), 'REGISTER Server Address' is 127.0.0.1, 'REGISTER Server Port' is 5060 (with '(1-65535)' in parentheses), and 'SIP Service Domain' is 127.0.0.1. The 'Send Caller ID' checkbox is also checked. The 'Authentication' section has 'User Name' set to 'changeme' and 'Password' masked with asterisks. At the bottom, there are three buttons: 'Apply', 'Cancel', and 'Advanced Setup'.

Each field is described in the following table.

**Table 57** VoIP > SIP > SIP Settings

LABEL	DESCRIPTION
SIP Account	Select the SIP account you want to see in this screen. If you change this field, the screen automatically refreshes.
SIP Settings	
Active SIP Account	Select this if you want the ZyXEL Device to use this account. Clear it if you do not want the ZyXEL Device to use this account.
Number	Enter your SIP number. In the full SIP URI, this is the part before the @ symbol. You can use up to 127 printable ASCII characters.
SIP Local Port	Enter the ZyXEL Device's listening port number, if your VoIP service provider gave you one. Otherwise, keep the default value.
SIP Server Address	Enter the IP address or domain name of the SIP server provided by your VoIP service provider. You can use up to 95 printable ASCII characters. It does not matter whether the SIP server is a proxy, redirect or register server.
SIP Server Port	Enter the SIP server's listening port number, if your VoIP service provider gave you one. Otherwise, keep the default value.
REGISTER Server Address	Enter the IP address or domain name of the SIP register server, if your VoIP service provider gave you one. Otherwise, enter the same address you entered in the <b>SIP Server Address</b> field. You can use up to 95 printable ASCII characters.
REGISTER Server Port	Enter the SIP register server's listening port number, if your VoIP service provider gave you one. Otherwise, enter the same port number you entered in the <b>SIP Server Port</b> field.
SIP Service Domain	Enter the SIP service domain name. In the full SIP URI, this is the part after the @ symbol. You can use up to 127 printable ASCII Extended set characters.
Send Caller ID	Select this if you want to send identification when you make VoIP phone calls. Clear this if you do not want to send identification.
Authentication	
User Name	Enter the user name for registering this SIP account, exactly as it was given to you. You can use up to 95 printable ASCII characters.
Password	Enter the user name for registering this SIP account, exactly as it was given to you. You can use up to 95 printable ASCII Extended set characters.
Apply	Click this to save your changes and to apply them to the ZyXEL Device.
Cancel	Click this to set every field in this screen to its last-saved value.
Advanced Setup	Click this to edit the advanced settings for this SIP account. The <b>Advanced SIP Setup</b> screen appears.

### 9.3.2 Advanced SIP Setup Screen

Use this screen to maintain advanced settings for each SIP account. To access this screen, click **Advanced Setup** in **VoIP > SIP > SIP Settings**.

Figure 74 VoIP &gt; SIP &gt; SIP Settings &gt; Advanced

SIP Account : SIP1

**SIP Server Settings**

URL Type

Expiration Duration  (20-65535) sec

Register Re-send timer  (1-65535) sec

Session Expires  (30-3600) sec

Min-SE  (20-1800) sec

**RTP Port Range**

Start Port  (1025-65535)

End Port  (1025-65535)

**Voice Compression**

Primary Compression Type

Secondary Compression Type

Third Compression Type

DTMF Mode

**STUN**

Active

Server Address

Server Port  (1024-65535)

**Use NAT**

Active

Server Address

Server Port  (1024-65535)

**Outbound Proxy**

Active

Server Address

Server Port  (1024-65535)

**NAT Keep Alive**

Active

Keep Alive With SIP Proxy  Keep Alive With Outbound Proxy

Keep Alive Interval  (30-65535) sec

**MWI (Message Waiting Indication)**

Enable

Expiration Time  (1-65535) sec

**Fax Option**

G.711 Fax Passthrough  T.38 Fax Relay

**Call Forward**

Call Forward Table

**Caller Ringing**

Enable

Caller Ringing Tone

**On Hold**

Enable

On Hold Tone



Each field is described in the following table.

**Table 58** VoIP > SIP > SIP Settings > Advanced

LABEL	DESCRIPTION
SIP Account	This field displays the SIP account you see in this screen.
SIP Server Settings	
URL Type	Select whether or not to include the SIP service domain name when the ZyXEL Device sends the SIP number. <b>SIP</b> - include the SIP service domain name <b>TEL</b> - do not include the SIP service domain name
Expiration Duration	Enter the number of seconds your SIP account is registered with the SIP register server before it is deleted. The ZyXEL Device automatically tries to re-register your SIP account when one-half of this time has passed. (The SIP register server might have a different expiration.)
Register Re-send timer	Enter the number of seconds the ZyXEL Device waits before it tries again to register the SIP account, if the first try failed or if there is no response.
Session Expires	Enter the number of seconds the conversation can last before the call is automatically disconnected. Usually, when one-half of this time has passed, the ZyXEL Device or the other party updates this timer to prevent this from happening.
Min-SE	Enter the minimum number of seconds the ZyXEL Device accepts for a session expiration time when it receives a request to start a SIP session. If the request has a shorter time, the ZyXEL Device rejects it.
RTP Port Range	
Start Port End Port	Enter the listening port number(s) for RTP traffic, if your VoIP service provider gave you this information. Otherwise, keep the default values. To enter one port number, enter the port number in the <b>Start Port</b> and <b>End Port</b> fields. To enter a range of ports, <ul style="list-style-type: none"> <li>• enter the port number at the beginning of the range in the <b>Start Port</b> field</li> <li>• enter the port number at the end of the range in the <b>End Port</b> field.</li> </ul>
Voice Compression	Select the type of voice coder/decoder (codec) that you want the ZyXEL Device to use. G.711 provides higher voice quality but requires more bandwidth (64 kbps). <ul style="list-style-type: none"> <li>• <b>G.711A</b> is typically used in Europe.</li> <li>• <b>G.711u</b> is typically used in North America and Japan.</li> </ul> In contrast, <b>G.729</b> only requires 8 kbps. The ZyXEL Device must use the same codec as the peer. When two SIP devices start a SIP session, they must agree on a codec.
Primary Compression Type	Select the ZyXEL Device's first choice for voice coder/decoder.
Secondary Compression Type	Select the ZyXEL Device's second choice for voice coder/decoder. Select <b>None</b> if you only want the ZyXEL Device to accept the first choice.
Third Compression Type	This field is disabled if <b>Secondary Compression Type</b> is <b>None</b> . Select the ZyXEL Device's third choice for voice coder/decoder. Select <b>None</b> if you only want the ZyXEL Device to accept the first or second choice.

**Table 58** VoIP > SIP > SIP Settings > Advanced

LABEL	DESCRIPTION
DTMF Mode	<p>Control how the ZyXEL Device handles the tones that your telephone makes when you push its buttons. You should use the same mode your VoIP service provider uses.</p> <p><b>RFC 2833</b> - send the DTMF tones in RTP packets</p> <p><b>PCM</b> - send the DTMF tones in the voice data stream. This method works best when you are using a codec that does not use compression (like G.711). Codecs that use compression (like G.729) can distort the tones.</p> <p><b>SIP INFO</b> - send the DTMF tones in SIP messages</p>
STUN	
Active	<p>Select this if all of the following conditions are satisfied.</p> <ul style="list-style-type: none"> <li>• There is a NAT router between the ZyXEL Device and the SIP server.</li> <li>• The NAT router is not a SIP ALG.</li> <li>• Your VoIP service provider gave you an IP address or domain name for a STUN server.</li> </ul> <p>Otherwise, clear this field.</p>
Server Address	Enter the IP address or domain name of the STUN server provided by your VoIP service provider.
Server Port	Enter the STUN server's listening port, if your VoIP service provider gave you one. Otherwise, keep the default value.
Use NAT	
Active	Select this if you want the ZyXEL Device to send SIP traffic to a specific NAT router. You must also configure the NAT router to forward traffic with the specified port to the ZyXEL Device. This eliminates the need for STUN or a SIP ALG.
Server Address	Enter the public IP address or domain name of the NAT router.
Server Port	Enter the port number that your SIP sessions use with the public IP address of the NAT router.
Outbound Proxy	
Active	Select this if your VoIP service provider has a SIP outbound server to handle voice calls. This allows the ZyXEL Device to work with any type of NAT router and eliminates the need for STUN or a SIP ALG. Turn off any SIP ALG on a NAT router in front of the ZyXEL Device to keep it from retranslating the IP address (since this is already handled by the outbound proxy server).
Server Address	Enter the IP address or domain name of the SIP outbound proxy server.
Server Port	Enter the SIP outbound proxy server's listening port, if your VoIP service provider gave you one. Otherwise, keep the default value.
NAT Keep Alive	
Active	Select this to stop NAT routers between the ZyXEL Device and SIP server (a SIP proxy server or outbound proxy server) from dropping the SIP session. The ZyXEL Device does this by sending SIP notify messages to the SIP server based on the specified interval.
Keep Alive with SIP Proxy	Select this if the SIP server is a SIP proxy server.
Keep Alive with Outbound Proxy	Select this if the SIP server is an outbound proxy server. You must enable <b>Outbound Proxy</b> to use this.
Keep Alive Interval	Enter how often (in seconds) the ZyXEL Device should send SIP notify messages to the SIP server.
MWI (Message Waiting Indication)	

**Table 58** VoIP > SIP > SIP Settings > Advanced

LABEL	DESCRIPTION
Enable	Select this if you want to hear a waiting (beeping) dial tone on your phone when you have at least one voice message. Your VoIP service provider must support this feature.
Expiration Time	Keep the default value, unless your VoIP service provider tells you to change it. Enter the number of seconds the SIP server should provide the message waiting service each time the ZyXEL Device subscribes to the service. Before this time passes, the ZyXEL Device automatically subscribes again.
Fax Option	This field controls how the ZyXEL Device handles fax messages.
G.711 Fax Passthrough	Select this if the ZyXEL Device should use G.711 to send fax messages. The peer devices must also use G.711.
T.38 Fax Relay	Select this if the ZyXEL Device should send fax messages as UDP or TCP/IP packets through IP networks. This provides better quality, but it may have interoperability problems. The peer devices must also use T.38.
Call Forward	
Call Forward Table	Select which call forwarding table you want the ZyXEL Device to use for incoming calls. You set up these tables in <b>VoIP &gt; Phone Book &gt; Incoming Call Policy</b> .
Caller Ringing	
Enable	Select the check box if you want to specify what tone people hear when they call you. The ZyXEL Device provides a default tone, but you can add additional tones using IVR. See <a href="#">Section 9.2 on page 132</a> for more information.
Caller Ringing Tone	Select the tone you want people to hear when they call you. You should setup these tones using IVR first. See <a href="#">Section 9.2 on page 132</a> for more information.
On Hold	
Enable	Select the check box if you want to specify what tone people hear when you put them on hold. The ZyXEL Device provides a default tone, but you can add additional tones using IVR. See <a href="#">Section 9.2 on page 132</a> for more information.
On Hold Tone	Select the tone you want people to hear when you put them on hold. You should setup these tones using IVR first. See <a href="#">Section 9.2 on page 132</a> for more information.
<Back	Click this to return to the <b>SIP Settings</b> screen without saving your changes.
Apply	Click this to save your changes and to apply them to the ZyXEL Device.
Cancel	Click this to set every field in this screen to its last-saved value.

### 9.3.3 SIP QoS Screen

Use this screen to maintain ToS and VLAN settings for the ZyXEL Device. To access this screen, click **VoIP > SIP > QoS**.

**Figure 75** VoIP > SIP > QoS

Each field is described in the following table.

**Table 59** VoIP > SIP > QoS

LABEL	DESCRIPTION
SIP TOS Priority Setting	Enter the priority for SIP voice transmissions. The ZyXEL Device creates Type of Service priority tags with this priority to voice traffic that it transmits.
RTP TOS Priority Setting	Enter the priority for RTP voice transmissions. The ZyXEL Device creates Type of Service priority tags with this priority to RTP traffic that it transmits.
Voice VLAN ID	Select this if the ZyXEL Device has to be a member of a VLAN to communicate with the SIP server. Ask your network administrator, if you are not sure. Enter the VLAN ID provided by your network administrator in the field on the right. Your LAN and gateway must be configured to use VLAN tags. Otherwise, clear this field.
Apply	Click this to save your changes and to apply them to the ZyXEL Device.
Cancel	Click this to set every field in this screen to its last-saved value.

The following sections describe how to configure the ZyXEL Device to work with analog phones and how to configure the ZyXEL Device's built in DECT base station to work with DECT phones.

## 10.1 Analog Phone Overview

You can configure the volume, echo cancellation and VAD settings for each individual phone port on the ZyXEL Device. You can also select which SIP account to use for making outgoing calls.

### 10.1.1 Voice Activity Detection/Silence Suppression/Comfort Noise

Voice Activity Detection (VAD) detects whether or not speech is present. This lets the ZyXEL Device reduce the bandwidth that a call uses by not transmitting "silent packets" when you are not speaking.

When using VAD, the ZyXEL Device generates comfort noise when the other party is not speaking. The comfort noise lets you know that the line is still connected as total silence could easily be mistaken for a lost connection.

### 10.1.2 Echo Cancellation

G.168 is an ITU-T standard for eliminating the echo caused by the sound of your voice reverberating in the telephone receiver while you talk.

### 10.1.3 Supplementary Phone Services Overview

Supplementary services such as call hold, call waiting, call transfer, ... are generally available from your VoIP service provider. The ZyXEL Device supports the following services:

- Call Hold
- Call Waiting
- Making a Second Call
- Call Transfer
- Call Forwarding
- Three-Way Conference
- Internal Calls



**To take full advantage of the supplementary phone services available through the ZyXEL Device's phone ports, you may need to subscribe to the services from your VoIP service provider.**

### 10.1.3.1 The Flash Key

Flashing means to press the hook for a short period of time (a few hundred milliseconds) before releasing it. On newer telephones, there should be a "flash" key (button) that generates the signal electronically. If the flash key is not available, you can tap (press and immediately release) the hook by hand to achieve the same effect. However, using the flash key is preferred since the timing is much more precise. The ZyXEL Device may interpret manual tapping as hanging up if the duration is too long.

You can invoke all the supplementary services by using the flash key.

### 10.1.3.2 Europe Type Supplementary Phone Services

This section describes how to use supplementary phone services with the **Europe Type Call Service Mode**. Commands for supplementary services are listed in the table below.

After pressing the flash key, if you do not issue the sub-command before the default sub-command timeout (2 seconds) expires or issue an invalid sub-command, the current operation will be aborted.

**Table 60** European Type Flash Key Commands

COMMAND	SUB-COMMAND	DESCRIPTION
Flash		Put a current call on hold to place a second call. Switch back to the call (if there is no second call).
Flash	0	Drop the call presently on hold or reject an incoming call which is waiting for answer.
Flash	1	Disconnect the current phone connection and answer the incoming call or resume with caller presently on hold.
Flash	2	1. Switch back and forth between two calls. 2. Put a current call on hold to answer an incoming call. 3. Separate the current three-way conference call into two individual calls (one is on-line, the other is on hold).
Flash	3	Create three-way conference connection.
Flash	*98#	Transfer the call to another phone.

#### 10.1.3.2.1 European Call Hold

Call hold allows you to put a call (**A**) on hold by pressing the flash key.

If you have another call, press the flash key and then "2" to switch back and forth between caller **A** and **B** by putting either one on hold.

Press the flash key and then "0" to disconnect the call presently on hold and keep the current call on line.

Press the flash key and then "1" to disconnect the current call and resume the call on hold.

If you hang up the phone but a caller is still on hold, there will be a remind ring.

### 10.1.3.2.2 European Call Waiting

This allows you to place a call on hold while you answer another incoming call on the same telephone (directory) number.

If there is a second call to a telephone number, you will hear a call waiting tone. Take one of the following actions.

- Reject the second call.  
Press the flash key and then press “0”.
- Disconnect the first call and answer the second call.  
Either press the flash key and press “1”, or just hang up the phone and then answer the phone after it rings.
- Put the first call on hold and answer the second call.  
Press the flash key and then “2”.

### 10.1.3.2.3 European Call Transfer

Do the following to transfer an incoming call (that you have answered) to another phone.

- 1 Press the flash key to put the caller on hold.
- 2 When you hear the dial tone, dial “\*98#” followed by the number to which you want to transfer the call. to operate the Intercom.
- 3 After you hear the ring signal or the second party answers it, hang up the phone.

### 10.1.3.2.4 European Three-Way Conference

Use the following steps to make three-way conference calls.

- 1 When you are on the phone talking to someone, place the flash key to put the caller on hold and get a dial tone.
- 2 Dial a phone number directly to make another call.
- 3 When the second call is answered, press the flash key and press “3” to create a three-way conversation.
- 4 Hang up the phone to drop the connection.
- 5 If you want to separate the activated three-way conference into two individual connections (one is on-line, the other is on hold), press the flash key and press “2”.

### 10.1.3.3 USA Type Supplementary Services

This section describes how to use supplementary phone services with the **USA Type Call Service Mode**. Commands for supplementary services are listed in the table below.

After pressing the flash key, if you do not issue the sub-command before the default sub-command timeout (2 seconds) expires or issue an invalid sub-command, the current operation will be aborted.

**Table 61** USA Type Flash Key Commands

COMMAND	SUB-COMMAND	DESCRIPTION
Flash		Put a current call on hold to place a second call. After the second call is successful, press the flash key again to have a three-way conference call. Put a current call on hold to answer an incoming call.
Flash	*98#	Transfer the call to another phone.

#### 10.1.3.3.1 USA Call Hold

Call hold allows you to put a call (**A**) on hold by pressing the flash key.

If you have another call, press the flash key to switch back and forth between caller **A** and **B** by putting either one on hold.

If you hang up the phone but a caller is still on hold, there will be a remind ring.

#### 10.1.3.3.2 USA Call Waiting

This allows you to place a call on hold while you answer another incoming call on the same telephone (directory) number.

If there is a second call to your telephone number, you will hear a call waiting tone.

Press the flash key to put the first call on hold and answer the second call.

#### 10.1.3.3.3 USA Call Transfer

Do the following to transfer an incoming call (that you have answered) to another phone.

- 1 Press the flash key to put the caller on hold.
- 2 When you hear the dial tone, dial “\*98#” followed by the number to which you want to transfer the call. to operate the Intercom.
- 3 After you hear the ring signal or the second party answers it, hang up the phone.

#### 10.1.3.3.4 USA Three-Way Conference

Use the following steps to make three-way conference calls.

- 1 When you are on the phone talking to someone, place the flash key to put the caller on hold and get a dial tone.
- 2 Dial a phone number directly to make another call.
- 3 When the second call is answered, press the flash key, wait for the sub-command tone and press “3” to create a three-way conversation.
- 4 Hang up the phone to drop the connection.
- 5 If you want to separate the activated three-way conference into two individual connections (one is on-line, the other is on hold), press the flash key, wait for the sub-command tone and press “2”.

## 10.2 Phone Screens

### 10.2.1 Analog Phone Screen

Use this screen to control which SIP accounts and PSTN line each phone uses. To access this screen, click **VoIP > Phone > Analog Phone**.



**Figure 76** VoIP > Phone > Analog Phone

Each field is described in the following table.

**Table 62** VoIP > Phone > Analog Phone

LABEL	DESCRIPTION
Phone Port Settings	Select the phone port you want to see in this screen. If you change this field, the screen automatically refreshes.
Outgoing Call Use	
SIP1	Select this if you want this phone port to use the SIP1 account when it makes calls. If you select both SIP accounts, the ZyXEL Device tries to use the SIP account you registered most recently first.
SIP2	Select this if you want this phone port to use the SIP2 account when it makes calls. If you select both SIP accounts, the ZyXEL Device tries to use the SIP account you registered most recently first.
Incoming Call apply to	
SIP1	Select this if you want to receive phone calls for the SIP1 account on this phone port. If you select more than one source for incoming calls, there is no way to distinguish between them when you receive phone calls.
SIP2	Select this if you want to receive phone calls for the SIP2 account on this phone port. If you select more than one source for incoming calls, there is no way to distinguish between them when you receive phone calls.
PSTN Line	Select this if you want to receive phone calls from the PSTN line (that do not use the Internet) on this phone port. If you select more than one source for incoming calls, there is no way to distinguish between them when you receive phone calls.
Apply	Click this to save your changes and to apply them to the ZyXEL Device.
Cancel	Click this to set every field in this screen to its last-saved value.
Advanced Setup	Click this to edit the advanced settings for this phone port. The <b>Advanced Analog Phone Setup</b> screen appears.

## 10.2.2 Advanced Analog Phone Setup Screen

Use this screen to edit advanced settings for each phone port. To access this screen, click **Advanced Setup** in **VoIP > Phone > Analog Phone**.

**Figure 77** VoIP > Phone > Analog Phone > Advanced

Analog Phone 1

**Voice Volume Control**

Speaking Volume

Listening Volume

**Echo Cancellation**

G.168 Active

**Dialing Interval Select**

Dialing Interval Select

VAD Support

<Back Apply Cancel

Each field is described in the following table.

**Table 63** VoIP > Phone > Analog Phone > Advanced

LABEL	DESCRIPTION
Analog Phone	This field displays the phone port you see in this screen.
Voice Volume Control	
Speaking Volume	Enter the loudness that the ZyXEL Device uses for speech that it sends to the peer device. -1 is the quietest, and 1 is the loudest.
Listening Volume	Enter the loudness that the ZyXEL Device uses for speech that it receives from the peer device. -1 is the quietest, and 1 is the loudest.
Echo Cancellation	
G.168 Active	Select this if you want to eliminate the echo caused by the sound of your voice reverberating in the telephone receiver while you talk.
Dialing Interval Select	
Dialing Interval Select	Enter the number of seconds the ZyXEL Device should wait after you stop dialing numbers before it makes the phone call. The value depends on how quickly you dial phone numbers. If you select <b>Active Immediate Dial</b> in <b>VoIP &gt; Phone &gt; Common</b> , you can press the pound key (#) to tell the ZyXEL Device to make the phone call immediately, regardless of this setting.
VAD Support	Select this if the ZyXEL Device should stop transmitting when you are not speaking. This reduces the bandwidth the ZyXEL Device uses.
<Back	Click this to return to the <b>Analog Phone</b> screen without saving your changes.
Apply	Click this to save your changes and to apply them to the ZyXEL Device.
Cancel	Click this to set every field in this screen to its last-saved value.

## 10.3 DECT Base Station Overview

Your ZyXEL Device has a built in Digital Enhanced Cordless Telecommunications (DECT) base station. DECT is an ETSI (European Telecommunications Standards Institute) standard for digital cordless phones which specifies how they transmit, receive and process data and voice communication.

**Figure 78** DECT Base Station Overview

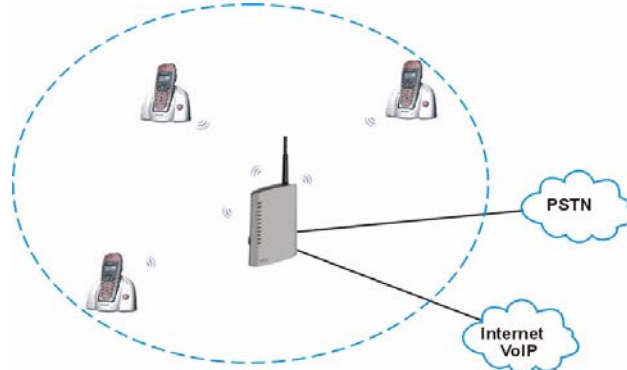

The DECT base station follows the Generic Access Profile (GAP). GAP (a subset of DECT) specifies how DECT phones register with a DECT base station. The DECT GAP standard ensures that two different products (a phone and a base station) from different manufacturers can work together. Any phone that supports GAP can make and receive calls through the ZyXEL Device.

### 10.3.1 DECT Phone Registration

In order to use your DECT phone with the ZyXEL Device, the DECT phone must register with the ZyXEL Device's DECT base station. Follow these steps to register your DECT phone with the ZyXEL Device.

- 1 Press down the DECT base station button (A) on top of your ZyXEL Device for 6 to 11 seconds to put the ZyXEL Device in registration mode.  
Registration mode refers to the state of the ZyXEL Device when it is scanning for DECT phones in its surrounding area. The ZyXEL Device stays in registration mode for 30 seconds.



**If you press the DECT base station button for 12 seconds or more, the DECT base station resets and all previously registered DECT phones must be re-registered.**

**Figure 79** DECT Base Station Button - Top of the ZyXEL Device

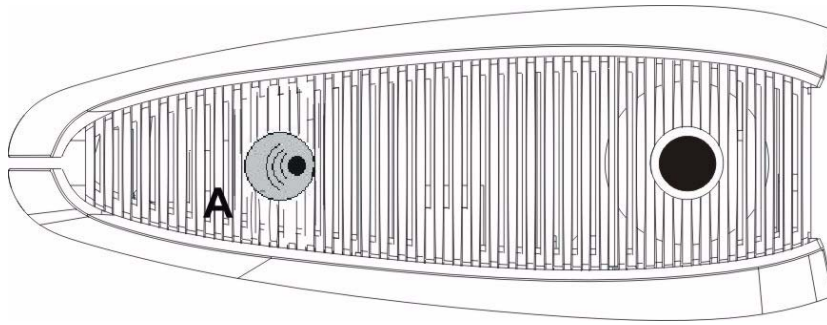

- 2 Put your DECT phone in registration mode. Refer to your DECT phone documentation. When the ZyXEL Device is in registration mode, it scans its surrounding area for DECT phones in registration mode.

**Figure 80** DECT Base Station - Phone Registration



---

**Make sure your DECT phone is within range of the ZyXEL Device during the registration process. See [Appendix A on page 287](#) for the range of your ZyXEL Device.**

---

- 3 Enter the Personal Identification Number (PIN) in the DECT phone. When a ZyXEL Device discovers a DECT phone in registration mode, it sends a request for a PIN. Your DECT phone receives the request and prompts you to enter the PIN. Use your DECT phone's keypad to enter the PIN (you configured on the ZyXEL Device).



---

**The default PIN of the ZyXEL Device is 1234.**

---

- 4 Repeat steps 1 - 3 to register additional phones. See [Appendix A on page 287](#) for the number of DECT phones your ZyXEL Device supports.

### 10.3.1.1 DECT Base Station Reset

Resetting the DECT base station erases all the details of the DECT phones registered with the ZyXEL Device. You can do this to clear the DECT base station memory of the DECT phones no longer used with the ZyXEL Device, for example if one of your DECT phones is lost.

When you reset the DECT base station, you will need to re-register all the phones that you want to use with the ZyXEL Device.



**Resetting the DECT base station does not reset the PIN you use for registering DECT phones. You must use the last PIN you configured to register or re-register your DECT phones.**

Press the DECT base station button (refer to [Figure 79 on page 148](#)) for 12 seconds or more to reset the DECT base station.

### 10.3.2 Using your DECT Phone

You can use your DECT phone to make calls to other DECT phones registered with the ZyXEL Device (A). These calls are referred to as internal calls.

You can also use your DECT phone to make VoIP calls (B). For the PSTN models, you can also make calls via the PSTN line (C). These types of calls are referred to as external calls.

**Figure 81** Using Your DECT Phone

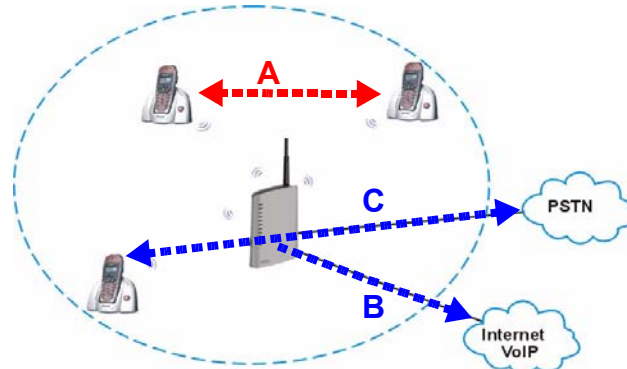

The following table summarizes the types and number of calls you can make with your DECT phones via the ZyXEL Device.

**Table 64** DECT Phone Calls Summary

TYPE OF CALL	DESCRIPTION	LIMITS
Internal	A call between two DECT phones registered with the ZyXEL Device DECT base station.	Two calls.
External	A call from the DECT phone to or from a VoIP or a PSTN caller.	Two calls.

**Table 64** DECT Phone Calls Summary

TYPE OF CALL	DESCRIPTION	LIMITS
3 Way Conference	A call between two DECT phones registered with the ZyXEL Device base station and an external connection.	One call.
The ZyXEL Device allows up to four DECT phones to be active at one time.		

The ZyXEL Device does not control how your DECT phone distinguishes between internal and external calls. Typically, a DECT phone has a button labeled **int** to indicate an internal call. Consult your DECT phone documentation for differences in making internal and external calls.

### 10.3.2.1 DECT Phones - Internal Calls

To make internal calls, you need to know the phone numbers of the other DECT phones registered with the ZyXEL Device. The ZyXEL Device assigns numbers based on the order that the DECT phones registered with the ZyXEL Device's DECT base station. The first DECT phone that registered with the ZyXEL Device's DECT base station receives the number **1**, the second the number **2**, and so on up to the last registered DECT phone.

Refer to your DECT phone documentation for specific details regarding your phone's calling functions.

### 10.3.2.2 DECT Phones - External Calls

To make external calls, follow the same procedure as with the analog phone connected to the ZyXEL Device. You must also:

- Specify the SIP accounts for incoming and outgoing VoIP calls.
- Specify whether the DECT phones should receive calls on the PSTN line. (P-2302HWUDL-P1 model only)

When you assign a specific SIP account to be used with the DECT phone for outgoing or incoming calls, all of the DECT phones registered with the ZyXEL Device use this SIP account for making or receiving calls.

### 10.3.2.3 DECT Phones - Supplementary Services

There are two ways to perform supplementary phone services like call waiting, conference calling and so on.

- Via the handset - refer to your DECT phone documentation.
- Via the flash key function - refer to [Section 10.1.3 on page 141](#). On most DECT phone models the flash key is the "R" key.

## 10.3.3 DECT Phone Screen

Use this screen to configure your DECT base station settings. To access this screen, click **VoIP > Phone > DECT Phone**.

**Figure 82** VoIP > Phone > DECT Phone

Each field is described in the following table.

**Table 65** VoIP > Phone > DECT Phone

LABEL	DESCRIPTION
Outgoing Call Use	If you select both SIP accounts, the ZyXEL Device tries to use the most recently registered SIP account first.
SIP1	Select this if you want to use the SIP1 account when making outgoing calls with your DECT phones.
SIP2	Select this if you want to use the SIP2 account when making calls with your DECT phones.
Incoming Call apply to	If you select more than one source for incoming calls, there is no way to distinguish between them when you receive phone calls.
SIP1	Select this if you want to receive phone calls for the SIP1 account on your DECT phones.
SIP2	Select this if you want to receive phone calls for the SIP2 account on your DECT phones.
PSTN Line	Select this if you want to receive phone calls from the PSTN line (that do not use the Internet) on your DECT phones. (P-2302HWUDL-P1 model only)
Base Station	
Update Register PIN Code	Select this to update the PIN code of the DECT phone. The default PIN code is <b>1234</b> . If you are changing the PIN code for the first time, enter <b>1234</b> in the <b>Old PIN Code</b> field.  <b>Note: When the PIN code changes, phones already registered with the ZyXEL Device will have to re-register when they are turned off and turned on again.</b>
Old PIN Code	Enter the existing PIN code. The PIN code can be from 1 to 4 digits long and is limited to numbers 0 to 9.
New PIN Code	Enter the new PIN code. The PIN code is 1 to 4 digits long and is limited to numbers 0 to 9.

**Table 65** VoIP > Phone > DECT Phone

LABEL	DESCRIPTION
Retype to Confirm	Retype the new PIN code.
Apply	Click this to save your changes and to apply them to the ZyXEL Device.
Cancel	Click this to set every field in this screen to its last-saved value.

### 10.3.4 Common Phone Settings Screen

Use this screen to activate and deactivate immediate dialing. To access this screen, click **VoIP > Phone > Common**.

**Figure 83** VoIP > Phone > Common

Each field is described in the following table.

**Table 66** VoIP > Phone > Common

LABEL	DESCRIPTION
Active Immediate Dial	Select this if you want to use the pound key (#) to tell the ZyXEL Device to make the phone call immediately, instead of waiting the number of seconds you selected in the <b>Dialing Interval Select</b> in <b>VoIP &gt; Phone &gt; Analog Phone</b> . If you select this, dial the phone number, and then press the pound key. The ZyXEL Device makes the call immediately, instead of waiting. You can still wait, if you want.
Apply	Click this to save your changes and to apply them to the ZyXEL Device.
Cancel	Click this to set every field in this screen to its last-saved value.

### 10.3.5 Phone Region Screen

Use this screen to maintain settings that often depend on which region of the world the ZyXEL Device is in. To access this screen, click **VoIP > Phone > Region**.

**Figure 84** VoIP > Phone > Region



Each field is described in the following table.

**Table 67** VoIP > Phone > Region

LABEL	DESCRIPTION
Region Settings	Select the place in which the ZyXEL Device is located. Do not select <b>Default</b> .
Call Service Mode	Select the mode for supplementary phone services (call hold, call waiting, call transfer and three-way conference calls) that your VoIP service provider supports. <b>Europe Type</b> - use supplementary phone services in European mode <b>USA Type</b> - use supplementary phone services American mode You might have to subscribe to these services to use them. Contact your VoIP service provider.
Apply	Click this to save your changes and to apply them to the ZyXEL Device.
Cancel	Click this to set every field in this screen to its last-saved value.



# Phone Book

Use these screens to maintain call-forwarding rules and speed-dial settings.

## 11.1 Phone Book Screens

### 11.1.1 Incoming Call Policy Screen

Use this screen to maintain rules for handling incoming calls. You can block, redirect, or accept them. To access this screen, click **VoIP > Phone Book > Incoming Call Policy**.

**Figure 85** VoIP > Phone Book > Incoming Call Policy

Table Number: Table 1

**Forward to Number Setup**

Unconditional Forward to Number

Busy Forward to Number

No Answer Forward to Number

No Answer Waiting Time: 5 (Second)

**Advanced Setup**

#	Activate	Incoming Call Number	Forward to Number	Condition
1	<input type="checkbox"/>	<span style="border: 1px solid black; display: inline-block; width: 150px; height: 15px;"></span>	<span style="border: 1px solid black; display: inline-block; width: 150px; height: 15px;"></span>	Unconditional ▾
2	<input type="checkbox"/>	<span style="border: 1px solid black; display: inline-block; width: 150px; height: 15px;"></span>	<span style="border: 1px solid black; display: inline-block; width: 150px; height: 15px;"></span>	Unconditional ▾
3	<input type="checkbox"/>	<span style="border: 1px solid black; display: inline-block; width: 150px; height: 15px;"></span>	<span style="border: 1px solid black; display: inline-block; width: 150px; height: 15px;"></span>	Unconditional ▾
4	<input type="checkbox"/>	<span style="border: 1px solid black; display: inline-block; width: 150px; height: 15px;"></span>	<span style="border: 1px solid black; display: inline-block; width: 150px; height: 15px;"></span>	Unconditional ▾
5	<input type="checkbox"/>	<span style="border: 1px solid black; display: inline-block; width: 150px; height: 15px;"></span>	<span style="border: 1px solid black; display: inline-block; width: 150px; height: 15px;"></span>	Unconditional ▾
6	<input type="checkbox"/>	<span style="border: 1px solid black; display: inline-block; width: 150px; height: 15px;"></span>	<span style="border: 1px solid black; display: inline-block; width: 150px; height: 15px;"></span>	Unconditional ▾
7	<input type="checkbox"/>	<span style="border: 1px solid black; display: inline-block; width: 150px; height: 15px;"></span>	<span style="border: 1px solid black; display: inline-block; width: 150px; height: 15px;"></span>	Unconditional ▾
8	<input type="checkbox"/>	<span style="border: 1px solid black; display: inline-block; width: 150px; height: 15px;"></span>	<span style="border: 1px solid black; display: inline-block; width: 150px; height: 15px;"></span>	Unconditional ▾
9	<input type="checkbox"/>	<span style="border: 1px solid black; display: inline-block; width: 150px; height: 15px;"></span>	<span style="border: 1px solid black; display: inline-block; width: 150px; height: 15px;"></span>	Unconditional ▾
10	<input type="checkbox"/>	<span style="border: 1px solid black; display: inline-block; width: 150px; height: 15px;"></span>	<span style="border: 1px solid black; display: inline-block; width: 150px; height: 15px;"></span>	Unconditional ▾

Apply
Cancel

You can create two sets of call-forwarding rules. Each one is stored in a call-forwarding table. Each field is described in the following table.

**Table 68** VoIP > Phone Book > Incoming Call Policy

LABEL	DESCRIPTION
Table Number	Select the call-forwarding table you want to see in this screen. If you change this field, the screen automatically refreshes.
Forward to Number Setup	The ZyXEL Device checks these rules, in the order in which they appear, after it checks the rules in the <b>Advanced Setup</b> section.
Unconditional Forward to Number	Select this if you want the ZyXEL Device to forward all incoming calls to the specified phone number, regardless of other rules in the <b>Forward to Number</b> section. Specify the phone number in the field on the right.
Busy Forward to Number	Select this if you want the ZyXEL Device to forward incoming calls to the specified phone number if the phone port is busy. Specify the phone number in the field on the right. If you have call waiting, the incoming call is forwarded to the specified phone number if you reject or ignore the second incoming call.
No Answer Forward to Number	Select this if you want the ZyXEL Device to forward incoming calls to the specified phone number if the call is unanswered. (See <b>No Answer Waiting Time</b> .) Specify the phone number in the field on the right.
No Answer Waiting Time	This field is used by the <b>No Answer Forward to Number</b> feature and <b>No Answer</b> conditions below. Enter the number of seconds the ZyXEL Device should wait for you to answer an incoming call before it considers the call is unanswered.
Advanced Setup	The ZyXEL Device checks these rules before it checks the rules in the <b>Forward to Number</b> section.
#	This field is a sequential value, and it is not associated with a specific rule. The sequence is important, however. The ZyXEL Device checks each rule in order, and it only follows the first one that applies.
Activate	Select this to enable this rule. Clear this to disable this rule.
Incoming Call Number	Enter the phone number to which this rule applies.
Forward to Number	Enter the phone number to which you want to forward incoming calls from the <b>Incoming Call Number</b> . You may leave this field blank, depending on the <b>Condition</b> .
Condition	Select the situations in which you want to forward incoming calls from the <b>Incoming Call Number</b> , or select an alternative action. <b>Unconditional</b> - The ZyXEL Device immediately forwards any calls from the <b>Incoming Call Number</b> to the <b>Forward to Number</b> . <b>Busy</b> - The ZyXEL Device forwards any calls from the <b>Incoming Call Number</b> to the <b>Forward to Number</b> when your SIP account already has a call connected. <b>No Answer</b> - The ZyXEL Device forwards any calls from the <b>Incoming Call Number</b> to the <b>Forward to Number</b> when the call is unanswered. (See <b>No Answer Waiting Time</b> .) <b>Block</b> - The ZyXEL Device rejects calls from the <b>Incoming Call Number</b> . <b>Accept</b> - The ZyXEL Device allows calls from the <b>Incoming Call Number</b> . You might create a rule with this condition if you do not want incoming calls from someone to be forwarded by rules in the <b>Forward to Number</b> section.
Apply	Click this to save your changes and to apply them to the ZyXEL Device.
Cancel	Click this to set every field in this screen to its last-saved value.

## 11.1.2 Speed Dial Screen

Speed dial provides shortcuts for dialing frequently used (VoIP) phone numbers. You also have to create speed-dial entries if you want to make peer-to-peer calls or call SIP numbers that use letters. Use this screen to add, edit, or remove speed-dial entries. To access this screen, click **VoIP > Phone Book > Speed Dial**.

In peer-to-peer calls, you call another VoIP device directly without going through a SIP server. In the ZyXEL Device, you must set up a speed dial entry in the phone book in order to do this. Select **Non-Proxy (Use IP or URL)** in the **Type** column and enter the callee's IP address or domain name. The ZyXEL Device sends SIP INVITE requests to the peer VoIP device when you use the speed dial entry.

You do not need to configure a SIP account in order to make a peer-to-peer VoIP call.

You can also create speed-dial entries for frequently-used SIP phone numbers. VoIP > Phone

Book > Speed Dial

Each field is described in the following table.

**Table 69** VoIP > Phone Book > Speed Dial

LABEL	DESCRIPTION
Speed Dial	Use this section to create or edit speed-dial entries.
Speed Dial	Select the speed-dial number you want to use for this phone number.
Number	Enter the SIP number you want the ZyXEL Device to call when you dial the speed-dial number.
Name	Enter a name to identify the party you call when you dial the speed-dial number. You can use up to 127 printable ASCII characters.

**Table 69** VoIP > Phone Book > Speed Dial

LABEL	DESCRIPTION
Type	<p>Select <b>Use Proxy</b> if you want to use one of your SIP accounts to call this phone number.</p> <p>Select <b>Non-Proxy (Use IP or URL)</b> if you want to use a different SIP server or if you want to make a peer-to-peer call. In this case, enter the IP address or domain name of the SIP server or the other party in the field below.</p>
Add	Click this to use the information in the <b>Speed Dial</b> section to update the <b>Speed Dial Phone Book</b> section.
Speed Dial Phone Book	Use this section to look at all the speed-dial entries and to erase them.
Speed Dial	This field displays the speed-dial number you should dial to use this entry. You should dial the numbers the way they appear in the screen.
Number	This field displays the SIP number the ZyXEL Device calls when you dial the speed-dial number.
Name	This field displays the name of the party you call when you dial the speed-dial number.
Destination	This field is blank, if the speed-dial entry uses one of your SIP accounts. Otherwise, this field shows the IP address or domain name of the SIP server or other party. (This field corresponds with the <b>Type</b> field in the <b>Speed Dial</b> section.)
Modify	<p>Use this field to edit or erase the speed-dial entry.</p> <p>Click the <b>Edit</b> icon to copy the information for this speed-dial entry into the <b>Speed Dial</b> section, where you can change it.</p> <p>Click the <b>Remove</b> icon to erase this speed-dial entry.</p>
Clear	Click this to erase all the speed-dial entries.
Cancel	Click this to set every field in this screen to its last-saved value.

## PSTN Line

This chapter applies to “L” models only. Use this screen to set up the PSTN line used to make regular phone calls. These phone calls do not use the Internet.

### 12.1 PSTN Line Overview

With the Public Switched Telephone Network (PSTN) line, you can make and receive regular phone calls. Use a prefix number to make a regular call. When the ZyXEL Device does not have power, you can make regular calls without dialing a prefix number.

You can also specify phone numbers that should always use the regular phone service (without having to dial a prefix number). Do this for emergency numbers (like those for contacting police, fire or emergency medical services).



---

**When the ZyXEL Device does not have power, only the phone connected to the PHONE 1 port can be used for making calls. Ensure you know which phone this is, so that in case of emergency you can make outgoing calls.**

---

### 12.2 PSTN Line Screen

Use this screen to set up the PSTN line you use to make regular phone calls. To access this screen, click **VoIP > PSTN Line > General**.

**Figure 86** VoIP > PSTN Line > General

**General**

**Call through PSTN Line**

PSTN Line Pre-fix Number

Relay to PSTN Line

1.
2.
3.
4.
5.
6.
7.
8.
9.

Each field is described in the following table.

**Table 70** VoIP > PSTN Line > General

LABEL	DESCRIPTION
PSTN Line Pre-fix Number	Enter 1 - 7 telephone keys (0 - 9, #, *) you dial before you dial the phone number, if you want to make a regular phone call while one of your SIP accounts is registered. These numbers tell the ZyXEL Device that you want to make a regular phone call. It is not recommended to use the # key, however, because it is also used in <b>Immediate Dial</b> . (See <b>VoIP &gt; Phone &gt; Common</b> .)
Relay to PSTN Line	Enter phone numbers (for regular calls, not VoIP calls) that you want to dial without the prefix number. For example, you should enter emergency numbers. The number (1 - 9) is not a speed-dial number. It is just a sequential value that is not associated with any phone number.
Apply	Click this to save your changes and to apply them to the ZyXEL Device.
Cancel	Click this to set every field in this screen to its last-saved value.



# VoIP Trunking

Use these screens to configure VoIP trunking on your ZyXEL Device.

## 13.1 VoIP Trunking Overview

VoIP trunking connects an IP network (like the Internet) and the Public Switched Telephone Network (PSTN). PSTN includes the world's circuit-switched telephone network which is composed of fixed and mobile telephones. VoIP trunking allows you to create VoIP links which PSTN (Public Switched Telephone Network) callers can use to:

- Make phone calls via the Internet - Make a PSTN call to the ZyXEL Device and it forwards the call to any SIP based VoIP phone.
- Save on long distance calls - The ZyXEL Device creates a VoIP link which can be used to connect to a PSTN phone in another country, province, region and so on.

Similarly, VoIP callers can:

- Make calls to PSTN subscribers at reduced cost - Connect to the ZyXEL Device via VoIP and the ZyXEL Device forwards the call to a PSTN phone.

Creating a link over the IP network requires two VoIP devices. VoIP trunking scenarios vary depending on how the VoIP devices work together and how they receive or forward PSTN calls. The following sections describe the details of VoIP trunking.

## 13.2 VoIP Trunking and Security

Your ZyXEL Device provides two types of authentication to prevent unauthorized callers from using it for VoIP trunking.

### 13.2.1 Auto Attendant and Authentication

Auto attendant is the ZyXEL Device's name for a service which controls settings specific to VoIP trunking. Most importantly it controls authentication for VoIP trunking. Auto attendant authentication is similar to using a calling card with a PIN (Personal Identification Number). Your ZyXEL Device can be configured so that it prompts callers to enter a PIN (via the phone pad) in order to process any call forwarding requests.

Other settings controlled by the auto attendant include a time limit to decide whether you want to forward a call from the ZyXEL Device or call the phone directly connected to the ZyXEL Device. When you call into your ZyXEL Device you can request to forward a call to another phone number simply by dialing that number. If you don't dial any number within a specified time limit (for example 5 seconds) then the phone directly connected to the ZyXEL Device rings. It also controls the time limit you have between dialing digits of a phone number.

## 13.2.2 Peer Call Authentication

VoIP devices can make peer calls to each other by using the IP address instead of a SIP number to establish a call. The advantage of this is that you do not need to pay a VoIP service provider. VoIP devices that connect using an IP address are referred to here as peer devices. A local peer device is where the VoIP call originates and a remote peer device is where the VoIP call ends. In the following figure, local peer device (A) connects to a remote peer device (B) via the IP address of B.

**Figure 87** Peer Devices Connecting



A peer-to-peer call doesn't require any authentication, however, authentication is required when you request the remote peer device to forward a call. The remote peer device has a list of accounts, each consisting of a username and password, which are allowed to use the remote peer device to forward calls. These accounts make up an incoming authentication list.

The local peer device has a corresponding list of outgoing authentication accounts. These accounts consist of the IP address of a remote peer device, the port number to communicate over as well as a username and password to use for authentication. An outgoing authentication account must match an incoming authentication account's username and password in order for the remote device to forward calls. The following table shows example entries for incoming and outgoing authentication. The bolded entries must match in order for authentication between two peer devices to occur.

**Table 71** Matching Incoming and Outgoing Authentication

ACCOUNT DETAILS	LOCAL PEER DEVICE	REMOTE PEER DEVICE
Outgoing Authentication		
Username	localDeviceA	localDeviceB
Password	passwordA	passwordB
Incoming Authentication		
Username	userone	localDeviceA
Password	userpassword	passwordA

## 13.3 Call Rules

Call rules automate the forwarding of calls, first to a remote peer device and then to PSTN phones. This is used when you make frequent calls to several PSTN numbers in the same geographic area that start with the same numbers (for example an area code). If there is a remote peer device in that area, you can set up a VoIP link to it and have it forward the calls to PSTN phones. This works by configuring a pattern that the ZyXEL Device can recognize. A pattern is just the initial string of digits shared by the phone numbers. The following table shows the relationship between the phone numbers you want to call, the pattern you want to configure and the rule you want to set up.

**Table 72** Call Rules

FREQUENTLY CALLED PSTN NUMBERS	PATTERN	CALL RULE
1-555-555-4321 1-555-544-5678 1-555-432-8888	1555	Set up a peer call to a remote peer device to forward calls starting with the numbers 1555.
1-111-555-4321 1-111-544-5678 1-111-432-8888	1111	Set up a peer call to a remote peer device to forward calls starting with the numbers 1111.

## 13.4 VoIP Trunking Scenarios

There are several different VoIP trunking scenarios.

### 13.4.1 VoIP Phone To PSTN Phone

A VoIP phone **A** makes a call to the ZyXEL Device **B** via VoIP. **B** forwards the call to a PSTN phone **C**. **A** can be an analog phone connected to the ZyXEL Device or any other phone capable of making calls over the IP network.

**Figure 88** VoIP Phone To PSTN Phone

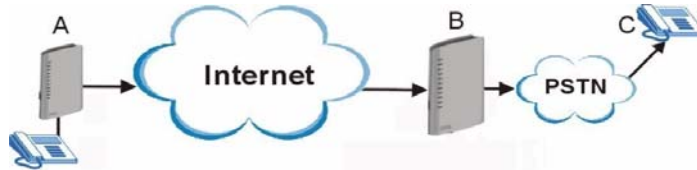

### 13.4.2 PSTN Phone To VoIP Phone

A PSTN phone **A** makes a call to the ZyXEL Device **B**. **B** connects **A** to a VoIP phone **C** over the IP network.

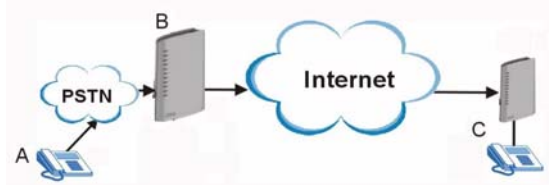
**Figure 89** PSTN Phone To VoIP Phone

### 13.4.3 PSTN Phone To PSTN Phone via VoIP

A PSTN phone **A** makes a call to the ZyXEL Device **B**. **B** connects to a peer device **C** and **C** forwards the call to a PSTN phone **D**.

**Figure 90** PSTN Phone To PSTN Phone via VoIP

## 13.5 Trunking General Screen

Use this screen to enable VoIP trunking, click [VoIP > Trunking > General](#).



**VoIP Trunking requires the following additional configuration in the VoIP > SIP > SIP Settings > Advanced Setup screen: Voice Compression field needs to be set to G.729 and DTMF Mode field needs to be set to SIP INFO.**

**Figure 91** VoIP > Trunking > General

The screenshot shows the 'General' tab of the VoIP > Trunking > General configuration screen. The 'General' tab is selected, and there are also 'Peer Call' and 'Call Rule' tabs. The configuration options are as follows:

- Enable Trunking
- Auto Attendant Timeout(sec):
- Dialing Interval(sec):
- Enable Auto Attendant Authentication
- Password:

At the bottom of the screen, there are 'Apply' and 'Cancel' buttons.

Each field is described in the following table.

**Table 73** [VoIP > Trunking > General](#)

LABEL	DESCRIPTION
Enable Trunking	Select this to turn on VoIP trunking on your ZyXEL Device.
Auto Attendant Timeout(sec)	This is the setting which determines how long the ZyXEL Device waits for a caller to enter a phone number when it receives the call. Enter the number of seconds before the Auto Attendant times out. The default value is 10 seconds and entering 0 does not change the default. Enter a value from 1 to 255 seconds. When the auto attendant times out, the phone directly connected to the ZyXEL Device rings.
Dialing Interval(sec)	Enter the number of seconds the ZyXEL Device should wait after you stop dialing numbers before it makes the phone call. The value depends on how quickly you dial phone numbers. The default value is 3 seconds and entering 0 does not change the default. Enter a value from 1 to 255 seconds.
Enable Auto Attendant Authentication	Select this to enable authentication for calls coming into your ZyXEL Device. This is similar to enabling a PIN (Personal Identification Number) that callers must enter to forward calls via your ZyXEL Device.
Password	This is the PIN callers have to enter via their phone pad when dialing into your ZyXEL Device to forward calls through it. Enter a number between 1 and 32 digits long.
Apply	Click this to save your changes and to apply them to the ZyXEL Device.
Cancel	Click this to reset the fields.

## 13.6 Trunking Peer Call Screen

Use this screen to set up outgoing authentication accounts for forwarding calls through peer devices and incoming authentication accounts for forwarding calls from peer devices. To access this screen, click [VoIP > Trunking > Peer Call](#).

**Figure 92** VoIP > Trunking > Peer Call

The screenshot shows the configuration interface for VoIP Trunking Peer Call. It features three tabs: 'General', 'Peer Call', and 'Call Rule'. The 'Peer Call' tab is selected. The interface is divided into two main sections: 'Outgoing Authentication' and 'Incoming Authentication'.

**Outgoing Authentication Table:**

#	Name	Username	Password	Peer IP	Peer Port
1				0.0.0.0	5060
2				0.0.0.0	5060
3				0.0.0.0	5060
4				0.0.0.0	5060
5				0.0.0.0	5060
6				0.0.0.0	5060
7				0.0.0.0	5060
8				0.0.0.0	5060
9				0.0.0.0	5060
10				0.0.0.0	5060

**Incoming Authentication Table:**

#	Username	Password
1		
2		
3		
4		
5		
6		
7		
8		
9		
10		

At the bottom of the page, there are 'Apply' and 'Cancel' buttons.

Each field is described in the following table.

**Table 74** VoIP > Trunking > Peer Call

LABEL	DESCRIPTION
Outgoing Authentication	You need to set up accounts for the peer devices you use in VoIP trunking. This is the IP address of the remote peer device, as well as the username and password needed to authenticate with the remote peer device.
#	This is an index number of your outgoing authentication accounts.
Name	Enter a descriptive name for the remote peer device of this account. For example, if the peer device is located in London, you might enter <b>London</b> as the account name. This name is used when you configure call rules in the <b>VoIP &gt; Trunking &gt; Call Rules</b> screen.
Username	Enter the username needed to authenticate at the remote peer device. The remote peer device must have the same username in an incoming authentication entry in order to authenticate your connection. Enter up to 32 alphanumeric characters.

**Table 74** VoIP > Trunking > Peer Call (continued)

LABEL	DESCRIPTION
Password	Enter the corresponding password for the username you entered. The remote peer device must have the same password in an incoming authentication entry in order to authenticate your connection. Enter up to 32 alphanumeric characters.
Peer IP	Enter the IP address of the remote peer device which you want to connect to.
Peer Port	Enter the port number through which your ZyXEL Device will connect to the remote peer device. The default value is the standard port for VoIP communication. Do not change this value unless the remote peer device does not follow the standard.
Incoming Authentication	You can set up multiple accounts which are allowed to use your ZyXEL Device for VoIP trunking. When peer devices want to forward calls through your ZyXEL Device, this is the list your ZyXEL Device checks to see if the user has the right to complete the call.
#	This is the index number of the incoming authentication accounts.
Username	Enter a username for the account. This username is used to authenticate peer devices forwarding calls through the ZyXEL Device. Enter up to 32 alphanumeric characters.
Password	Enter the password for the corresponding username. This password is used to authenticate peer devices calling the ZyXEL Device. Enter up to 32 alphanumeric characters.
Apply	Click this to apply your settings to the ZyXEL Device.
Cancel	Click this to reset the fields to their last saved values.

## 13.7 Trunking Call Rule Screen

Use this screen to set up rules that determine which peer VoIP device your call will be forwarded to. To access this screen, click [VoIP > Trunking > Call Rule](#).

**Figure 93** VoIP > Trunking > Call Rule

#	Pattern	Account
1	<input type="text"/>	None
2	<input type="text"/>	None
3	<input type="text"/>	None
4	<input type="text"/>	None
5	<input type="text"/>	None
6	<input type="text"/>	None
7	<input type="text"/>	None
8	<input type="text"/>	None
9	<input type="text"/>	None
10	<input type="text"/>	None
11	<input type="text"/>	None
12	<input type="text"/>	None
13	<input type="text"/>	None
14	<input type="text"/>	None
15	<input type="text"/>	None
16	<input type="text"/>	None
17	<input type="text"/>	None
18	<input type="text"/>	None
19	<input type="text"/>	None
20	<input type="text"/>	None

Each field is described in the following table.

**Table 75** VoIP > Trunking > Call Rule

LABEL	DESCRIPTION
#	This is a read-only index number of the call rules.
Pattern	<p>A <b>Pattern</b> is used when you call your ZyXEL Device from a PSTN phone and want to use it to create a VoIP link to a remote peer device which will forward the call to a PSTN phone.</p> <p>A <b>Pattern</b> is a string of digits your ZyXEL Device uses to determine whether or not to send the call to a peer VoIP device. For example, if you want to use trunking to call phone numbers which start with the number “555”, then enter 555 in this field. Enter up to 32 numeric characters.</p> <p>If the number you dial does not match any of the patterns you configured, then you can still use your ZyXEL Device to forward calls to VoIP phones. Simply dial the SIP number of the VoIP phone you want to call.</p>
Account	<p>Select the outgoing authentication account you set up in the <b>Peer Call</b> screen. This account is used to direct your call to the correct remote peer device and to authenticate you.</p> <p>Select <b>None</b> to disable this forwarding rule.</p>
Apply	Click this to apply your settings to the ZyXEL Device.
Cancel	Click this to reset the fields.



## 13.8 VoIP Trunking Example: VoIP to PSTN

This example shows how to configure VoIP to PSTN trunking to save on long distance calls.

### 13.8.1 Background Information

A company has its headquarters in city A and a branch office in city B. The headquarters often needs to call salespeople employed at the branch office. The sales employees often work away from the office and have PSTN phones (mobile or land based). The two offices have VoIP trunking devices and want to use VoIP trunking to save on calls from the headquarters to their sales team. The head office has a public IP address **a.b.c.d** and the branch office has a public IP address **w.x.y.z**.

**Figure 94** VoIP to PSTN Example

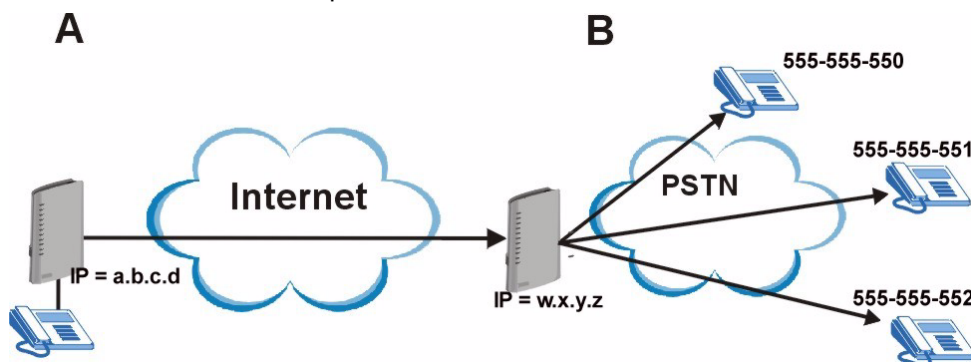

The proposed solution is to establish a peer-to-peer call between the two ZyXEL Devices and have the branch office ZyXEL Device forward calls to the sales team members via PSTN.

### 13.8.2 Configuration Details: Outgoing

The ZyXEL Device (at headquarters) from which the call originates needs to have the following configuration settings:

- 1 Speed dial entries need to be set up for the numbers headquarters wants to call. The destination field of these entries is the IP address of the branch office ZyXEL Device. This must be a non-proxy IP address. The numbers are the phone numbers of the sales team members. This can be configured in the **VoIP > Phone Book > Speed Dial** screen.

**Figure 95** VoIP to PSTN Example - Speed Dial Screen

Speed Dial	Number	Name:	Destination	Modify
#01	55555550	Sales1	w.x.y.z	
#02	55555551	Sales2	w.x.y.z	
#03	55555552	Sales3	w.x.y.z	
#04				
#05				
#06				
#07				
#08				
#09				
#10				

- An outgoing authentication account needs to be configured. This account consists of the IP address and port number of the branch office ZyXEL Device as well as the username and password for authentication. This username and password must match the incoming authentication account username and password on the branch office ZyXEL Device. The name of this rule is “CityB” referring to the branch office ZyXEL Device. In this example the username is “headquarters” and the password is “password”. This can be configured in the **VoIP > Trunking > Peer Call** screen.

**Figure 96** VoIP to PSTN Example - Outgoing Authentication

#	Name	Username	Password	Peer IP	Peer Port
1	CityB	headquarters	*****	w.x.y.z	5060
2				0.0.0.0	5060
3				0.0.0.0	5060
4				0.0.0.0	5060
5				0.0.0.0	5060
6				0.0.0.0	5060
7				0.0.0.0	5060
8				0.0.0.0	5060
9				0.0.0.0	5060
10				0.0.0.0	5060

### 13.8.3 Configuration Details: Incoming

The branch office ZyXEL Device needs to have an incoming authentication account configured. This consists of a username and password. This account must match the username and password of the outgoing authentication account of the headquarters' ZyXEL Device. This can be configured in the **VoIP > Trunking > Peer Call** screen.

**Figure 97** VoIP to PSTN Example - Incoming Authentication

Outgoing Authentication					
#	Name	Username	Password	Peer IP	Peer Port
1				0.0.0.0	5060
2				0.0.0.0	5060
3				0.0.0.0	5060
4				0.0.0.0	5060
5				0.0.0.0	5060
6				0.0.0.0	5060
7				0.0.0.0	5060
8				0.0.0.0	5060
9				0.0.0.0	5060
10				0.0.0.0	5060

Incoming Authentication		
#	Username	Password
1	headquarters	*****
2		

### 13.8.4 Call Progression

The advantage of this kind of VoIP trunking is that once all the configuration is completed, the caller just has to dial a speed dial entry from a phone connected to their ZyXEL Device and the peer devices take care of the rest. This is what happens when headquarters wants to call their **Sales1** employee, which is the first entry in the speed dial screen.

**Table 76** VoIP Trunking Call Progression

HEADQUARTERS	BRANCH OFFICE	SALES1
A person at <b>A</b> dials #01 from the phone connected to the ZyXEL Device.		
The ZyXEL Device at <b>A</b> inspects the number and connects to the remote peer device at <b>B</b> .	→	
The remote peer device inspects the number and requests authentication in order to forward the call.	←	
The ZyXEL Device at <b>A</b> sends outgoing authentication to the remote peer device.	→	
The remote peer device confirms that the username and password match an account in its incoming authentication list.	←	
	The remote peer device forwards the call to <b>Sales1</b> .	→
<b>Sales1</b> picks up and the call commences. <div style="text-align: center;">←→</div>		

## 13.9 VoIP Trunking Example: PSTN to PSTN via VoIP

This example shows how to configure a PSTN to PSTN call with a VoIP link. It also shows how call rules can be used to automate VoIP trunking.

### 13.9.1 Background Information

A company has its headquarters in two different cities. The sales manager (**A**) from headquarters often needs to call salespeople (**D**) employed at the branch office. The sales manager often works away from the headquarters office and the sales employees often work away from the branch office. The sales manager and the sales employees have PSTN phones (mobile or land based). The two offices have VoIP trunking devices. The sales manager wants to use VoIP trunking to save on calls to his sales team. The head office has a ZyXEL Device (**B**) with a PSTN line (tel: 222-222-2222) connected to it. The branch office has a ZyXEL Device (**C**) with a public IP address **w.x.y.z**. The sales employee (**D**) has a PSTN phone with the number 555-555-4321.

**Figure 98** PSTN to PSTN Example

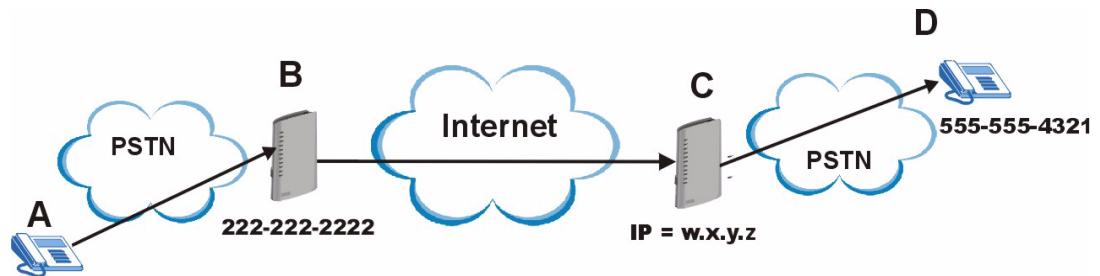

The proposed solution is to configure a call rule which will allow the sales manager to call into the headquarters via PSTN, establish a VoIP link between the two ZyXEL Devices and have the remote peer device forward calls to the sales employees via PSTN.

### 13.9.2 Configuration Details: Outgoing

The ZyXEL Device (at headquarters) from which the VoIP link originates needs to have the following configuration settings:

- 1 Auto attendant authentication needs to be enabled for PSTN calls coming into the headquarters' ZyXEL Device. This ensures that no unauthorized callers use VoIP trunking. In this example the PIN (Personal Identification Number) is set to "12345". The settings dealing with dialing interval and a timeout period are left at default. The ZyXEL Device waits 10 seconds (after initial connection between PSTN caller and the ZyXEL Device) for the PSTN caller to initiate VoIP trunking by dialing another number. It waits 3 seconds between dialing digits before it determines that the entire phone number is entered. These settings can be configured in the **VoIP > Trunking > General** screen.

**Figure 99** PSTN to PSTN Example: General Configuration

General Peer Call Call Rule

Enable Trunking

Auto Attendant Timeout(sec) 10

Dialing Interval(sec) 3

Enable Auto Attendant Authentication

Password 12345

Apply Cancel

- An outgoing authentication account needs to be configured. This account consists of the IP address and port number of the branch office ZyXEL Device as well as the username and password for authentication. This username and password must match the incoming authentication account username and password on the branch office ZyXEL Device. The name of this account is “CityB” referring to the branch office ZyXEL Device. In this example the username is “headquarters” and the password is “password”. This can be configured in the **VoIP > Trunking > Peer Call** screen.

**Figure 100** PSTN to PSTN Example - Outgoing Authentication

#	Name	Username	Password	Peer IP	Peer Port
1	CityB	headquarters	*****	w.x.y.z	5060
2				0.0.0.0	5060
3				0.0.0.0	5060
4				0.0.0.0	5060
5				0.0.0.0	5060
6				0.0.0.0	5060
7				0.0.0.0	5060
8				0.0.0.0	5060
9				0.0.0.0	5060
10				0.0.0.0	5060

- A call rule needs to be created. This rule tells the ZyXEL Device which remote peer device it should connect to in order to complete the call. This rule is composed of a pattern and an account name. This pattern is simply the first several digits of the number you want the remote device to connect to. In this example this is the first 4 digits (“5555”) of “Sales1” telephone number. The account name is the name of the outgoing authentication account created in the **Speed Dial** screen (“CityB”). This setting can be configured in the **VoIP > Trunking > Call Rule** screen.

**Figure 101** PSTN to PSTN Example - Call Rule

Peer Call Outgoing Table			
#	Pattern		Account
1	5555		CityB
2			None
3			None
4			None
5			None
6			None
7			None
8			None
9			None

### 13.9.3 Configuration Details: Incoming

The branch office ZyXEL Device needs to have an incoming authentication account configured. This consists of a username and password. This account must match the username and password of the outgoing authentication account of the headquarters' ZyXEL Device. This can be configured in the **VoIP > Trunking > Peer Call** screen.

**Figure 102** PSTN to PSTN Example - Incoming Authentication

Outgoing Authentication					
#	Name	Username	Password	Peer IP	Peer Port
1				0.0.0.0	5060
2				0.0.0.0	5060
3				0.0.0.0	5060
9				0.0.0.0	5060
10				0.0.0.0	5060











  

Incoming Authentication		
#	Username	Password
1	headquarters	*****
2		

## 13.9.4 Call Progression

The call is initiated by the manager dialing into the headquarter's ZyXEL Device via PSTN. In this scenario a VoIP link is established between headquarters and the branch office and then the call is forwarded to **Sales1** using PSTN.

**Table 77** PSTN to PSTN: VoIP Trunking Call Progression

MANAGER	HEADQUARTERS	BRANCH OFFICE	SALES1
	The manager dials the PSTN number of the headquarters' ZyXEL Device. <b>(222-222-2222)</b> 		
	The ZyXEL Device receives the call and sends a ringback alert tone to the caller that VoIP trunking is enabled. 		
	The manager dials the PSTN number of <b>Sales1 (555-555-1234)</b> . 		
	The ZyXEL Device prompts the manager to enter the PIN in order to allow VoIP trunking. 		
	The manager dials the PIN <b>(12345)</b> . 		
	The ZyXEL Device confirms the password and allows for VoIP trunking. The ZyXEL Device inspects the phone number against call rules. Since the number starts with the pattern <b>(5555)</b> , it uses the account <b>(CityB)</b> associated with this pattern to connect the call to the remote peer device at the branch office. 		
	The remote peer device inspects the number and requests authentication in order to forward the call. 		
	The ZyXEL Device at <b>A</b> sends outgoing authentication to the remote peer device. 		
	The remote peer device confirms that the username and password match an account in its incoming authentication list.		
		The remote peer device forwards the call to <b>Sales1</b> . 	
<b>Sales1</b> picks up and the call commences. 			





---

# PART IV

## Security

---

Firewall (179)

Content Filter (187)



# Firewall

Use these screens to enable, configure and disable the firewall that protects your ZyXEL Device and your LAN from unwanted or malicious traffic.

## 14.1 Firewall Overview

Originally, the term *firewall* referred to a construction technique designed to prevent the spread of fire from one room to another. The networking term "firewall" is a system or group of systems that enforces an access-control policy between two networks. It may also be defined as a mechanism used to protect a trusted network from an untrusted network. Of course, firewalls cannot solve every security problem. A firewall is one of the mechanisms used to establish a network security perimeter in support of a network security policy. It should never be the only mechanism or method employed. For a firewall to guard effectively, you must design and deploy it appropriately. This requires integrating the firewall into a broad information-security policy. In addition, specific policies must be implemented within the firewall itself.

### 14.1.1 Stateful Inspection Firewall.

Stateful inspection firewalls restrict access by screening data packets against defined access rules. They make access control decisions based on IP address and protocol. They also "inspect" the session data to assure the integrity of the connection and to adapt to dynamic protocols. These firewalls generally provide the best speed and transparency; however, they may lack the granular application level access control or caching that some proxies support. Firewalls, of one type or another, have become an integral part of standard security solutions for enterprises.

### 14.1.2 About the ZyXEL Device Firewall

The ZyXEL Device firewall is a stateful inspection firewall and is designed to protect against Denial of Service attacks when activated. The ZyXEL Device's purpose is to allow a private Local Area Network (LAN) to be securely connected to the Internet. The ZyXEL Device can be used to prevent theft, destruction and modification of data, as well as log events, which may be important to the security of your network.

The ZyXEL Device is installed between the LAN and a broadband modem connecting to the Internet. This allows it to act as a secure gateway for all data passing between the Internet and the LAN.

The ZyXEL Device has one Ethernet WAN port and four Ethernet LAN ports, which are used to physically separate the network into two areas. The WAN (Wide Area Network) port attaches to the broadband (cable or DSL) modem to the Internet.

The LAN (Local Area Network) port attaches to a network of computers, which needs security from the outside world. These computers will have access to Internet services such as e-mail, FTP and the World Wide Web. However, "inbound access" is not allowed (by default) unless the remote host is authorized to use a specific service.

### 14.1.3 Guidelines For Enhancing Security With Your Firewall

- 1 Change the default password via web configurator.
- 2 Think about access control before you connect to the network in any way, including attaching a modem to the port.
- 3 Limit who can access your router.
- 4 Don't enable any local service (such as telnet or FTP) that you don't use. Any enabled service could present a potential security risk. A determined hacker might be able to find creative ways to misuse the enabled services to access the firewall or the network.
- 5 For local services that are enabled, protect against misuse. Protect by configuring the services to communicate only with specific peers, and protect by configuring rules to block packets for the services at specific interfaces.
- 6 Protect against IP spoofing by making sure the firewall is active.
- 7 Keep the firewall in a secured (locked) room.

### 14.1.4 The Firewall, NAT and Remote Management

Figure 103 Firewall Rule Directions

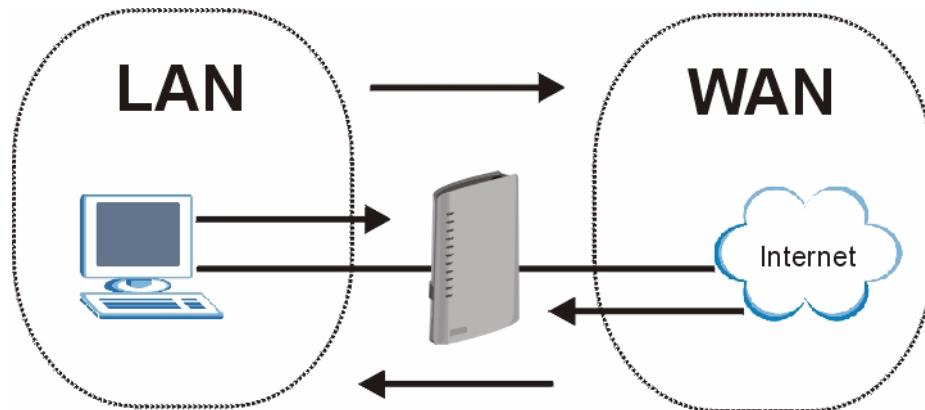

#### 14.1.4.1 LAN-to-WAN rules

**LAN-to-WAN** rules are local network to Internet firewall rules. The default is to forward all traffic from your local network to the Internet.

You can block certain **LAN-to-WAN** traffic in the **Services** screen (click the **Services** tab). All services displayed in the **Blocked Services** list box are **LAN-to-WAN** firewall rules that block those services originating from the LAN.

Blocked **LAN-to-WAN** packets are considered alerts. Alerts are “higher priority logs” that include system errors, attacks and attempted access to blocked web sites. Alerts appear in red in the **View Log** screen. You may choose to have alerts e-mailed immediately in the **Log Settings** screen.

LAN-to-LAN/ZyXEL Device means the LAN to the ZyXEL Device LAN interface. This is always allowed, as this is how you manage the ZyXEL Device from your local computer.

#### 14.1.4.2 WAN-to-LAN rules

**WAN-to-LAN** rules are Internet to your local network firewall rules. The default is to block all traffic from the Internet to your local network.

How can you forward certain WAN to LAN traffic? You may allow traffic originating from the WAN to be forwarded to the LAN by:

- Configuring NAT port forwarding rules.
- Configuring **WAN** or **LAN & WAN** access for services in the **Remote Management** screens. When you allow remote management from the WAN, you are actually configuring WAN-to-WAN/ZyXEL Device firewall rules. WAN-to-WAN/ZyXEL Device firewall rules are Internet to the ZyXEL Device WAN interface firewall rules. The default is to block all such traffic. When you decide what WAN-to-LAN packets to log, you are in fact deciding what **WAN-to-LAN** and WAN-to-WAN/ZyXEL Device packets to log.

Forwarded **WAN-to-LAN** packets are not considered alerts.

## 14.2 Triangle Route

When the firewall is on, your ZyXEL Device acts as a secure gateway between your LAN and the Internet. In an ideal network topology, all incoming and outgoing network traffic passes through the ZyXEL Device to protect your LAN against attacks.

**Figure 104** Ideal Firewall Setup

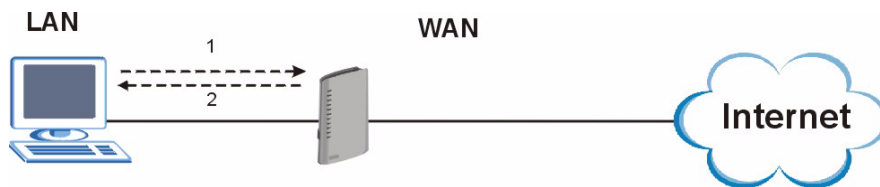

### 14.2.1 The “Triangle Route” Problem

A traffic route is a path for sending or receiving data packets between two Ethernet devices. You may have more than one connection to the Internet (through one or more ISPs). If an alternate gateway is on the LAN (and its IP address is in the same subnet as the ZyXEL Device’s LAN IP address), the “triangle route” (also called asymmetrical route) problem may occur. The steps below describe the “triangle route” problem.

- 1 A computer on the LAN initiates a connection by sending out a SYN packet to a receiving server on the WAN.

- 2 The ZyXEL Device reroutes the SYN packet through Gateway A on the LAN to the WAN.
- 3 The reply from the WAN goes directly to the computer on the LAN without going through the ZyXEL Device.

As a result, the ZyXEL Device resets the connection, as the connection has not been acknowledged.

**Figure 105** “Triangle Route” Problem

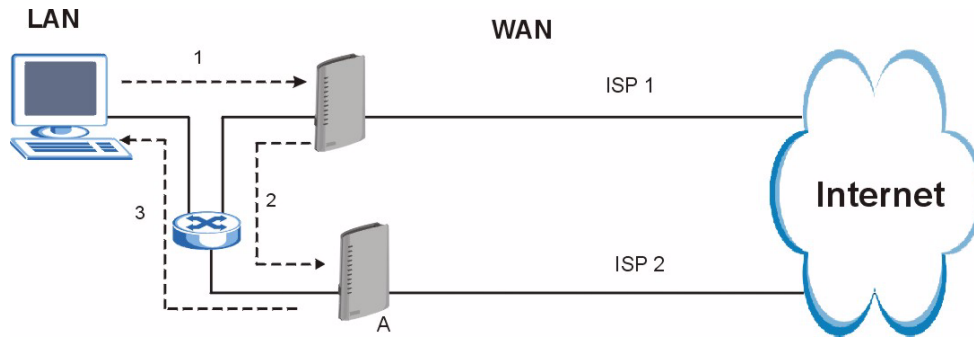

## 14.2.2 Solving the “Triangle Route” Problem

If you have the ZyXEL Device allow triangle route sessions, traffic from the WAN can go directly to a LAN computer without passing through the ZyXEL Device and its firewall protection.

Another solution is to use IP alias. IP alias allows you to partition your network into logical sections over the same Ethernet interface. Your ZyXEL Device supports up to three logical LAN interfaces with the ZyXEL Device being the gateway for each logical network.

It’s like having multiple LAN networks that actually use the same physical cables and ports. By putting your LAN and Gateway A in different subnets, all returning network traffic must pass through the ZyXEL Device to your LAN. The following steps describe such a scenario.

- 1 A computer on the LAN initiates a connection by sending a SYN packet to a receiving server on the WAN.
- 2 The ZyXEL Device reroutes the packet to Gateway A, which is in Subnet 2.
- 3 The reply from the WAN goes to the ZyXEL Device.
- 4 The ZyXEL Device then sends it to the computer on the LAN in Subnet 1.

Figure 106 IP Alias

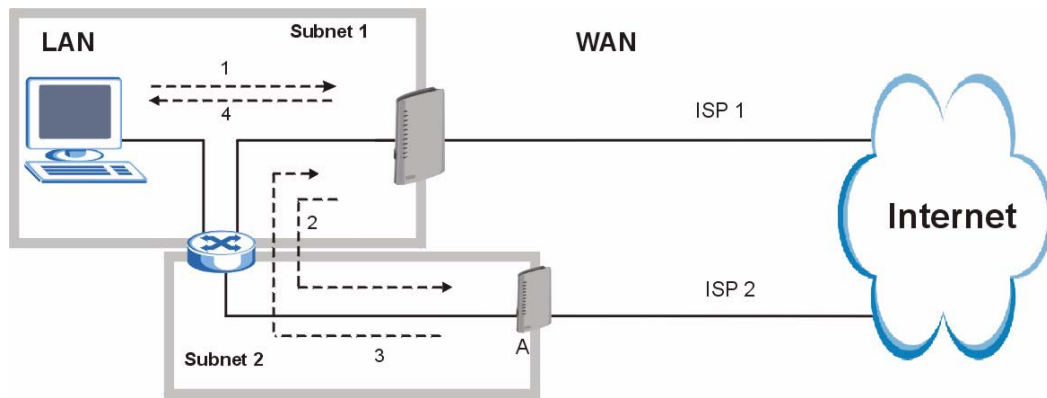

## 14.3 Firewall Screens

### 14.3.1 General Firewall Screen

Use this screen to configure the basic settings for your firewall. To access this screen, click **Security > Firewall > General**.

Figure 107 Security &gt; Firewall &gt; General

Packet Direction	Log
LAN to WAN	No Log
WAN to LAN	No Log

Each field is described in the following table.

Table 78 Security &gt; Firewall &gt; General

LABEL	DESCRIPTION
Enable Firewall	Select this to activate the firewall. The ZyXEL Device controls access and protects against Denial of Service (DoS) attacks when the firewall is activated.
Bypass Triangle Route	Select this if you want to let some traffic from the WAN go directly to a computer in the LAN without passing through the ZyXEL Device. See the appendices for more information about triangle route topology.
Max NAT/Firewall Session Per User	Select the maximum number of NAT rules and firewall rules the ZyXEL Device enforces at one time. The ZyXEL Device automatically allocates memory for the maximum number of rules, regardless of whether or not there is a rule to enforce. This is the same number you enter in <b>Network &gt; NAT &gt; General</b> .

**Table 78** Security > Firewall > General

LABEL	DESCRIPTION
Packet Direction	This field displays each direction that packets pass through the ZyXEL Device.
Log	Select the situations in which you want to create log entries for firewall events. <b>No Log</b> - do not create any log entries <b>Log Blocked</b> - (LAN to WAN only) create log entries when packets are blocked <b>Log Forwarded</b> - (WAN to LAN only) create log entries when packets are forwarded <b>Log All</b> - create log entries for every packet
Apply	Click this to save your changes and to apply them to the ZyXEL Device.
Cancel	Click this to set every field in this screen to its last-saved value.

### 14.3.2 Firewall Services Screen

Use this screen to enable service blocking, to set up the date and time service blocking is effective, and to maintain the list of services you want to block. To access this screen, click **Security > Firewall > Services**.

**Figure 108** Security > Firewall > Services

The screenshot shows the 'Services' configuration screen. It has two tabs: 'General' and 'Services'. The 'Services' tab is active. The screen is divided into two main sections: 'Service Setup' and 'Schedule to Block'.

**Service Setup:**

- Enable Services Blocking
- Available Services list: Custom Port..., Any(TCP), Any(UDP), IPSEC\_TUNNEL(ESP:0), MULTICAST(IGMP:0), PING(ICMP:0), PPTP\_TUNNEL(GRE:0), BGP(TCP:179)
- Blocked Services list: (empty)
- Text: Select "Custom Port", you can give new port range for blocking
- Type: TCP (dropdown)
- Port Number: 0 ~ 0 (input fields)
- Buttons: Add, Delete, Clear All

**Schedule to Block:**

- Day to Block:
  - Everyday
  - Sun  Mon  Tue  Wed  Thu  Fri  Sat
- Time of Day to Block (24-Hour Format):
  - All day
  - From: Start 0 (hour) 0 (min) End 0 (hour) 0 (min)
- Buttons: Apply, Cancel

Each field is described in the following table.

**Table 79** Security > Firewall > Services

LABEL	DESCRIPTION
Service Setup	
Enable Services Blocking	Select this to activate service blocking. The <b>Schedule to Block</b> section controls what days and what times service blocking is actually effective, however.



**Table 79** Security > Firewall > Services

LABEL	DESCRIPTION
Available Services	<p>This is a list of pre-defined services (destination ports) you may prohibit your LAN computers from using. Select the port you want to block, and click <b>Add</b> to add the port to the <b>Blocked Services</b> field.</p> <p>A custom port is a service that is not available in the pre-defined <b>Available Services</b> list. You must define it using the <b>Type</b> and <b>Port Number</b> fields. See <a href="#">Appendix G on page 339</a> for some examples of services.</p>
Blocked Services	<p>This is a list of services (ports) that are inaccessible to computers on your LAN when service blocking is effective. To remove a service from this list, select the service, and click <b>Delete</b>.</p>
Type	<p>Select <b>TCP</b> or <b>UDP</b>, based on which one the custom port uses.</p>
Port Number	<p>Enter the range of port numbers that defines the service. For example, suppose you want to define the Gnutella service. Select <b>TCP</b> type and enter a port range of <b>6345-6349</b>.</p>
Add	<p>Click this to add the selected service in <b>Available Services</b> to the <b>Blocked Services</b> list.</p>
Delete	<p>Select a service in the <b>Blocked Services</b>, and click this to remove the service from the list.</p>
Clear All	<p>Click this to remove all the services in the <b>Blocked Services</b> list.</p>
Schedule to Block	
Day to Block	<p>Select which days of the week you want the service blocking to be effective.</p>
Time of Day to Block	<p>Select what time each day you want service blocking to be effective. Select <b>All day</b> to always block the selected services. Enter times in 24-hour format; for example, 3:00pm should be entered as 15:00.</p>
Apply	<p>Click this to save your changes and to apply them to the ZyXEL Device.</p>
Cancel	<p>Click this to set every field in this screen to its last-saved value.</p>



# Content Filter

Use these screens to create and enforce policies that restrict access to the Internet based on content.

## 15.1 Content Filtering Overview

Internet content filtering allows you to create and enforce Internet access policies tailored to their needs. Content filtering is the ability to block certain web features or specific URL keywords.

The ZyXEL Device can block web features such as ActiveX controls, Java applets, cookies and disable web proxies. The ZyXEL Device also allows you to define time periods and days during which the ZyXEL Device performs content filtering.

## 15.2 Content Filtering Screens

### 15.2.1 Content Filter Screen

Use this screen to set up a trusted IP address, which web features are restricted, and which keywords are blocked when content filtering is effective. To access this screen, click **Security > Content Filter > Filter**.

**Figure 109** Security > Content Filter > Filter

Each field is described in the following table.

**Table 80** Security > Content Filter > Filter

LABEL	DESCRIPTION
Trusted IP Setup	
Trusted Computer IP Address	You can allow a specific computer to access all Internet resources without the restrictions you set in these screens. Enter the IP address of the trusted computer.
Restrict Web Features	Select the web features you want to disable. If a user downloads a page with a restricted feature, that part of the web page appears blank or grayed out. <b>ActiveX</b> - This is a tool for building dynamic and active Web pages and distributed object applications. When you visit an ActiveX Web site, ActiveX controls are downloaded to your browser, where they remain in case you visit the site again. <b>Java</b> - This is used to build downloadable Web components or Internet and intranet business applications of all kinds. <b>Cookies</b> - This is used by Web servers to track usage and to provide service based on ID. <b>Web Proxy</b> - This is a server that acts as an intermediary between a user and the Internet to provide security, administrative control, and caching service. When a proxy server is located on the WAN, it is possible for LAN users to avoid content filtering restrictions.
Keyword Blocking	
Enable URL Keyword Blocking	Select this if you want the ZyXEL Device to block Web sites based on words in the web site address. For example, if you block the keyword <b>bad</b> , <a href="http://www.website.com/bad.html">http://www.website.com/bad.html</a> is blocked.
Keyword	Type a keyword you want to block in this field. You can use up to 64 printable ASCII characters. There is no wildcard character, however.
Add	Click this to add the specified <b>Keyword</b> to the <b>Keyword List</b> . You can enter up to 64 keywords.

**Table 80** Security > Content Filter > Filter

LABEL	DESCRIPTION
Keyword List	This field displays the keywords that are blocked when <b>Enable URL Keyword Blocking</b> is selected. To delete a keyword, select it, click <b>Delete</b> , and click <b>Apply</b> .
Delete	Click <b>Delete</b> to remove the selected keyword in the <b>Keyword List</b> . The keyword disappears after you click <b>Apply</b> .
Clear All	Click this button to remove all of the keywords in the <b>Keyword List</b> .
Denied Access Message	Enter the message that is displayed when the ZyXEL Device's content filter feature blocks access to a web site.
Apply	Click this to save your changes and to apply them to the ZyXEL Device.
Cancel	Click this to set every field in this screen to its last-saved value.

## 15.2.2 Content Filter Schedule Screen

Use this screen to set up the schedule when content filtering is effective. To access this screen, click **Security > Content Filter > Schedule**.

**Figure 110** Security > Content Filter > Schedule

Each field is described in the following table.

**Table 81** Security > Content Filter > Schedule

LABEL	DESCRIPTION
Day to Block	Select which days of the week you want content filtering to be effective.
Time of Day to Block	Select what time each day you want content filtering to be effective. Enter times in 24-hour format; for example, 3:00pm should be entered as 15:00.
Apply	Click this to save your changes and to apply them to the ZyXEL Device.
Cancel	Click this to set every field in this screen to its last-saved value.



---

# PART V

# Management

---

Static Route (193)  
Bandwidth MGMT (197)  
Remote MGMT (209)  
UPnP (217)  
Sharing a USB Printer (229)  
File Sharing (243)





# Static Route

Use these screens to configure static routes in the ZyXEL Device.

## 16.1 Static Route Overview

Each remote node specifies only the network to which the gateway is directly connected, and the ZyXEL Device has no knowledge of the networks beyond. For instance, the ZyXEL Device knows about network N2 in the following figure through remote node Router 1. However, the ZyXEL Device is unable to route a packet to network N3 because it doesn't know that there is a route through the same remote node Router 1 (via gateway Router 2). The static routes are for you to tell the ZyXEL Device about the networks beyond the remote nodes.

**Figure 111** Example of Static Routing Topology

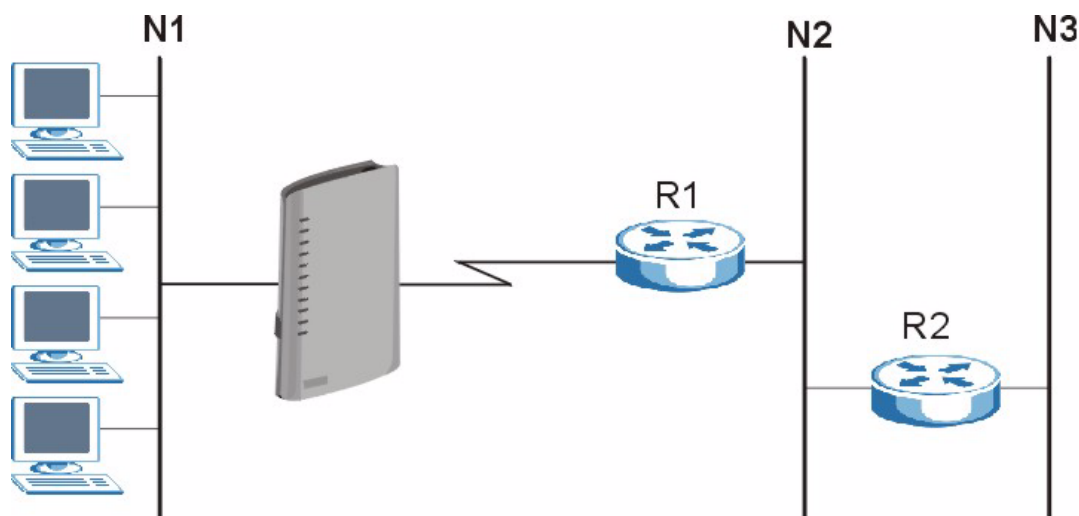

## 16.2 Static Route Screens

### 16.2.1 IP Static Route Screen

Use this screen to look at static routes in the ZyXEL Device. To access this screen, click **Management > Static Route > IP Static Route**.



The first static route is the default route and cannot be modified or deleted.

Figure 112 Management > Static Route > IP Static Route

IP Static Route					
Static Route Rules					
#	Name	Active	Destination	Gateway	Modify
1	-	-	...	...	
2	-	-	...	...	
3	-	-	...	...	
4	-	-	...	...	
5	-	-	...	...	
6	-	-	...	...	
7	-	-	...	...	
8	-	-	...	...	

Each field is described in the following table.

Table 82 Management > Static Route > IP Static Route

LABEL	DESCRIPTION
#	This field is a sequential value, and it is not associated with a specific rule. The sequence is important, however. The ZyXEL Device checks each rule in order, and it only follows the first one that applies.
Name	This field displays the name that describes the static route.
Active	This field shows whether this static route is active ( <b>Yes</b> ) or not ( <b>No</b> ).
Destination	This field displays the destination IP address(es) that this static route affects.
Gateway	This field displays the IP address of the gateway to which the ZyXEL Device should send packets for the specified <b>Destination</b> . The gateway is a router or a switch on the same network segment as the device's LAN or WAN port. The gateway helps forward packets to their destinations.
Modify	Use this field to edit or erase the static route. Click the <b>Edit</b> icon to open the <b>IP Static Route Edit</b> screen for this static route. Click the <b>Remove</b> icon to erase this static route.

## 16.2.2 IP Static Route Edit Screen

Use this screen to edit a static route in the ZyXEL Device. To access this screen, click an **Edit** icon in **Management > Static Route > IP Static Route**.

**Figure 113** Management > Static Route > IP Static Route > Edit

The screenshot shows the 'Static Route Setup' configuration page. The fields are as follows:

- Route Name: [Empty text box]
- Active:
- Private:
- Destination IP Address: [0.0.0.0]
- IP Subnet Mask: [0.0.0.0]
- Gateway IP Address: [0.0.0.0]
- Metric: [2]

Buttons: [Apply] [Cancel]

Each field is described in the following table.

**Table 83** Management > Static Route > IP Static Route > Edit

LABEL	DESCRIPTION
Route Name	Enter the name of the static route.
Active	Select this if you want the static route to be used. Clear this if you do not want the static route to be used.
Private	Select this if you do not want the ZyXEL Device to tell other routers about this static route. For example, you might select this if the static route is in your LAN. Clear this if you want the ZyXEL Device to tell other routers about this static route.
Destination IP Address	Enter one of the destination IP addresses that this static route affects.
IP Subnet Mask	Enter the subnet mask that defines the range of destination IP addresses that this static route affects. If this static route affects only one IP address, enter 255.255.255.255.
Gateway IP Address	Enter the IP address of the gateway to which the ZyXEL Device should send packets for the specified <b>Destination</b> . The gateway is a router or a switch on the same network segment as the device's LAN or WAN port. The gateway helps forward packets to their destinations.
Metric	Usually, you should keep the default value. This field is related to RIP. See <a href="#">Chapter 7 on page 105</a> for more information. The metric represents the "cost of transmission". A router determines the best route for transmission by choosing a path with the lowest "cost". The smaller the metric, the lower the "cost". RIP uses hop count as the measurement of cost, where 1 is for a directly-connected network. The metric must be 1-15; if you use a value higher than 15, the routers assume the link is down.
Apply	Click this to save your changes and to apply them to the ZyXEL Device.
Cancel	Click this to return to the previous screen without saving your changes.



# Bandwidth MGMT

Use these screens to manage the amount of traffic the ZyXEL Device routes through each interface.

## 17.1 Bandwidth Management Overview

Bandwidth management allows you to allocate an interface's outgoing capacity to specific types of traffic. It can also help you make sure that the ZyXEL Device forwards certain types of traffic (especially real-time applications) with minimum delay. With the use of real-time applications such as Voice-over-IP (VoIP) increasing, the requirement for bandwidth allocation is also increasing.

Bandwidth management addresses questions such as:

- Who gets how much access to specific applications?
- What priority level should you give to each type of traffic?
- Which traffic must have guaranteed delivery?
- How much bandwidth should be allotted to guarantee delivery?

Bandwidth management also allows you to configure the allowed output for an interface to match what the network can handle. This helps reduce delays and dropped packets at the next routing device. For example, you can set the WAN interface speed to 1024 kbps (or less) if the broadband device connected to the WAN port has an upstream speed of 1024 kbps.

### 17.1.1 Bandwidth Classes and Filters

Use bandwidth classes and sub-classes to allocate specific amounts of bandwidth capacity (bandwidth budgets). Configure a bandwidth filter to define a bandwidth class (or sub-class) based on a specific application and/or subnet. Use the [Bandwidth Class Setup Screen](#) to set up a bandwidth class's name, bandwidth allotment, and bandwidth filter. You can configure up to one bandwidth filter per bandwidth class. You can also configure bandwidth classes without bandwidth filters. However, it is recommended that you configure sub-classes with filters for any classes that you configure without filters. The ZyXEL Device leaves the bandwidth budget allocated and unused for a class that does not have a filter or sub-classes with filters. View your configured bandwidth classes and sub-classes in the [Bandwidth Class Setup Screen](#).

The total of the configured bandwidth budgets for sub-classes cannot exceed the configured bandwidth budget speed of the parent class.

## 17.1.2 Proportional Bandwidth Allocation

Bandwidth management allows you to define how much bandwidth each class gets; however, the actual bandwidth allotted to each class decreases or increases in proportion to actual available bandwidth.

## 17.1.3 Application-based Bandwidth Management

You can create bandwidth classes based on individual applications (like VoIP, Web, FTP, E-mail and Video for example).

## 17.1.4 Subnet-based Bandwidth Management

You can create bandwidth classes based on subnets. The following figure shows LAN subnets. You could configure one bandwidth class for subnet A and another for subnet B.

**Figure 114** Subnet-based Bandwidth Management Example

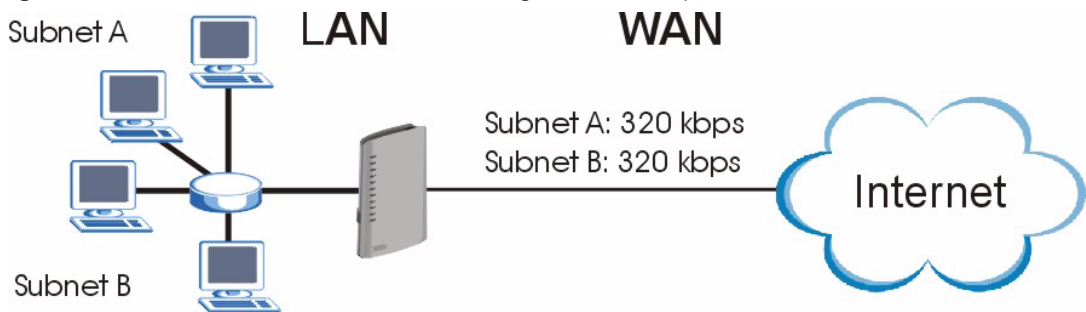

## 17.1.5 Application- and Subnet-based Bandwidth Management

You could also create bandwidth classes based on a combination of a subnet and an application. The following example table shows bandwidth allocations for application specific traffic from separate LAN subnets.

**Table 84** Application and Subnet-based Bandwidth Management Example

TRAFFIC TYPE	FROM SUBNET A	FROM SUBNET B
VoIP	64 Kbps	64 Kbps
Web	64 Kbps	64 Kbps
FTP	64 Kbps	64 Kbps
E-mail	64 Kbps	64 Kbps
Video	64 Kbps	64 Kbps

## 17.1.6 Scheduler

The scheduler divides up an interface's bandwidth among the bandwidth classes. The ZyXEL Device has two types of schedulers: fairness-based and priority-based.

With the priority-based scheduler, the ZyXEL Device forwards traffic from bandwidth classes according to the priorities that you assign to the bandwidth classes. The larger a bandwidth class's priority number is, the higher the priority. Assign real-time applications (like those using audio or video) a higher priority number to provide smoother operation.

The ZyXEL Device divides bandwidth equally among bandwidth classes when using the fairness-based scheduler; thus preventing one bandwidth class from using all of the interface's bandwidth.

## 17.1.7 Maximize Bandwidth Usage

This option allows the ZyXEL Device to divide up any available bandwidth on the interface (including unallocated bandwidth and any allocated bandwidth that a class is not using) among the bandwidth classes that require more bandwidth.

When you enable maximize bandwidth usage, the ZyXEL Device first makes sure that each bandwidth class gets up to its bandwidth allotment. Next, the ZyXEL Device divides up an interface's available bandwidth (bandwidth that is unbudgeted or unused by the classes) depending on how many bandwidth classes require more bandwidth and on their priority levels. When only one class requires more bandwidth, the ZyXEL Device gives extra bandwidth to that class.

When multiple classes require more bandwidth, the ZyXEL Device gives the highest priority classes the available bandwidth first (as much as they require, if there is enough available bandwidth), and then to lower priority classes if there is still bandwidth available. The ZyXEL Device distributes the available bandwidth equally among classes with the same priority level.

### 17.1.7.1 Reserving Bandwidth for Non-Bandwidth Class Traffic

Do the following three steps to configure the ZyXEL Device to allow bandwidth for traffic that is not defined in a bandwidth filter.

- 1 Leave some of the interface's bandwidth unbudgeted.
- 2 Do not enable the interface's **Maximize Bandwidth Usage** option.
- 3 Do not enable bandwidth borrowing on the sub-classes (see [Section 17.1.8 on page 201](#)).

### 17.1.7.2 Maximize Bandwidth Usage Example

Here is an example of a ZyXEL Device that has maximize bandwidth usage enabled on an interface. The following table shows each bandwidth class's bandwidth budget. The classes are set up based on subnets. The interface is set to 10240 kbps. Each subnet is allocated 2048 kbps. The unbudgeted 2048 kbps allows traffic not defined in any of the bandwidth filters to go out when you do not select the maximize bandwidth option.

**Table 85** Maximize Bandwidth Usage Example

BANDWIDTH CLASSES AND ALLOTMENTS	
Root Class: 10240 kbps	Administration: 2048 kbps
	Sales: 2048 kbps
	Marketing: 2048 kbps
	Research: 2048 kbps

The ZyXEL Device divides up the unbudgeted 2048 kbps among the classes that require more bandwidth. If the administration department only uses 1024 kbps of the budgeted 2048 kbps, the ZyXEL Device also divides the remaining 1024 kbps among the classes that require more bandwidth. Therefore, the ZyXEL Device divides a total of 3072 kbps of unbudgeted and unused bandwidth among the classes that require more bandwidth.

### 17.1.7.3 Priority-based Allotment of Unused & Unbudgeted Bandwidth

The following table shows the priorities of the bandwidth classes and the amount of bandwidth that each class gets.

**Table 86** Priority-based Allotment of Unused & Unbudgeted Bandwidth Example

BANDWIDTH CLASSES, PRIORITIES AND ALLOTMENTS	
Root Class: 10240 kbps	Administration: Priority 4, 1024 kbps
	Sales: Priority 6, 3584 kbps
	Marketing: Priority 6, 3584 kbps
	Research: Priority 5, 2048 kbps

Suppose that all of the classes except for the administration class need more bandwidth.

- Each class gets up to its budgeted bandwidth. The administration class only uses 1024 kbps of its budgeted 2048 kbps.
- The sales and marketing are first to get extra bandwidth because they have the highest priority (6). If they each require 1536 kbps or more of extra bandwidth, the ZyXEL Device divides the total 3072 kbps total of unbudgeted and unused bandwidth equally between the sales and marketing departments (1536 kbps extra to each for a total of 3584 kbps for each) because they both have the highest priority level.
- Research requires more bandwidth but only gets its budgeted 2048 kbps because all of the unbudgeted and unused bandwidth goes to the higher priority sales and marketing classes.

### 17.1.7.4 Fairness-based Allotment of Unused & Unbudgeted Bandwidth

The following table shows the amount of bandwidth that each class gets.

**Table 87** Fairness-based Allotment of Unused & Unbudgeted Bandwidth Example

BANDWIDTH CLASSES AND ALLOTMENTS	
Root Class: 10240 kbps	Administration: 1024 kbps
	Sales: 3072 kbps
	Marketing: 3072 kbps
	Research: 3072 kbps

Suppose that all of the classes except for the administration class need more bandwidth.

- Each class gets up to its budgeted bandwidth. The administration class only uses 1024 kbps of its budgeted 2048 kbps.
- The ZyXEL Device divides the total 3072 kbps total of unbudgeted and unused bandwidth equally among the other classes. 1024 kbps extra goes to each so the other classes each get a total of 3072 kbps



## 17.1.8 Bandwidth Borrowing

Bandwidth borrowing allows a sub-class to borrow unused bandwidth from its parent class, whereas maximize bandwidth usage allows any bandwidth class to borrow any unused or unbudgeted bandwidth on the whole interface.

Enable bandwidth borrowing on a sub-class to allow the sub-class to use the parent class's unused bandwidth. The parent class's unused bandwidth is given to the highest priority sub-class first (see [Section 17.1.8.1 on page 201](#)).

The total of the bandwidth allotments for sub-classes cannot exceed the bandwidth allotment of the parent class. The ZyXEL Device uses the scheduler to divide the parent class's unused bandwidth among the sub-classes that have bandwidth borrowing enabled.

### 17.1.8.1 Bandwidth Borrowing Example

Here is an example of bandwidth management with classes configured for bandwidth borrowing. The classes are set up based on departments and individuals within certain departments.

**Table 88** Bandwidth Borrowing Example

BANDWIDTH CLASSES AND BANDWIDTH BORROWING SETTINGS	
Root Class:	Administration: Borrowing Enabled
	Sales: Borrowing Disabled
	Marketing: Borrowing Enabled
	Research: Borrowing Enabled

- The Sales class cannot borrow unused bandwidth from the Root class because the Sales class has bandwidth borrowing disabled.

### 17.1.8.2 Maximize Bandwidth Usage With Bandwidth Borrowing

If you configure both maximize bandwidth usage (on the interface) and bandwidth borrowing (on individual sub-classes), the ZyXEL Device functions as follows.

- 1 The ZyXEL Device sends traffic according to each bandwidth class's bandwidth budget.
- 2 The ZyXEL Device assigns a parent class's unused bandwidth to its sub-classes that have more traffic than their budgets and have bandwidth borrowing enabled. The ZyXEL Device gives priority to sub-classes of higher priority and treats classes of the same priority equally.
- 3 The ZyXEL Device assigns any remaining unused or unbudgeted bandwidth on the interface to any class that requires it. The ZyXEL Device gives priority to classes of higher priority and treats classes of the same level equally.
- 4 If the bandwidth requirements of all of the traffic classes are met and there is still some unbudgeted bandwidth, the ZyXEL Device assigns it to traffic that does not match any of the classes.

## 17.1.9 Over Allotment of Bandwidth

You can set the bandwidth management speed for an interface higher than the interface's actual transmission speed. Higher priority traffic gets to use up to its allocated bandwidth, even if it takes up all of the interface's available bandwidth. This could stop lower priority traffic from being sent. The following is an example.

**Table 89** Over Allotment of Bandwidth Example

BANDWIDTH CLASSES, ALLOTMENTS		PRIORITIES
Actual outgoing bandwidth available on the interface: 1000 kbps		
Root Class: 1500 kbps (same as Speed setting)	VoIP traffic (Service = SIP): 500 Kbps	High
	NetMeeting traffic (Service = H.323): 500 kbps	High
	FTP (Service = FTP): 500 Kbps	Medium

If you use VoIP and NetMeeting at the same time, the device allocates up to 500 Kbps of bandwidth to each of them before it allocates any bandwidth to FTP. As a result, FTP can only use bandwidth when VoIP and NetMeeting do not use all of their allocated bandwidth.

Suppose you try to browse the web too. In this case, VoIP, NetMeeting and FTP all have higher priority, so they get to use the bandwidth first. You can only browse the web when VoIP, NetMeeting, and FTP do not use all 1000 Kbps of available bandwidth.

## 17.2 Bandwidth Management Screens

### 17.2.1 Bandwidth Management Summary Screen

Use this screen to enable bandwidth management on an interface and to set the maximum allowed bandwidth and the scheduler for the interface. You can also enable or disable maximize bandwidth usage. To access this screen, click **Management > Bandwidth MGMT > Summary**.

**Figure 115** Management > Bandwidth MGMT > Summary

Each field is described in the following table.

**Table 90** Management > Bandwidth MGMT > Summary

LABEL	DESCRIPTION
LAN	
Active	Select this to enable bandwidth management on the LAN. Bandwidth management applies to all traffic flowing out of the router through the LAN, regardless of the traffic's source. Traffic redirect or IP alias may cause LAN-to-LAN traffic to pass through the ZyXEL Device and be managed by bandwidth management.
Speed	Enter the amount of bandwidth for this interface that you want to allocate using bandwidth management. The recommendation is to set this speed to match the interface's actual transmission speed. For example, set the LAN interface speed to 10000 kbps if your Internet connection has an upstream transmission speed of 10 Mbps. You can set this number higher than the interface's actual transmission speed. This will stop lower priority traffic from being sent if higher priority traffic uses all of the actual bandwidth. You can also set this number lower than the interface's actual transmission speed. If you do not enable <b>Max Bandwidth Usage</b> , this will cause the ZyXEL Device to not use some of the interface's available bandwidth. This field is not affected by the <a href="#">Bandwidth Management Wizard</a> .
Scheduler	Select <b>Priority-Based</b> to give preference to bandwidth classes with higher priorities. Select <b>Fairness-Based</b> to treat all bandwidth classes equally.
Maximize Bandwidth Usage	Select this if you want the ZyXEL Device to divide any unallocated and unused bandwidth among bandwidth classes that require bandwidth. Clear this if you want to reserve bandwidth for traffic that does not match a bandwidth class or if you want to limit the speed of this interface.
WAN	

**Table 90** Management > Bandwidth MGMT > Summary

LABEL	DESCRIPTION
Active	Select this to enable bandwidth management on the WAN. Bandwidth management applies to all traffic flowing out of the router through the WAN, regardless of the traffic's source.
Speed	<p>Enter the amount of bandwidth for this interface that you want to allocate using bandwidth management.</p> <p>The recommendation is to set this speed to match the interface's actual transmission speed. For example, set the WAN interface speed to 1000 kbps if your Internet connection has an upstream transmission speed of 1 Mbps.</p> <p>You can set this number higher than the interface's actual transmission speed. This will stop lower priority traffic from being sent if higher priority traffic uses all of the actual bandwidth.</p> <p>You can also set this number lower than the interface's actual transmission speed. If you do not enable <b>Max Bandwidth Usage</b>, this will cause the ZyXEL Device to not use some of the interface's available bandwidth.</p> <p>This field is not affected by the <a href="#">Bandwidth Management Wizard</a>.</p>
Scheduler	Select <b>Priority-Based</b> to give preference to bandwidth classes with higher priorities. Select <b>Fairness-Based</b> to treat all bandwidth classes equally.
Maximize Bandwidth Usage	Select this if you want the ZyXEL Device to divide any unallocated and unused bandwidth among bandwidth classes that require bandwidth. Clear this if you want to reserve bandwidth for traffic that does not match a bandwidth class or if you want to limit the speed of this interface.
WLAN	
Active	Select this to enable bandwidth management on the WLAN. Bandwidth management applies to all traffic flowing out of the router through the WLAN, regardless of the traffic's source.
Speed	<p>Enter the amount of bandwidth for this interface that you want to allocate using bandwidth management.</p> <p>The recommendation is to set this speed to match the interface's actual transmission speed. For example, set the WLAN interface speed to 1000 kbps if your Internet connection has an upstream transmission speed of 1 Mbps.</p> <p>You can set this number higher than the interface's actual transmission speed. This will stop lower priority traffic from being sent if higher priority traffic uses all of the actual bandwidth.</p> <p>You can also set this number lower than the interface's actual transmission speed. If you do not enable <b>Max Bandwidth Usage</b>, this will cause the ZyXEL Device to not use some of the interface's available bandwidth.</p> <p>This field is not affected by the <a href="#">Bandwidth Management Wizard</a>.</p>
Scheduler	Select <b>Priority-Based</b> to give preference to bandwidth classes with higher priorities. Select <b>Fairness-Based</b> to treat all bandwidth classes equally.
Maximize Bandwidth Usage	Select this if you want the ZyXEL Device to divide any unallocated and unused bandwidth among bandwidth classes that require bandwidth. Clear this if you want to reserve bandwidth for traffic that does not match a bandwidth class or if you want to limit the speed of this interface.
Apply	Click this to save your changes and to apply them to the ZyXEL Device.
Reset	Click this to set every field in this screen to its last-saved value.

## 17.2.2 Bandwidth Class Setup Screen

Use this screen to look at the configured bandwidth classes by individual interface. Each interface has a permanent root class. The bandwidth budget of the root class is equal to the speed you configured on the interface (see [Section 17.2.1 on page 202](#)). There is a default class for all the bandwidth in the Root Class that is not allocated to bandwidth classes.



**For each interface, you must enable bandwidth management before you can configure classes.**

To access this screen, click **Management > Bandwidth MGMT > Class Setup**.

**Figure 116** Management > Bandwidth MGMT > Class Setup

Each field is described in the following table.

**Table 91** Management > Bandwidth MGMT > Class Setup

LABEL	DESCRIPTION
Class Setup	
Interface	Select the interface for which you wish to set up classes. Bandwidth management controls outgoing traffic on an interface, not incoming. In order to limit the download bandwidth of the LAN users, set the bandwidth management class on the LAN. In order to limit the upload bandwidth, set the bandwidth management class on the corresponding WAN interface.
Root Class	In this section, you can look at each class and its allocated bandwidth. Select the class to which you want to add a sub-class, which you want to edit, or which you want to delete. If you used the <b>Bandwidth Management Wizard</b> , each service you selected (except WWW) becomes a LAN sub-class and a WAN sub-class in this screen. <b>WWW</b> only becomes a LAN sub-class.
Add Sub-Class	Click this to add a sub-class to the selected class.
Edit	Click this to configure the selected class. You cannot edit the root class. The <b>Bandwidth Class Edit</b> screen appears.
Delete	Click this to delete the selected class and all its sub-classes. You cannot delete the root class.

## 17.2.3 Bandwidth Class Edit Screen

Use this screen to configure a bandwidth management class.



**For each interface, you must enable bandwidth management before you can configure classes.**

To access this screen, click **Add Sub-Class** in **Management > Bandwidth MGMT > Class Setup**.

**Figure 117** Management > Bandwidth MGMT > Class Setup > Edit

See [Appendix G on page 339](#) for examples of services for which you might create bandwidth classes. Each field is described in the following table.

**Table 92** Management > Bandwidth MGMT > Class Setup > Edit

LABEL	DESCRIPTION
	This section lets you set the budget and priority for this class.
Class Name	Finish the auto-generated name, or enter a descriptive name up to 20 alphanumeric characters long. Spaces are allowed.
Bandwidth Budget	Enter the maximum bandwidth for the class, in kbps. The recommendation is 20 - 20000 kbps for each class.
Priority	Enter the priority of this class. The higher the number, the higher the priority. Legal values are 0 - 7. The default setting is 3.

**Table 92** Management > Bandwidth MGMT > Class Setup > Edit

LABEL	DESCRIPTION
Borrow bandwidth from parent class	<p>Select this option to allow a sub-class to borrow bandwidth from its parent class if the parent class is not using up its bandwidth budget.</p> <p>Bandwidth borrowing is governed by the priority of the sub-classes. That is, a sub-class with the highest priority (7) is the first to borrow bandwidth from its parent class.</p> <p>Do not select this for the classes directly below the root class if you want to leave bandwidth available for other traffic types (see <a href="#">Section 17.1.7.1 on page 199</a>) or you want to set the interface's speed to match what the next device in network can handle (see the <b>Speed</b> field description in the <a href="#">Bandwidth Management Summary Screen</a>).</p>
	<p>This section lets you set criteria that are used to identify which traffic is managed in this class and which traffic is not managed in this class. If you leave the default value in a field, there is no restriction for that criteria.</p>
Enable Bandwidth Filter	<p>Select this if you want the ZyXEL Device to use at least one of the following filter criteria when it manages bandwidth. You must enter a value in at least one of the following fields. (The <b>Subnet Mask</b> fields are only available when you enter the destination or source IP address.)</p>
Application	<p>Select a pre-defined application. If you select a predefined application, do not set up the other filter criteria.</p> <p><b>FTP</b> (File Transfer Program) enables fast transfer of files, including large files that may not be possible by e-mail. Select this to configure the bandwidth filter for FTP traffic.</p> <p><b>SIP</b> (Session Initiation Protocol) is a signaling protocol used in Internet telephony, instant messaging, events notification and conferencing. The ZyXEL Device supports SIP traffic pass-through. Select this to configure this bandwidth filter for SIP traffic. This makes it easier to manage bandwidth for SIP traffic and is useful, for example, when there is a VoIP (Voice over Internet Protocol) device on your LAN.</p>
Destination IP Address	<p>Enter the destination IP address.</p>
Destination Subnet Mask	<p>This field is effective if you specify a <b>Destination IP Address</b>. Enter the destination subnet mask.</p>
Destination Port	<p>Enter the destination port number.</p>
Source IP Address	<p>Enter the source IP address.</p>
Source Subnet Mask	<p>This field is effective if you specify a <b>Source IP Address</b>. Enter the source subnet mask.</p>
Source Port	<p>Enter the source port number.</p>
Protocol ID	<p>Enter the IP protocol number (service type); for example, 1 for ICMP, 6 for TCP or 17 for UDP.</p>
Apply	<p>Click this to save your changes and to apply them to the ZyXEL Device.</p>
Cancel	<p>Click this to set every field in this screen to its last-saved value.</p>

## 17.2.4 Bandwidth Monitor Screen

Use this screen to look at the device's bandwidth usage and allocation. To access this screen, click **Management > Bandwidth MGMT > Monitor**.

**Figure 118** Management > Bandwidth MGMT > Monitor

Class Name	Budget (kbps)	Current Usage (kbps)
Root Class	100000	190
LAN-1	100	0
Default Class	99900	190

Each field is described in the following table.

**Table 93** Management > Bandwidth MGMT > Monitor

LABEL	DESCRIPTION
Interface	Select the interface at which you want to look in this screen.
Class Name	This field displays the name of each bandwidth class in the selected interface. The <b>Default Class</b> represents all the bandwidth in the <b>Root Class</b> that is not allocated to bandwidth classes. If you do not select <b>Maximize bandwidth usage</b> in the <a href="#">Bandwidth Management Summary Screen</a> , the ZyXEL Device uses the bandwidth in this default class to only send traffic that does not match any of the bandwidth classes. If you allocate all the root class's bandwidth to bandwidth classes, the <b>Default Class</b> still displays a budget of 2 kbps, the minimum amount of bandwidth that can be assigned to a bandwidth class.
Budget (kbps)	This field displays the amount of bandwidth allocated to each bandwidth class.
Current Usage (kbps)	This field displays the amount of bandwidth that each bandwidth class is using.
Refresh	Click <b>Refresh</b> to update the screen.



# Remote MGMT

Use these screens to control which computers can use which services to access the ZyXEL Device on each interface.

## 18.1 Remote Management Overview

Remote management allows you to determine which services/protocols can access which ZyXEL Device interface (if any) from which computers.

You may manage your ZyXEL Device from a remote location via:

**Table 94**

- Internet (WAN only)
- ALL (LAN and WAN)
- LAN only
- Neither (Disable).

To disable remote management of a service, select **Disable** in the corresponding **Server Access** field.

You may only have one remote management session running at a time. The ZyXEL Device automatically disconnects a remote management session of lower priority when another remote management session of higher priority starts. The priorities for the different types of remote management sessions are as follows.

- 1 Telnet
- 2 HTTP

### 18.1.1 Remote Management Limitations

Remote management over LAN or WAN will not work when:

- 1 You have disabled that service in one of the remote management screens.
- 2 The IP address in the **Secured Client IP** field does not match the client IP address. If it does not match, the ZyXEL Device will disconnect the session immediately.
- 3 There is already another remote management session with an equal or higher priority running. You may only have one remote management session running at one time.
- 4 There is a firewall rule that blocks it.

### 18.1.2 Remote Management and NAT

When NAT is enabled:

- Use the ZyXEL Device's WAN IP address when configuring from the WAN.

- Use the ZyXEL Device's LAN IP address when configuring from the LAN.

### 18.1.3 System Timeout

There is a default system management idle timeout of five minutes (three hundred seconds). The ZyXEL Device automatically logs you out if the management session remains idle for longer than this timeout period. The management session does not time out when a statistics screen is polling. You can change the timeout period in the **SYSTEM General** screen.

## 18.2 Remote Management Screens

### 18.2.1 WWW Screen

Use this screen to control HTTP access to your ZyXEL Device. To access this screen, click **Management > Remote MGMT > WWW**.

**Figure 119** Management > Remote MGMT > WWW

Each field is described in the following table.

**Table 95** Management > Remote MGMT > WWW

LABEL	DESCRIPTION
Server Port	Enter the port number this service can use to access the ZyXEL Device. The computer must use the same port number.
Server Access	Select the interface(s) through which a computer may access the ZyXEL Device using this service.
Secured Client IP Address	Select <b>All</b> to allow any computer to access the ZyXEL Device using this service. Select <b>Selected</b> to only allow the computer with the IP address that you specify to access the ZyXEL Device using this service.
Apply	Click this to save your changes and to apply them to the ZyXEL Device.
Cancel	Click this to set every field in this screen to its last-saved value.

### 18.2.2 Telnet Screen

Use this screen to control Telnet access to your ZyXEL Device. To access this screen, click **Management > Remote MGMT > Telnet**.

**Figure 120** Management > Remote MGMT > Telnet

The screenshot shows the 'Telnet' configuration page. At the top, there are tabs for 'WWW', 'Telnet', 'FTP', 'SNMP', 'DNS', and 'Security'. The 'Telnet' tab is active. Below the title bar, there are three configuration fields: 'Server Port' with a text box containing '23', 'Server Access' with a dropdown menu showing 'LAN & WAN', and 'Secured Client IP Address' with radio buttons for 'All' (selected) and 'Selected', followed by a text box containing '0.0.0.0'. At the bottom, there are 'Apply' and 'Cancel' buttons.

Each field is described in the following table.

**Table 96** Management > Remote MGMT > Telnet

LABEL	DESCRIPTION
Server Port	Enter the port number this service can use to access the ZyXEL Device. The computer must use the same port number.
Server Access	Select the interface(s) through which a computer may access the ZyXEL Device using this service.
Secured Client IP Address	Select <b>All</b> to allow any computer to access the ZyXEL Device using this service. Select <b>Selected</b> to only allow the computer with the IP address that you specify to access the ZyXEL Device using this service.
Apply	Click this to save your changes and to apply them to the ZyXEL Device.
Cancel	Click this to set every field in this screen to its last-saved value.

### 18.2.3 FTP Screen

Use this screen to control FTP access to your ZyXEL Device. To access this screen, click **Management > Remote MGMT > FTP**.

**Figure 121** Management > Remote MGMT > FTP

The screenshot shows the 'FTP' configuration page. At the top, there are tabs for 'WWW', 'Telnet', 'FTP', 'SNMP', 'DNS', and 'Security'. The 'FTP' tab is active. Below the title bar, there are three configuration fields: 'Server Port' with a text box containing '21', 'Server Access' with a dropdown menu showing 'LAN & WAN', and 'Secured Client IP Address' with radio buttons for 'All' (selected) and 'Selected', followed by a text box containing '0.0.0.0'. At the bottom, there are 'Apply' and 'Cancel' buttons.

Each field is described in the following table.

**Table 97** Management > Remote MGMT > FTP

LABEL	DESCRIPTION
Server Port	Enter the port number this service can use to access the ZyXEL Device. The computer must use the same port number.
Server Access	Select the interface(s) through which a computer may access the ZyXEL Device using this service.

**Table 97** Management > Remote MGMT > FTP

LABEL	DESCRIPTION
Secured Client IP Address	Select <b>All</b> to allow any computer to access the ZyXEL Device using this service. Select <b>Selected</b> to only allow the computer with the IP address that you specify to access the ZyXEL Device using this service.
Apply	Click this to save your changes and to apply them to the ZyXEL Device.
Cancel	Click this to set every field in this screen to its last-saved value.

## 18.3 SNMP

Simple Network Management Protocol (SNMP) is a protocol used for exchanging management information between network devices. SNMP is a member of the TCP/IP protocol suite. Your ZyXEL Device supports SNMP agent functionality, which allows a manager station to manage and monitor the ZyXEL Device through the network. The ZyXEL Device supports SNMP version one (SNMPv1) and version two (SNMPv2). The next figure illustrates an SNMP management operation.

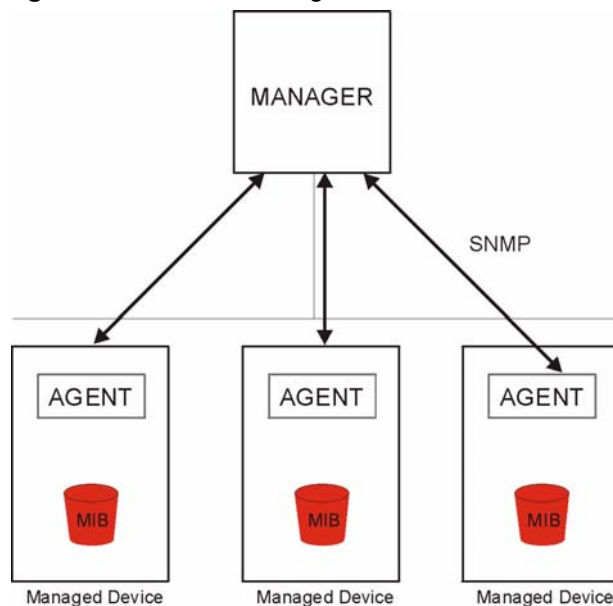

**SNMP is only available if TCP/IP is configured.**

**Figure 122** SNMP Management Model

An SNMP managed network consists of two main types of component: agents and a manager.

An agent is a management software module that resides in a managed device (the ZyXEL Device). An agent translates the local management information from the managed device into a form compatible with SNMP. The manager is the console through which network administrators perform network management functions. It executes applications that control and monitor managed devices.

The managed devices contain object variables/managed objects that define each piece of information to be collected about a device. Examples of variables include such as number of packets received, node port status etc. A Management Information Base (MIB) is a collection of managed objects. SNMP allows a manager and agents to communicate for the purpose of accessing these objects.

SNMP itself is a simple request/response protocol based on the manager/agent model. The manager issues a request and the agent returns responses using the following protocol operations:

- Get - Allows the manager to retrieve an object variable from the agent.
- GetNext - Allows the manager to retrieve the next object variable from a table or list within an agent. In SNMPv1, when a manager wants to retrieve all elements of a table from an agent, it initiates a Get operation, followed by a series of GetNext operations.
- Set - Allows the manager to set values for object variables within an agent.
- Trap - Used by the agent to inform the manager of some events.

### 18.3.1 Supported MIBs

The ZyXEL Device supports MIB II that is defined in RFC-1213 and RFC-1215. The focus of the MIBs is to let administrators collect statistical data and monitor status and performance.

### 18.3.2 SNMP Traps

The ZyXEL Device will send traps to the SNMP manager when any one of the following events occurs:

**Table 98** SNMP Traps

TRAP #	TRAP NAME	DESCRIPTION
0	coldStart (defined in <i>RFC-1215</i> )	A trap is sent after booting (power on).
1	warmStart (defined in <i>RFC-1215</i> )	A trap is sent after booting (software reboot).
4	authenticationFailure (defined in <i>RFC-1215</i> )	A trap is sent to the manager when receiving any SNMP get or set requirements with the wrong community (password).
6	whyReboot (defined in ZYXEL-MIB)	A trap is sent with the reason of restart before rebooting when the system is going to restart (warm start).
6a	For intentional reboot:	A trap is sent with the message "System reboot by user!" if reboot is done intentionally, (for example, download new files, CLI command "sys reboot", etc.).
6b	For fatal error:	A trap is sent with the message of the fatal code if the system reboots because of fatal errors.

### 18.3.3 Configuring SNMP

To change your ZyXEL Device's SNMP settings, click **Advanced > Remote MGMT > SNMP**. The screen appears as shown.

Use this screen to control FTP access to your ZyXEL Device. To access this screen, click **Management > Remote MGMT > SNMP**.

**Figure 123** Management > Remote MGMT > SNMP

The screenshot shows the SNMP Configuration screen. At the top, there are navigation tabs: WWW, Telnet, FTP, **SNMP**, DNS, and Security. Below the tabs, the screen is divided into two main sections: "SNMP Configuration" and "SNMP".

**SNMP Configuration** section:

- Get Community: public
- Set Community: public
- Trap Community: public
- Trap Destination: 0.0.0.0

**SNMP** section:

- Service Port: 161
- Service Access: LAN & WAN (dropdown menu)
- Secured Client IP Address:  All  Selected 0.0.0.0

At the bottom of the screen, there are two buttons: "Apply" and "Cancel".

The following table describes the labels in this screen.

**Table 99** Remote Management: SNMP

LABEL	DESCRIPTION
SNMP Configuration	
Get Community	Enter the <b>Get Community</b> , which is the password for the incoming Get and GetNext requests from the management station. The default is public and allows all requests.
Set Community	Enter the <b>Set community</b> , which is the password for incoming Set requests from the management station. The default is public and allows all requests.
Trap Community	Type the trap community, which is the password sent with each trap to the SNMP manager. The default is public and allows all requests.
Trap Destination	Type the IP address of the station to send your SNMP traps to.
SNMP	
Service Port	You may change the server port number for a service if needed, however you must use the same port number in order to use that service for remote management.
Service Access	Select the interface(s) through which a computer may access the ZyXEL Device using this service.
Secured Client IP Address	A secured client is a "trusted" computer that is allowed to communicate with the ZyXEL Device using this service. Select <b>All</b> to allow any computer to access the ZyXEL Device using this service. Choose <b>Selected</b> to just allow the computer with the IP address that you specify to access the ZyXEL Device using this service.
Apply	Click <b>Apply</b> to save your customized settings and exit this screen.
Cancel	Click <b>Cancel</b> to begin configuring this screen afresh.

### 18.3.4 DNS Screen

Use this screen to control DNS access to your ZyXEL Device. To access this screen, click **Management > Remote MGMT > DNS**.

**Figure 124** Management > Remote MGMT > DNS

The screenshot shows the DNS configuration page. At the top, there are tabs for WWW, Telnet, FTP, SNMP, DNS (selected), and Security. Below the tabs, the page title is 'DNS'. There are three main configuration areas: 'Service Port' with a text box containing '53'; 'Service Access' with a dropdown menu showing 'LAN & WAN'; and 'Secured Client IP Address' with two radio buttons, 'All' (selected) and 'Selected', followed by a text box containing '0.0.0.0'. At the bottom, there are 'Apply' and 'Cancel' buttons.

Each field is described in the following table.

**Table 100** Management > Remote MGMT > DNS

LABEL	DESCRIPTION
Server Port	This field is read-only. This field displays the port number this service uses to access the ZyXEL Device. The computer must use the same port number.
Server Access	Select the interface(s) through which a computer may access the ZyXEL Device using this service.
Secured Client IP Address	Select <b>All</b> to allow any computer to access the ZyXEL Device using this service. Select <b>Selected</b> to only allow the computer with the IP address that you specify to access the ZyXEL Device using this service.
Apply	Click this to save your changes and to apply them to the ZyXEL Device.
Cancel	Click this to set every field in this screen to its last-saved value.

### 18.3.5 Security Screen

Use this screen to control how your ZyXEL Device responds to other types of requests. To access this screen, click **Management > Remote MGMT > Security**.

**Figure 125** Management > Remote MGMT > Security

The screenshot shows the Security configuration page. At the top, there are tabs for WWW, Telnet, FTP, SNMP, DNS, and Security (selected). Below the tabs, the page title is 'ICMP'. There are two main configuration areas: 'Respond to Ping on' with a dropdown menu showing 'LAN & WAN'; and a checkbox labeled 'Do not respond to requests for unauthorized services' which is currently unchecked. At the bottom, there are 'Apply' and 'Cancel' buttons.

Each field is described in the following table.

**Table 101** Management > Remote MGMT > Security

LABEL	DESCRIPTION
Respond to Ping on	<p>Select the interface(s) on which the ZyXEL Device should respond to incoming ping requests.</p> <p><b>Disable</b> - the ZyXEL Device does not respond to any ping requests.</p> <p><b>LAN</b> - the ZyXEL Device only responds to ping requests received from the LAN.</p> <p><b>WAN</b> - the ZyXEL Device only responds to ping requests received from the WAN.</p> <p><b>LAN &amp; WAN</b> - the ZyXEL Device responds to ping requests received from the LAN or the WAN.</p>
Do not respond to requests for unauthorized services	<p>Select this to prevent outsiders from discovering your ZyXEL Device by sending requests to unsupported port numbers. If an outside user attempts to probe an unsupported port on your ZyXEL Device, an ICMP response packet is automatically returned. This allows the outside user to know the ZyXEL Device exists. Your ZyXEL Device supports anti-probing, which prevents the ICMP response packet from being sent. This keeps outsiders from discovering your ZyXEL Device when unsupported ports are probed.</p> <p>If you clear this, your ZyXEL Device replies with an ICMP Port Unreachable packet for a port probe on unused UDP ports and with a TCP Reset packet for a port probe on unused TCP ports.</p>
Apply	Click this to save your changes and to apply them to the ZyXEL Device.
Cancel	Click this to set every field in this screen to its last-saved value.



Use this screen to set up UPnP.

## 19.1 Introducing Universal Plug and Play

Universal Plug and Play (UPnP) is a distributed, open networking standard that uses TCP/IP for simple peer-to-peer network connectivity between devices. A UPnP device can dynamically join a network, obtain an IP address, convey its capabilities and learn about other devices on the network. In turn, a device can leave a network smoothly and automatically when it is no longer in use.

### 19.1.1 How do I know if I'm using UPnP?

UPnP hardware is identified as an icon in the Network Connections folder (Windows XP). Each UPnP compatible device installed on your network will appear as a separate icon. Selecting the icon of a UPnP device will allow you to access the information and properties of that device.

### 19.1.2 NAT Traversal

UPnP NAT traversal automates the process of allowing an application to operate through NAT. UPnP network devices can automatically configure network addressing, announce their presence in the network to other UPnP devices and enable exchange of simple product and service descriptions. NAT traversal allows the following:

- Dynamic port mapping
- Learning public IP addresses
- Assigning lease times to mappings

Windows Messenger is an example of an application that supports NAT traversal and UPnP.

See [Chapter 8 on page 117](#) for further information about NAT.

### 19.1.3 Cautions with UPnP

The automated nature of NAT traversal applications in establishing their own services and opening firewall ports may present network security issues. Network information and configuration may also be obtained and modified by users in some network environments.

When a UPnP device joins a network, it announces its presence with a multicast message. For security reasons, the ZyXEL Device allows multicast messages on the LAN only.

All UPnP-enabled devices may communicate freely with each other without additional configuration. Disable UPnP if this is not your intention.

## 19.1.4 UPnP and ZyXEL

ZyXEL has achieved UPnP certification from the Universal Plug and Play Forum UPnP™ Implementors Corp. (UIC). ZyXEL's UPnP implementation supports Internet Gateway Device (IGD) 1.0 .

See the following sections for examples of installing and using UPnP.

## 19.2 UPnP Examples

### 19.2.1 Installing UPnP in Windows Example

This section shows how to install UPnP in Windows Me and Windows XP.

#### 19.2.1.1 Installing UPnP in Windows Me

Follow the steps below to install the UPnP in Windows Me.

- 1 Click **Start** and **Control Panel**. Double-click **Add/Remove Programs**.
- 2 Click on the **Windows Setup** tab and select **Communication** in the **Components** selection box. Click **Details**.

**Figure 126** Add/Remove Programs: Windows Setup: Communication

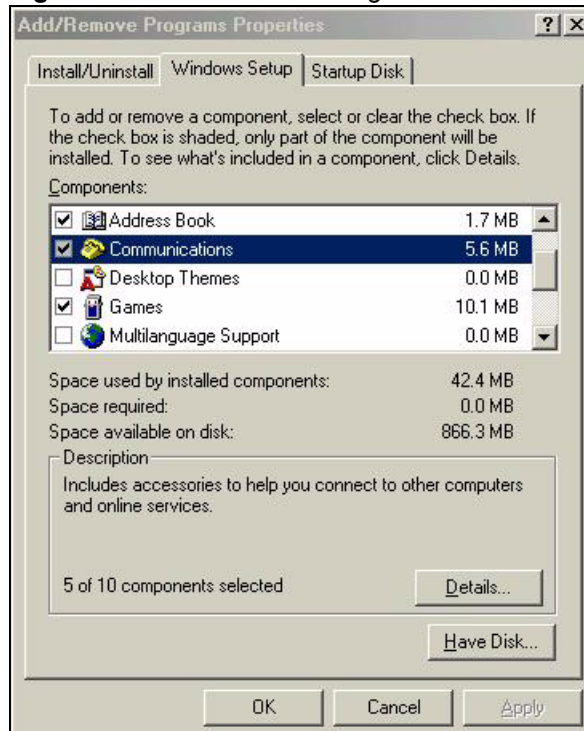

- 3 In the **Communications** window, select the **Universal Plug and Play** check box in the **Components** selection box.

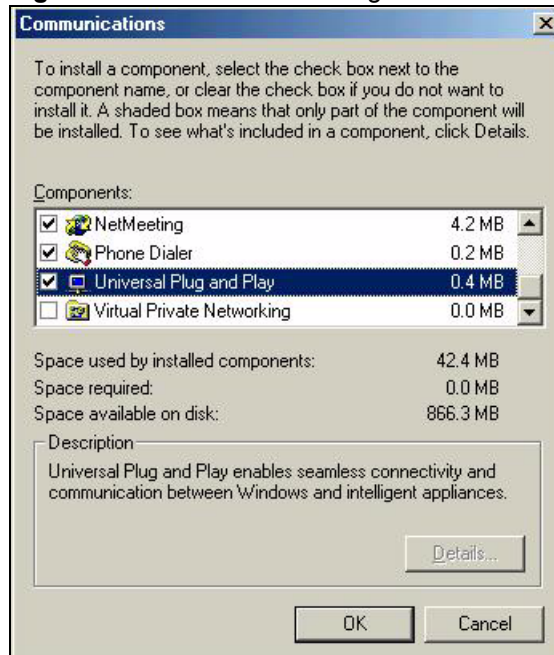
**Figure 127** Add/Remove Programs: Windows Setup: Communication: Components

- 4 Click **OK** to go back to the **Add/Remove Programs Properties** window and click **Next**.
- 5 Restart the computer when prompted.

### 19.2.1.2 Installing UPnP in Windows XP

Follow the steps below to install the UPnP in Windows XP.

- 1 Click **Start** and **Control Panel**.
- 2 Double-click **Network Connections**.
- 3 In the **Network Connections** window, click **Advanced** in the main menu and select **Optional Networking Components ...**

**Figure 128** Network Connections

- 4 The **Windows Optional Networking Components Wizard** window displays. Select **Networking Service** in the **Components** selection box and click **Details**.

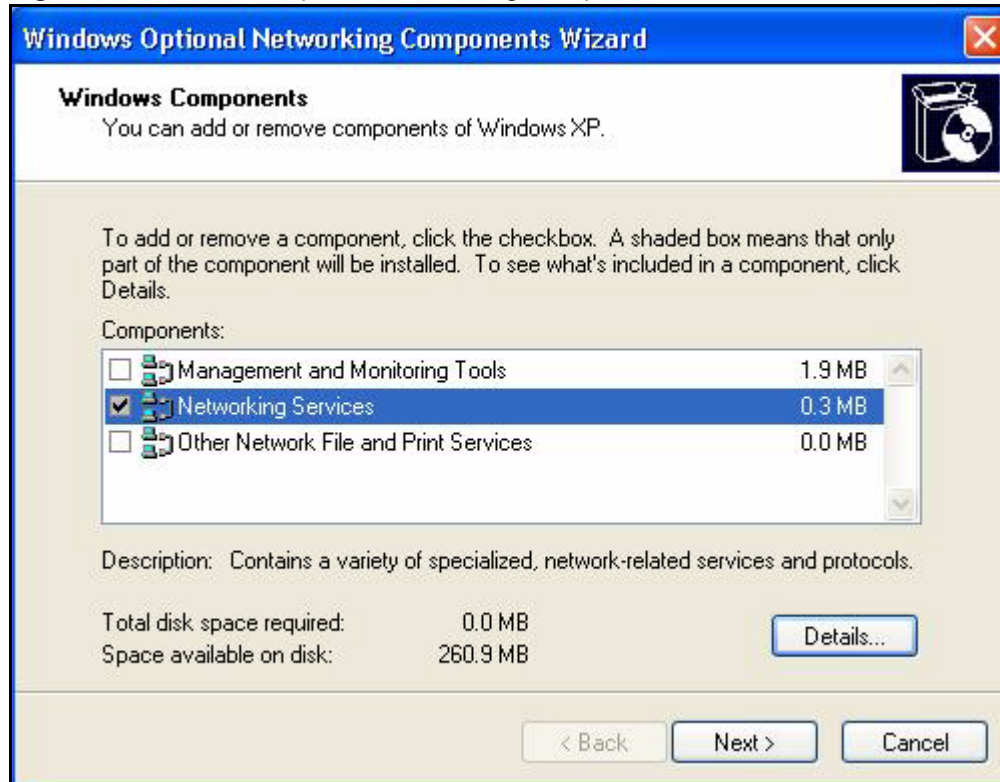
**Figure 129** Windows Optional Networking Components Wizard

**5** In the **Networking Services** window, select the **Universal Plug and Play** check box.

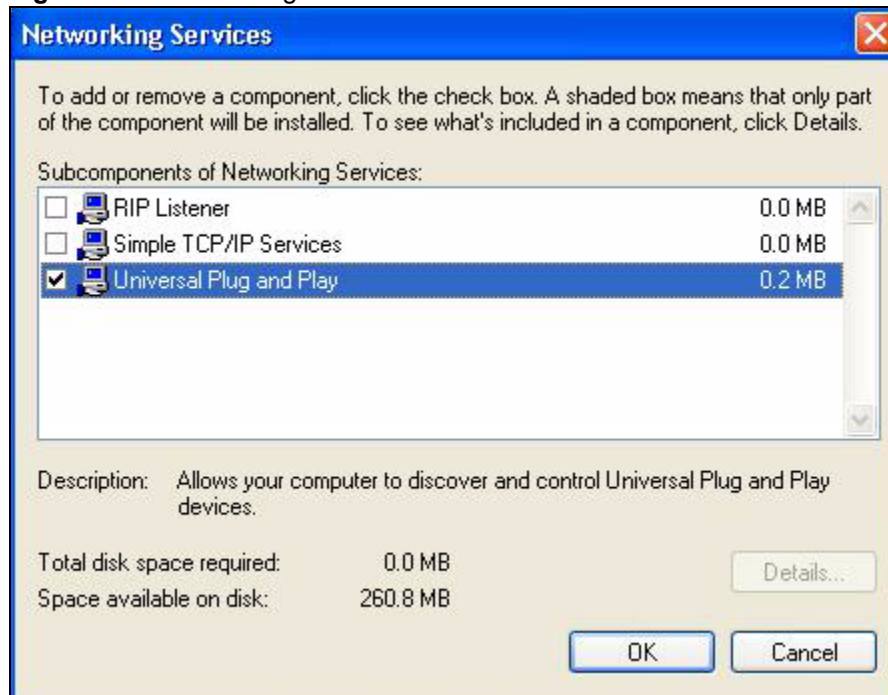
**Figure 130** Networking Services

**6** Click **OK** to go back to the **Windows Optional Networking Component Wizard** window and click **Next**.

## 19.2.2 Using UPnP in Windows XP Example

This section shows you how to use the UPnP feature in Windows XP. You must already have UPnP installed in Windows XP and UPnP activated on the ZyXEL Device.

Make sure the computer is connected to a LAN port of the ZyXEL Device. Turn on your computer and the ZyXEL Device.

### 19.2.2.1 Auto-discover Your UPnP-enabled Network Device

- 1 Click **Start** and **Control Panel**. Double-click **Network Connections**. An icon displays under Internet Gateway.
- 2 Right-click the icon and select **Properties**.

**Figure 131** Network Connections



- 3 In the **Internet Connection Properties** window, click **Settings** to see the port mappings there were automatically created.

**Figure 132** Internet Connection Properties

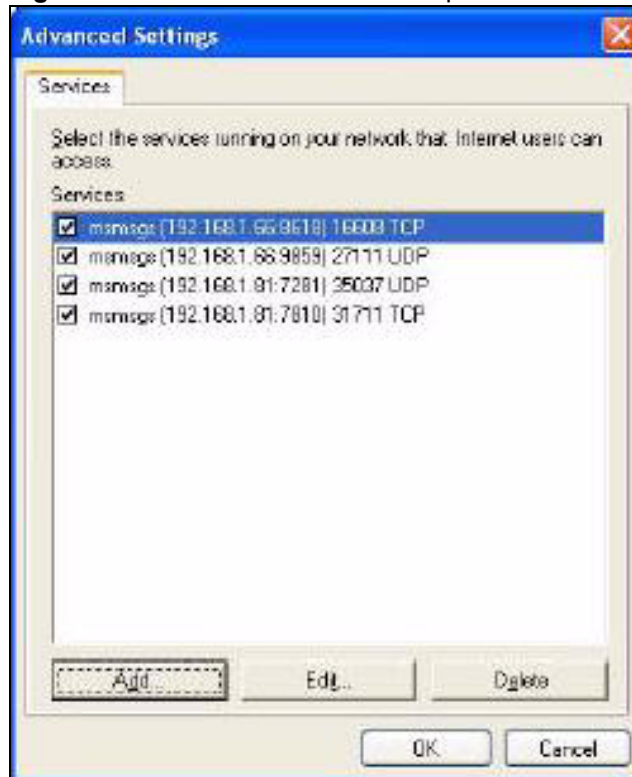
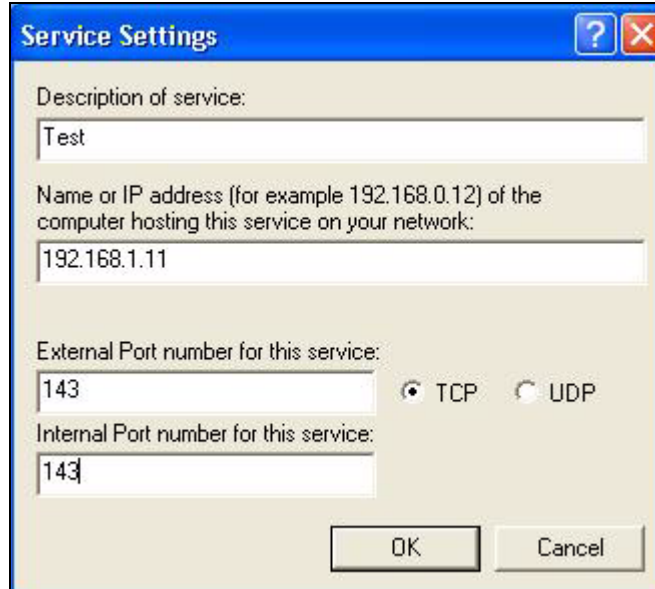

- 4 You may edit or delete the port mappings or click **Add** to manually add port mappings.

**Figure 133** Internet Connection Properties: Advanced Settings**Figure 134** Internet Connection Properties: Advanced Settings: Add

- 5 When the UPnP-enabled device is disconnected from your computer, all port mappings will be deleted automatically.
- 6 Select **Show icon in notification area when connected** option and click **OK**. An icon displays in the system tray.

**Figure 135** System Tray Icon

- 7 Double-click on the icon to display your current Internet connection status.

**Figure 136** Internet Connection Status

### 19.2.2.2 Web Configurator Easy Access

With UPnP, you can access the web-based configurator on the ZyXEL Device without finding out the IP address of the ZyXEL Device first. This comes helpful if you do not know the IP address of the ZyXEL Device.

Follow the steps below to access the web configurator.

- 1 Click **Start** and then **Control Panel**.
- 2 Double-click **Network Connections**.
- 3 Select **My Network Places** under **Other Places**.



Figure 137 Network Connections

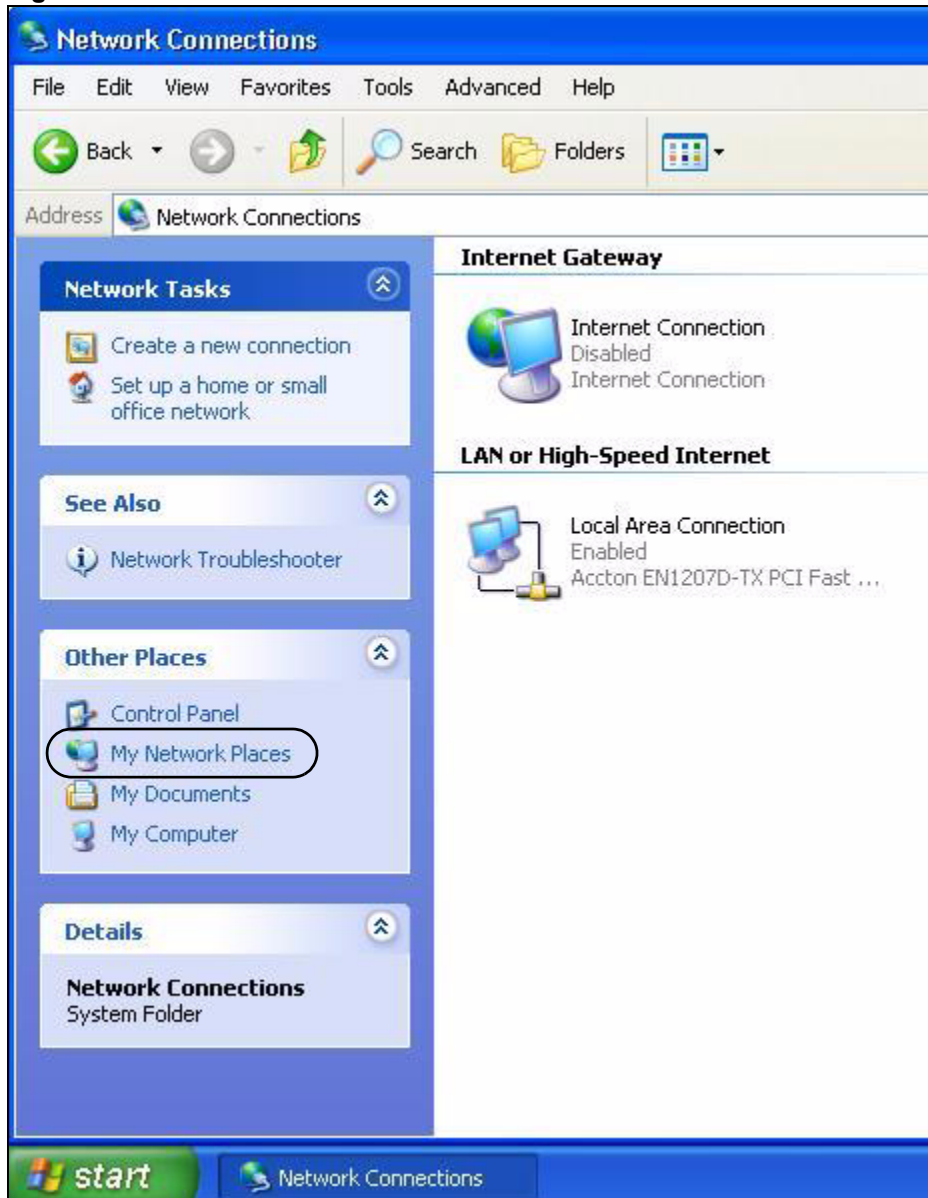

- 4 An icon with the description for each UPnP-enabled device displays under **Local Network**.
- 5 Right-click on the icon for your ZyXEL Device and select **Invoke**. The web configurator login screen displays.

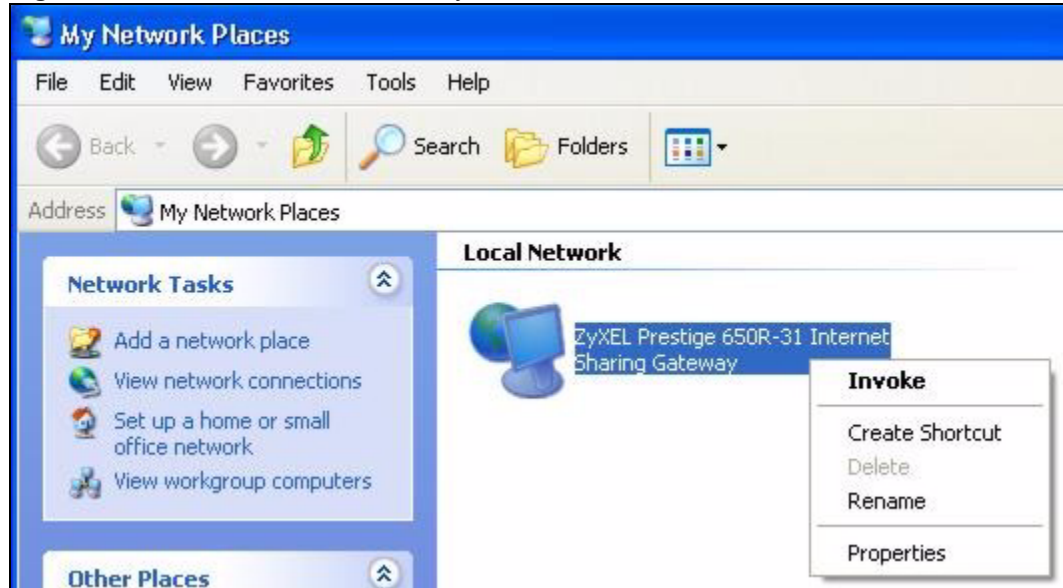
**Figure 138** Network Connections: My Network Places

- 6 Right-click on the icon for your ZyXEL Device and select **Properties**. A properties window displays with basic information about the ZyXEL Device.

**Figure 139** Network Connections: My Network Places: Properties: Example

## 19.3 UPnP Screen

Use this screen to set up UPnP in your ZyXEL Device. To access this screen, click **Management > UPnP**.

**Figure 140** Management > UPnP

Each field is described in the following table.

**Table 102** Management > UPnP

LABEL	DESCRIPTION
Device Name	This field identifies your device in UPnP applications.
Enable the Universal Plug and Play (UPnP) Feature	Select this to activate UPnP. Be aware that anyone could use a UPnP application to open the web configurator's login screen without entering the ZyXEL Device's IP address. You still have to enter the password, however.
Allow users to make configuration changes through UPnP	Select this to allow UPnP-enabled applications to automatically configure the ZyXEL Device so that they can communicate through the ZyXEL Device. For example, using NAT traversal, UPnP applications automatically reserve a NAT forwarding port in order to communicate with another UPnP enabled device; this eliminates the need to manually configure port forwarding for the UPnP enabled application.
Allow UPnP to pass through Firewall	Select this to allow traffic from UPnP-enabled applications to bypass the firewall. Clear this if you want the firewall to check UPnP application packets (for example, MSN packets).
Apply	Click this to save your changes and to apply them to the ZyXEL Device.
Cancel	Click this to set every field in this screen to its last-saved value.



# Sharing a USB Printer

This chapter describes how you can share a USB printer via your ZyXEL Device.

## 20.1 Overview

The ZyXEL Device allows you to share a USB printer on your LAN. You can do this by connecting a USB printer to one of the USB ports on the ZyXEL Device and then configuring a TCP/IP port on the computers connected to your network.

**Figure 141** Sharing a USB Printer

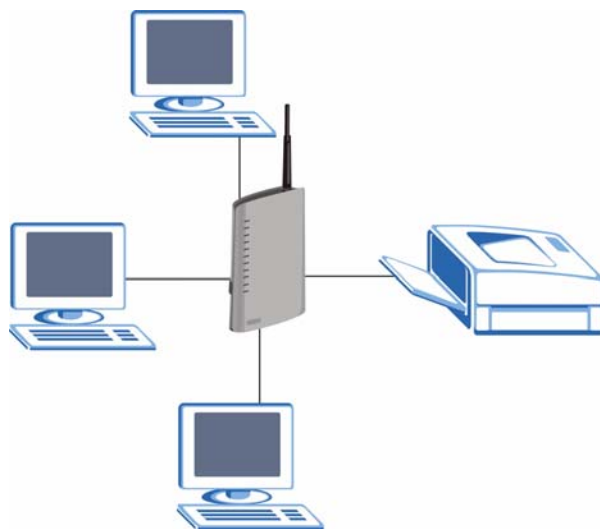

The computers on your network must have the printer software already installed before they can create a TCP/IP port for printing via the network. Follow your printer manufacturers instructions on how to install the printer software on your computer. See [Section 20.5 on page 235](#) for an example of adding a printer.

## 20.2 Requirements

To configure the print server you need the following:

- Microsoft Windows 95, Windows 98 SE (Second Edition), Windows Me, Windows NT 4.0, Windows 2000, Windows XP or Macintosh OS X.

- Your operating system must support TCP/IP ports for printing and be compatible with the Line Printer Remote (LPR) protocol.
- A USB printer with the driver already installed on your computer.

## 20.3 Configure a TCP/IP Printer Port

This example shows screens from a Windows 2000 Professional operating system. Some menu items may look different on your system. The TCP/IP port must be configured with the IP address of the ZyXEL Device and must use the LPR (Line Printer Remote) protocol to communicate with the printer. Consult your operating systems documentation for instructions on how to do this or follow the instructions below if you have a Windows 2000/XP operating system.

- 1 Click **Start**, **Settings**, then right click on **Printers** and select **Open**.

**Figure 142** Open Printers Window

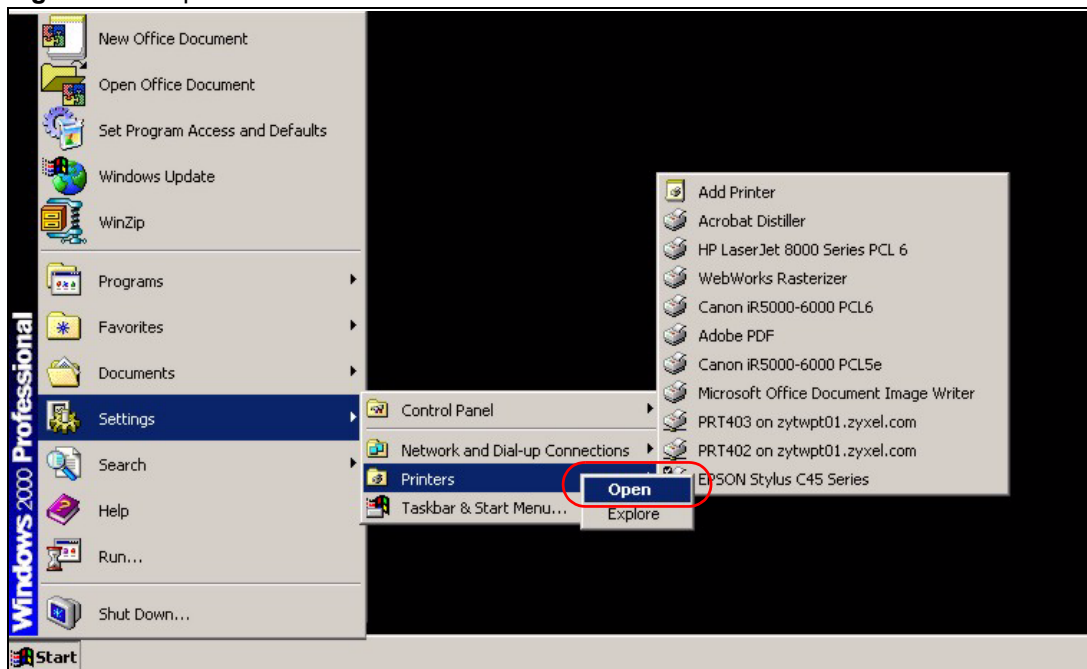

The **Printers** folder opens up. First you need to open up the properties windows for the printer you want to configure a TCP/IP port.

- 2 Locate your printer.
- 3 Right click on your printer and select properties.

Figure 143 Open Printer Properties

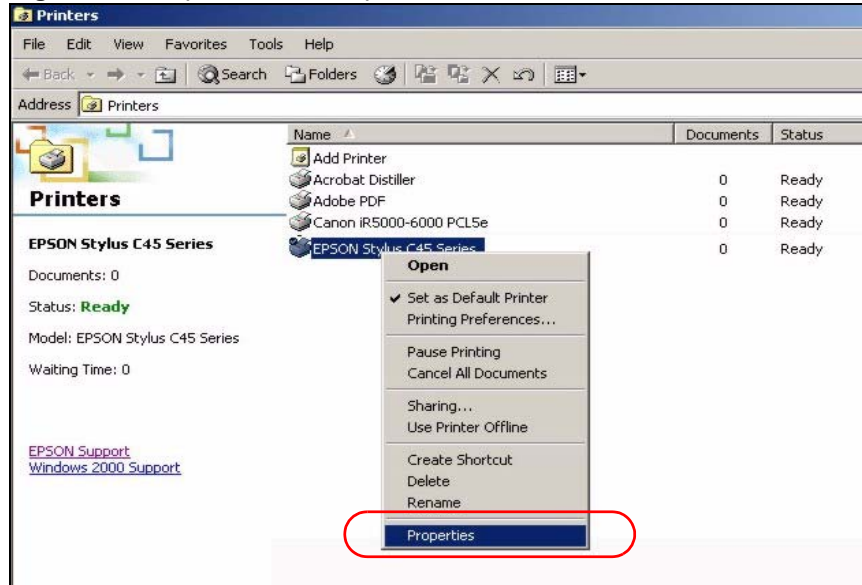

4 Select the **Ports** tab and click **Add Port...**

Figure 144 Printer Properties Window

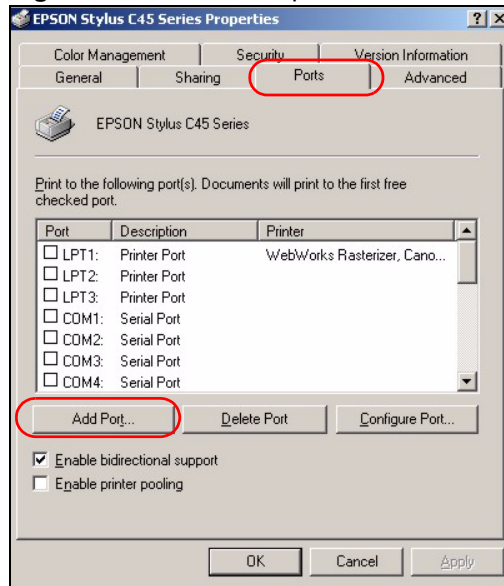

5 A **Printer Ports** window appears. Select **Standard TCP/IP Port** and click **New Port...**

Figure 145 Add a Port Window

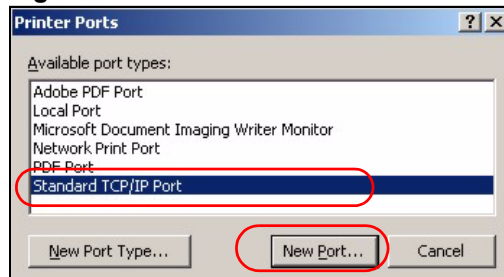

- 6 **Add Standard TCP/IP Printer Port Wizard** window opens up. Click **Next** to start configuring the printer port.

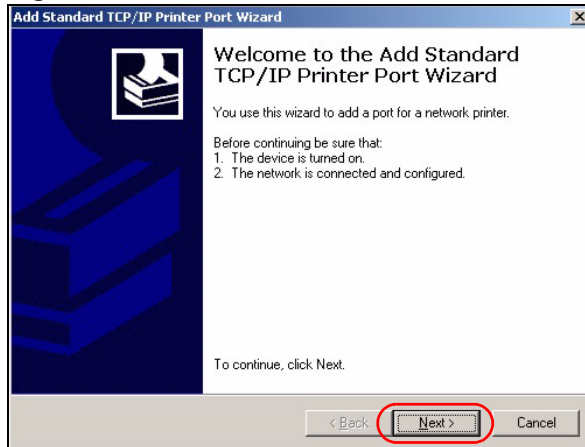
**Figure 146** Add a Port Wizard

- 7 Enter the IP address of the ZyXEL Device to which the printer is connected in the **Printer Name or IP Address:** field. In our example we use the default IP address of the ZyXEL Device, 192.168.1.1. The **Port Name** field updates automatically to reflect the IP address of the port. Click **Next**.

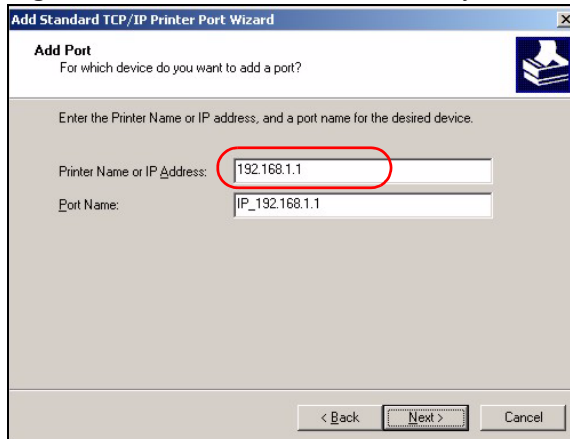

**The computer from which you are configuring the TCP/IP printer port must be on the same LAN in order to use the printer sharing function.**

**Figure 147** Enter IP Address of the ZyXEL Device

- 8 Select **Custom** under **Device Type** and click **Settings**.

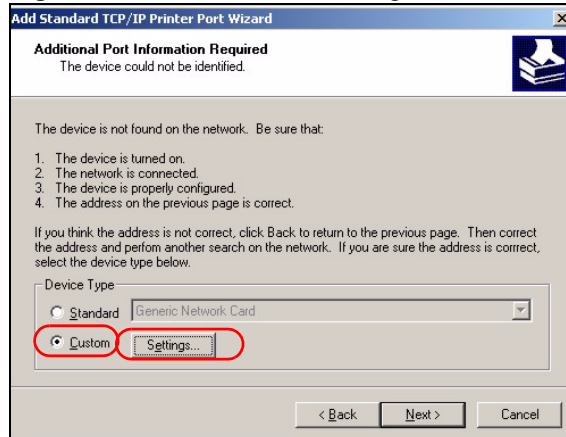
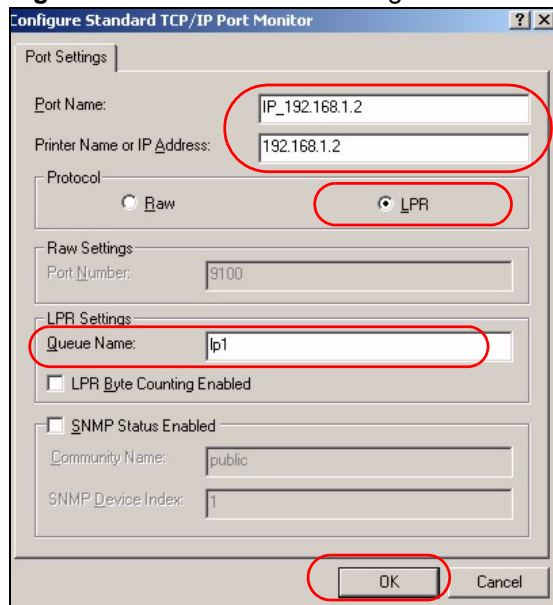

**Figure 148** Custom Port Settings

**9** Confirm the IP address of the ZyXEL Device in the IP Address field.

**10** Select **LPR** under **Protocol**.

**11** Type the LPR queue name of your printer model in the **Queue Name** field and click **OK**. Refer to your printer documentation for the LPR queue name. Some printer models accept any name you want to use, in this case you can enter a short descriptive name for the **Queue Name**.

**Figure 149** Custom Port Settings

**12** Continue through the wizard, apply your settings and close the wizard window.

**Figure 150** Finish Adding the TCP/IP Port

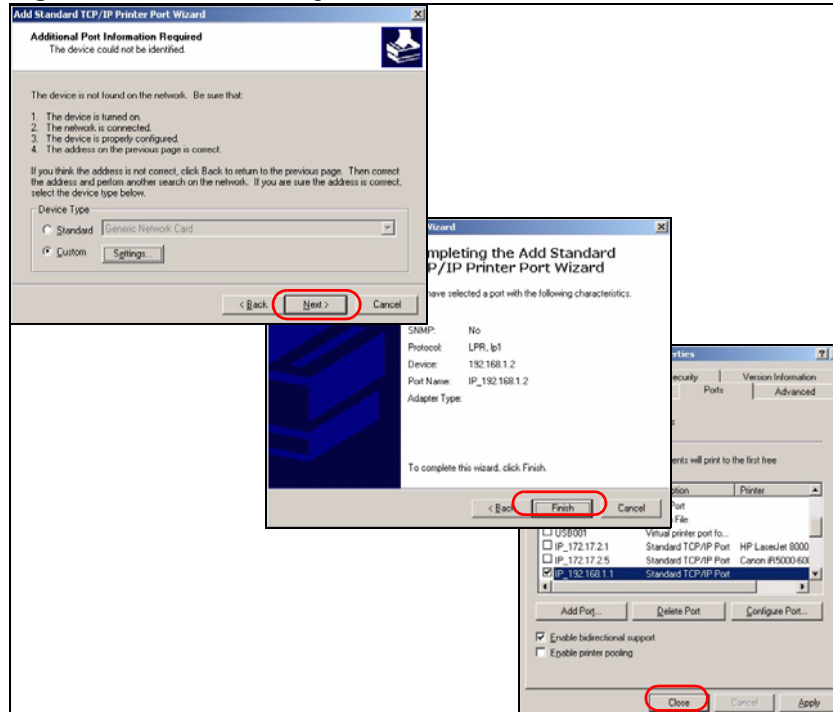

**13** Repeat steps 1 to 12 to add this printer to other computers on your network.

## 20.4 Print Server Screen

The print server screen is used to confirm that the ZyXEL Device and the USB printer are able to communicate successfully.

Click the **Print Server** link under **Management** to display the **Print Server** screen.

**Figure 151** Configuring Print Server

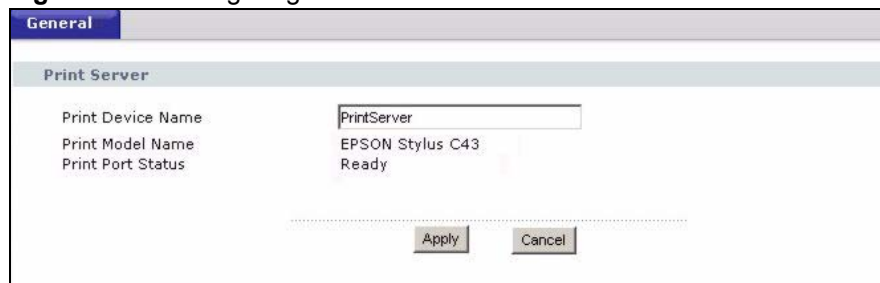

The following table describes the labels in this screen.

**Table 103** Configuring Print Server

LABEL	DESCRIPTION
Print Device Name	Type a <b>Print Device Name</b> (of up to 31 printable characters) for recognition of the associated printer on the print server network. This name is displayed on a computer on the print server network when a print job is executed.
Print Model Name	This displays the model name of the printer currently connected to the ZyXEL Device print server.

**Table 103** Configuring Print Server

LABEL	DESCRIPTION
Print Port Status	This field displays the print server status on the ZyXEL Device. <b>Ready:</b> The print server has established a TCP/IP connection with a printer, is online and ready to print. <b>Printing:</b> A computer on the print server network is executed a print job. <b>PaperOut:</b> The printer loading tray has no paper to perform the printing job <b>Offline:</b> The computers in the print server network cannot use the print server. Make sure a USB v1.1 compliant printer is connected to the ZyXEL Device's USB port and powered on.
Apply	Click <b>Apply</b> to save your changes back to the ZyXEL Device.
Cancel	Click <b>Cancel</b> to configure the <b>Print Device Name</b> afresh.

## 20.5 Adding a New Printer Example

- 1 Open your **Printers** folder and double click **Add Printer**.

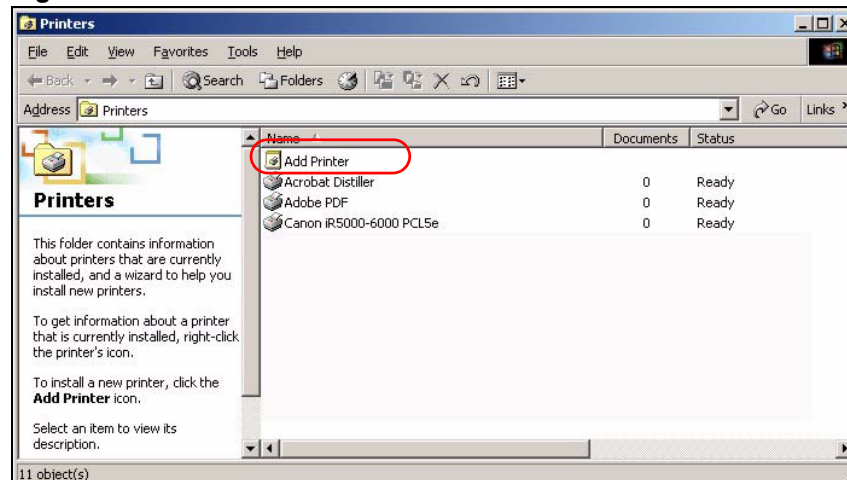
**Figure 152** Printers Folder

- 2 The **Add Printer Wizard** screen displays. Click **Next**.

**Figure 153** Add Printer Wizard: Welcome



**3** Select **Local printer** and click **Next**.

**Figure 154** Add Printer Wizard: Local or Network Printer

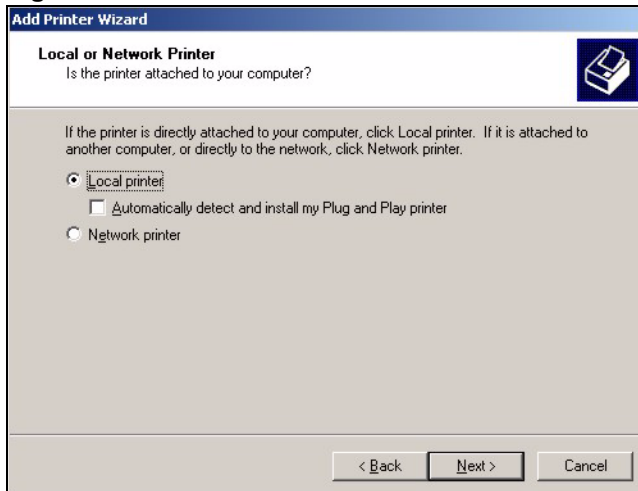

**4** Select an **LPT** (Line Printing Terminal) port (a parallel port) as the computer interface for the USB printer.

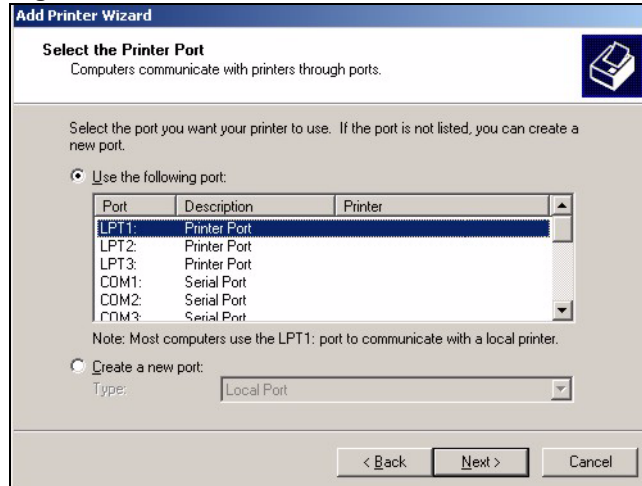
**Figure 155** Add Printer Wizard: Select the Printer Port

- 5 Select the make of the printer that you want to connect to the print server in the **Manufacturers** list of printers.
- 6 Select the printer model from the list of **Printers**.
- 7 If your printer is not displayed in the list of **Printers**, you can insert the printer driver installation CD/disk or download the driver file to your computer, click **Have Disk...** and install the new printer driver.
- 8 Click **Next** to continue.

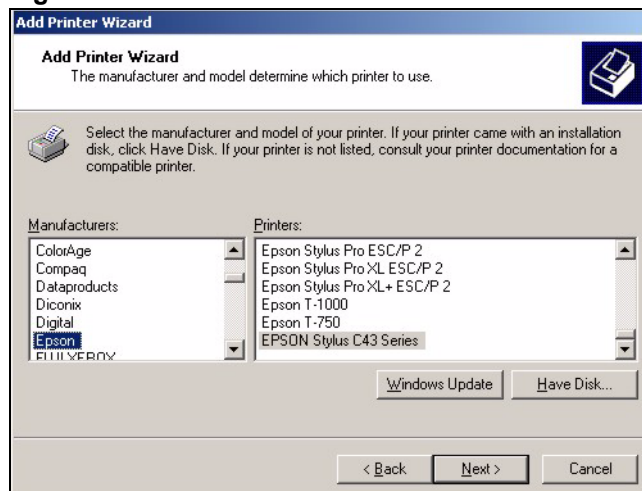
**Figure 156** Add Printer Wizard: Printer Driver

- 9 If the following screen displays, select **Keep existing driver** radio button and click **Next** if you already have a printer driver installed on your computer and you do not want to change it. Otherwise, select **Replace existing driver** to replace it with the new driver you selected in the previous screen and click **Next**.

**Figure 157** Add Printer Wizard: Use Existing Driver

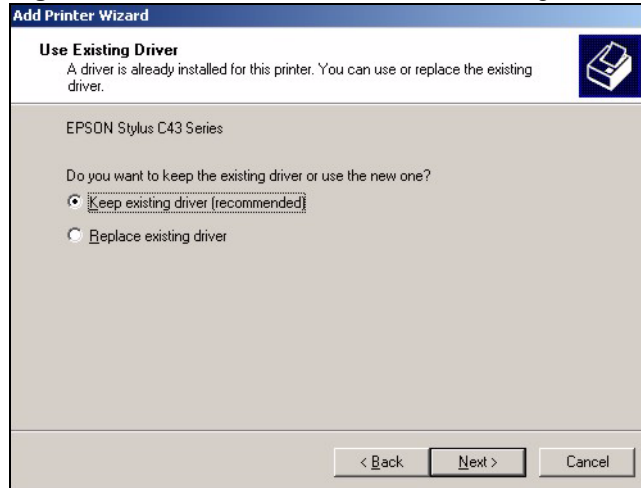

**10** Type a name to identify the printer and then click **Next** to continue.

**Figure 158** Add Printer Wizard: Name Your Printer

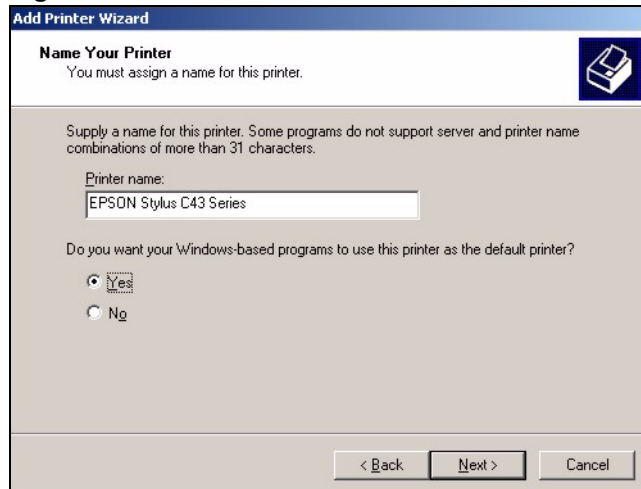

**11** The ZyXEL Device is a print server itself and you do not need to have your computer act as a print server by sharing the printer with other users in the same network; just select **Do not share this printer** and click **Next** to proceed to the following screen.

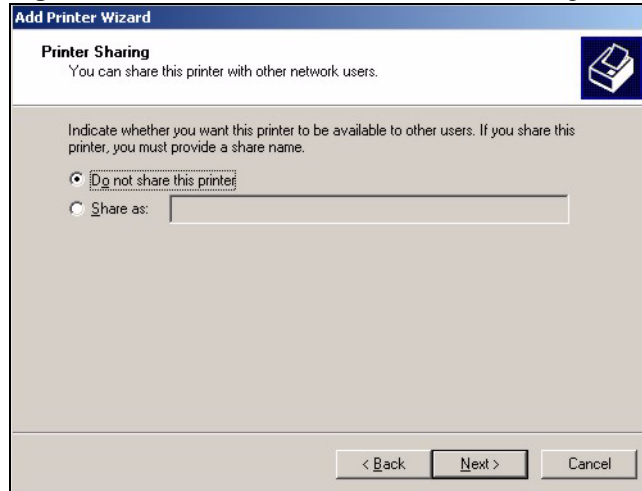
**Figure 159** Add Printer Wizard: Printer Sharing

**12** Select **Yes** and then click the **Next** button if you want to print a test page. A pop-up screen displays to ask if the test page printed correctly. Otherwise select **No** and then click **Next** to continue.

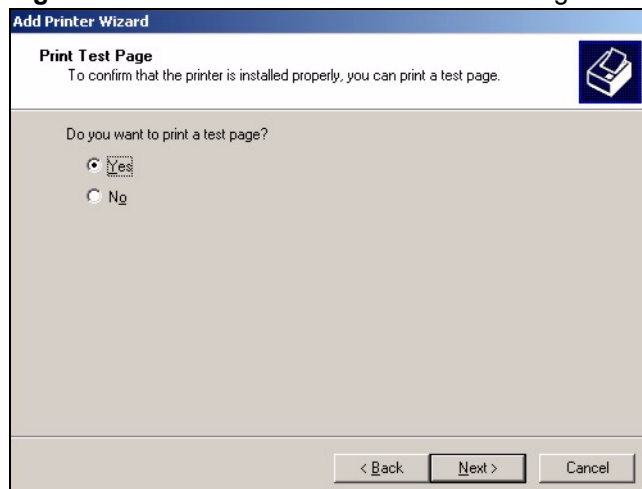
**Figure 160** Add Printer Wizard: Print Test Page

**13** The following screen shows your current printer settings. Select **Finish** to complete adding a new printer.

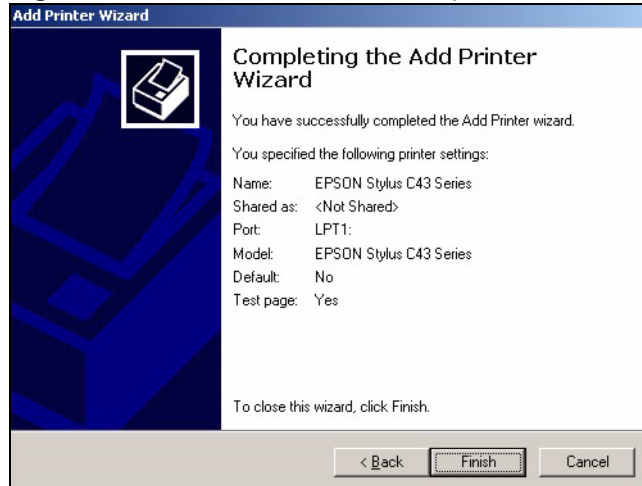
**Figure 161** Add Printer Wizard Complete

## 20.6 Macintosh OS X Adding Printer Example

Use the following steps to set up a print server driver on your Macintosh computer.

- 1 Click the **Print Center** icon  located in the Macintosh Dock (a place holding a series of icons/shortcuts at the bottom of the desktop). Proceed to step 6 to continue. If the **Print Center** icon is not in the Macintosh Dock, proceed to the next step.
- 2 On your desktop, double-click the **Macintosh HD** icon to open the **Macintosh HD** window.

**Figure 162** Macintosh HD

- 3 Double-click the **Applications** folder.

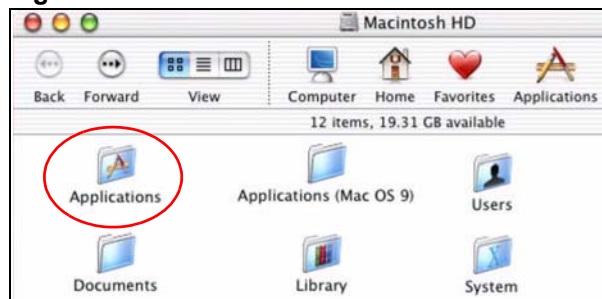
**Figure 163** Macintosh HD folder

- 4 Double-click the **Utilities** folder.

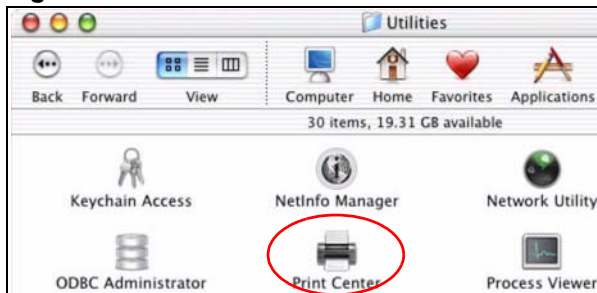

Figure 164 Applications Folder



5 Double-click the **Print Center** icon.

Figure 165 Utilities Folder



6 Click the **Add** icon at the top of the screen.

Figure 166 Printer List Folder

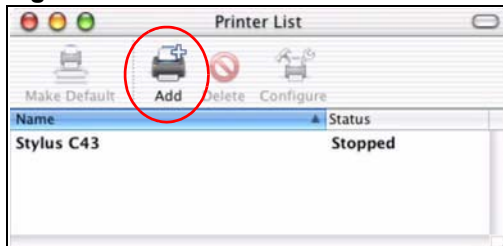

- 7 Set up your printer in the **Printer List** configuration screen. Select **IP Printing** from the drop-down list box.
- 8 In the **Printer's Address** field, type the IP address of your ZyXEL Device.
- 9 Deselect the **Use default queue on server** check box.
- 10 Type **LP1** (a parallel port) in the **Queue Name** field.
- 11 Select your **Printer Model** from the drop-down list box. If the printer's model is not listed, select **Generic**.

**Figure 167** Printer Configuration

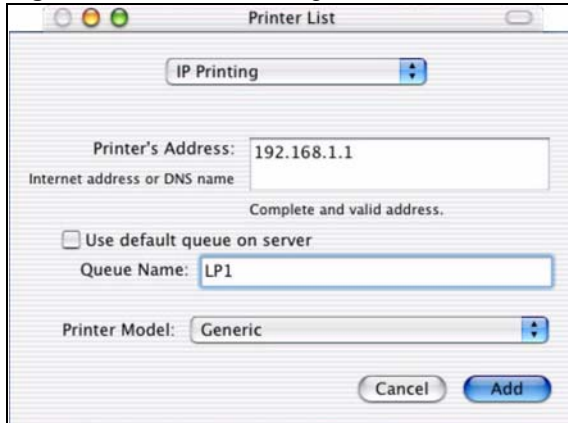

**12** Click **Add** to select a printer model, save and close the **Printer List** configuration screen.

**Figure 168** Printer Model

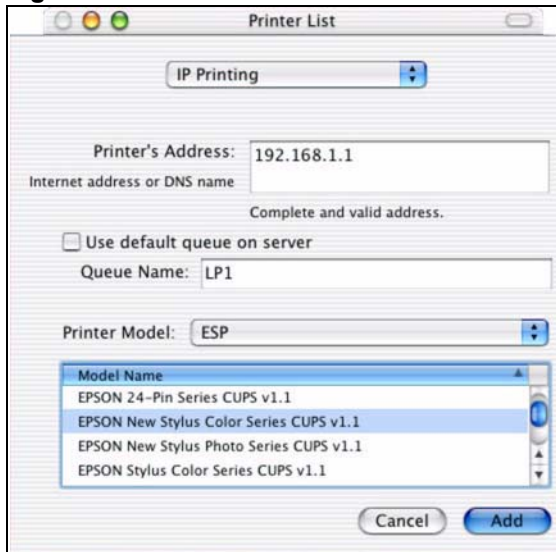

**13** The **Name LP1 on 192.168.1.1** displays in the **Printer List** field. The default printer **Name** displays in bold type.

**Figure 169** Print Server

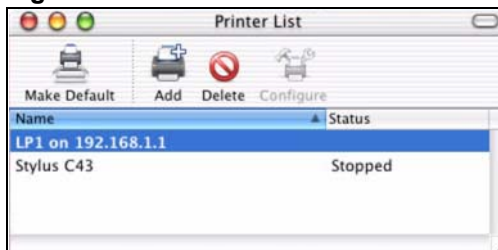

**14** Your Macintosh print server driver setup is complete. You can now use the ZyXEL Device's print server to print from a Macintosh computer.

# File Sharing

Use these screens to set up file sharing through your ZyXEL Device.

## 21.1 File Sharing Implementation Overview

Your ZyXEL Device allows you to connect USB 2.0 (or lower) file storage devices so that they can be accessed by users connected to your network. A file storage device can be a USB memory stick or a hard drive with a USB connector. The following figure is an overview of the ZyXEL Device's file server feature.



**File Allocation Table (FAT) and FAT32 file systems are the only file systems compatible with the file sharing feature.**

**Figure 170** File Sharing Overview

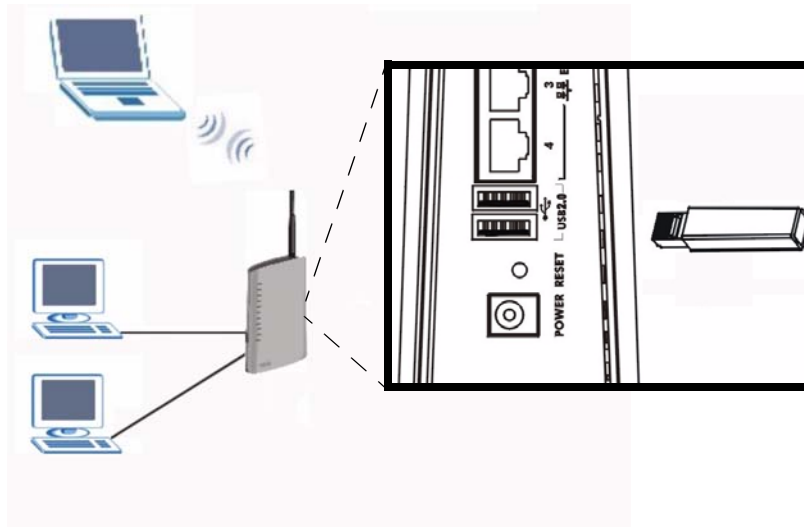

Do the following to set up file sharing via your ZyXEL Device:

- 1 Connect a USB memory stick (or a USB hard drive) to one of the ZyXEL Device's USB ports.
- 2 The ZyXEL Device detects the USB memory stick and makes its contents available for browsing. If you connect more than one device (or your hard drive has more than one

partition), each device (or partition) is given its own folder. These folders are called “shares”.

- 3 Configure a user account. Anyone who wants to access your shared files must enter a user name and password. See [Section 21.3 on page 245](#) for more information.

## 21.2 Sharing Files via the ZyXEL Device

The ZyXEL Device uses Common Internet File System (CIFS) protocol for its file sharing functions. CIFS protocol is supported on Microsoft Windows, Linux Samba and other operating systems (refer to your systems specifications for CIFS compatibility). CIFS compatible computers can access the USB file storage devices connected to the ZyXEL Device.

### 21.2.1 Using the Workgroup Name to Share Files

In order to use this method to share files you need to add the ZyXEL Device to the workgroup on the network to which your computer belongs. In a typical home network this workgroup name is “Workgroup”.



---

**The ZyXEL Device will not be accessible via the workgroup name if your local area network has restrictions set up that do not allow devices to join a workgroup. In this case, contact your network administrator.**

---

#### 21.2.1.1 Checking your Workgroup Name

You can check the name of the workgroup to which your computer belongs by viewing the **Network Identification** information of your Windows 2000 computer. Click **Start > Settings > Control Panel > System**. Select the **Network Identification** tab and note the workgroup name of your computer. This is the value you have to enter in the **Workgroup Name** field in the **File Sharing** screen.

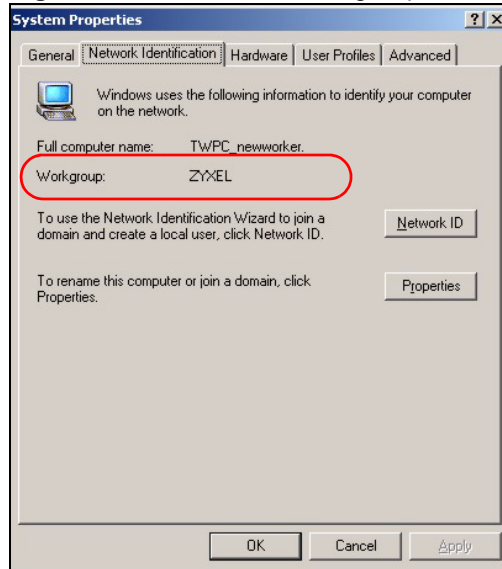
**Figure 171** Check the Workgroup Name

## 21.3 User Accounts

The ZyXEL Device requires that a user enter a user name and password in order to access files on the USB storage device. When you browse to the ZyXEL Device you are prompted for a user name and password before you can access files on the USB storage device.

**Figure 172** File Sharing Login

Once logged in, you do not have to re-login until you restart the computer, even if the administrator changes the username and password.

## 21.4 File Sharing - General Screen

Use this screen to set up file sharing via the ZyXEL Device. To access this screen, click **Management > File Sharing**.

**Figure 173** Management > File Sharing

The screenshot shows the 'General' tab of the File Sharing Management interface. It is divided into three sections: Server Configuration, User Configuration Setting, and Default Share Directory List.

**Server Configuration:**

- Enable File Sharing Services
- Workgroup Name: WORKGROUP
- System Code Page: cp437 (United States)

**User Configuration Setting:**

- Active
- User Name: user
- Password: [masked]
- Retype to Confirm: [masked]

**Default Share Directory List:**

#	Share Name	Share Directory
1	usbdisk1	/usbdisk1
2	usbdisk2	/usbdisk2

Buttons: Apply, Cancel

Each field is described in the following table.

**Table 104** Management > File Sharing

LABEL	DESCRIPTION
Enable File Sharing Services	Select this to enable file sharing through the ZyXEL Device.
Workgroup Name	You can add the ZyXEL Device to an existing workgroup on your network Type the name of an existing workgroup on your network. The ZyXEL Device automatically joins this workgroup and you can browse to it via Windows Explorer. See <a href="#">Section 21.2.1 on page 244</a> for more information.  <b>Note: If the workgroup name is not entered exactly the same as the workgroup name to which your computer belongs to, browsing via the network neighborhood will not work.</b>
System Code Page	Select the character set of the files contained on your storage device. For example, if your files were created on an operating system which used the Russian alphabet, select <b>cp866 (Russian)</b> . If the file or folder names on your USB storage device appear as unrecognizable (or jumbled) characters, you should double check this setting to make sure it is set correctly.
Active	Check or uncheck this box to activate or deactivate the user account.  <b>Note: If you deactivate the account, you deactivate the file sharing feature.</b>
User Name	Enter the user name of the account. The user name can be 31 alpha-numeric characters long.
Password	Enter the password for this account. The password can be 99 alpha-numeric characters long.
Retype to Confirm	Retype the password.

**Table 104** Management > File Sharing

LABEL	DESCRIPTION
Default Share Directory List	These fields identify the default shares on the ZyXEL Device.
#	This is a read-only index number of the default share on the ZyXEL Device. When more than one USB disk (or a USB hard drive with multiple shares) is connected to the ZyXEL Device this index number identifies the different disks. The first disk connected is 1, the second 2 and so on.
Share Name	This field displays the default share names on the ZyXEL Device. <b>usbdisk1</b> refers to the share name of the first USB memory disk connected to the ZyXEL Device, <b>usbdisk2</b> refers to the second USB memory disk connected to the ZyXEL Device and so on.
Share Directory	This field displays the share directories (folders) on the ZyXEL Device. These are the directories (folders) you can enter when you browse to your USB storage device.
Apply	Click this to save your changes to the ZyXEL Device.
Cancel	Click this to set every field in this screen to its last-saved value.

## 21.5 Accessing Files via the ZyXEL Device

Once you have enabled file sharing and configured a user account for file sharing. The USB file storage devices become a part of your file structure. There are three ways to start browsing the file storage devices connected to the ZyXEL Device.



---

**The examples in this User's Guide show you how to use Microsoft's Windows 2000 to browse your shared files. Refer to your operating system's documentation for how to browse your file structure.**

---

### 21.5.1 Using Windows Explorer to Share Files

CIFS protocol allows you to use the Windows Explorer to connect to the ZyXEL Device and access the file storage devices connected to it.

In Windows Explorer's Address bar type a double backslash “\\” followed by the IP address of the ZyXEL Device (the default IP address of the ZyXEL Device is 192.168.1.1) and hit [ENTER]. A screen asking for password authentication appears. Enter the user name and password and hit **OK**. See [Figure 174 on page 248](#).





---

**Once you login to the file “share” via your ZyXEL Device, you do not have to relogin until you restart your computer.**

---

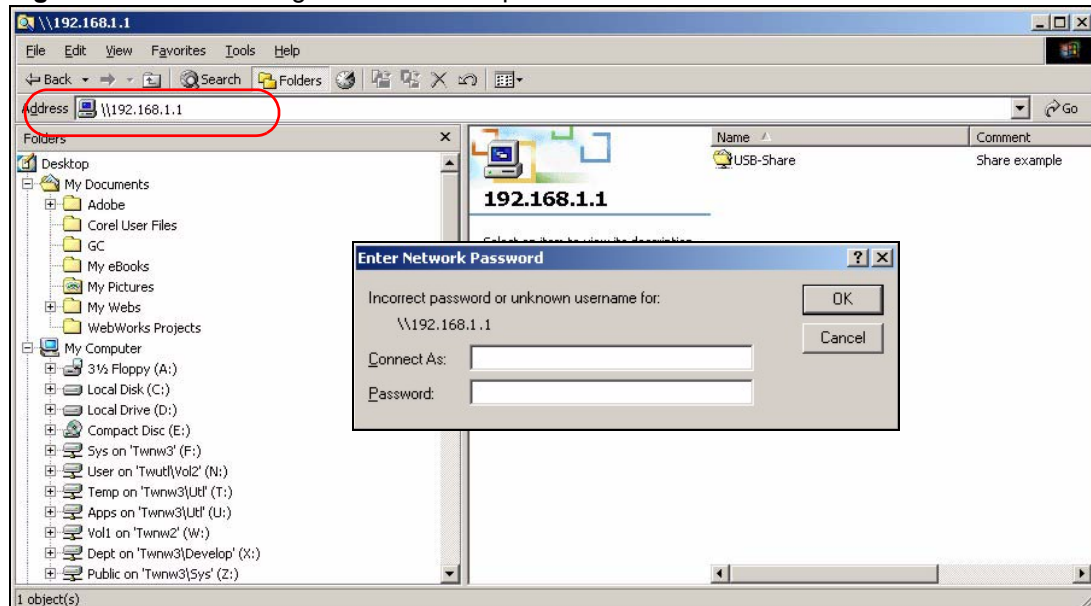
Figure 174 File Sharing via Windows Explorer



### 21.5.2 Using the Run Utility to Share Files

On your Windows 2000 computer, click **Start**, **Run** and type a double backslash “\\” followed by the IP address of the ZyXEL Device and click **OK**.

Figure 175 Run Utility to Browse Files

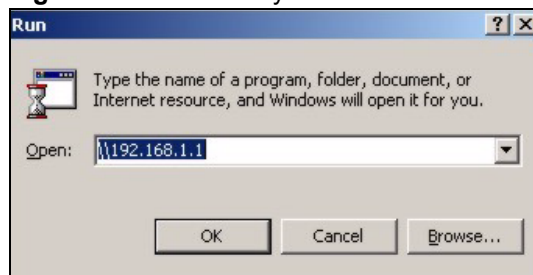

The **Run** utility automatically opens Windows Explorer and displays the contents of the USB storage device connected to your ZyXEL Device.

### 21.5.3 Using the Workgroup Name to Access Files

Before using this method to access files you need to make sure that you have correctly configured the workgroup name in the **File Sharing > General** screen. See [Section 21.2.1 on page 244](#) for more information.



**The ZyXEL Device will not be accessible via the workgroup name if your local area network has restrictions set up that do not allow devices to join a workgroup. In this case, contact your network administrator.**



Once the ZyXEL Device is a member of your workgroup, use Windows Explorer to browse to the file “share” by locating the workgroup in your file system. It is located under **My Network Places**. In our example the workgroup name is the default “Workgroup”.

**Figure 176** Browse to a File Share via Workgroup Name

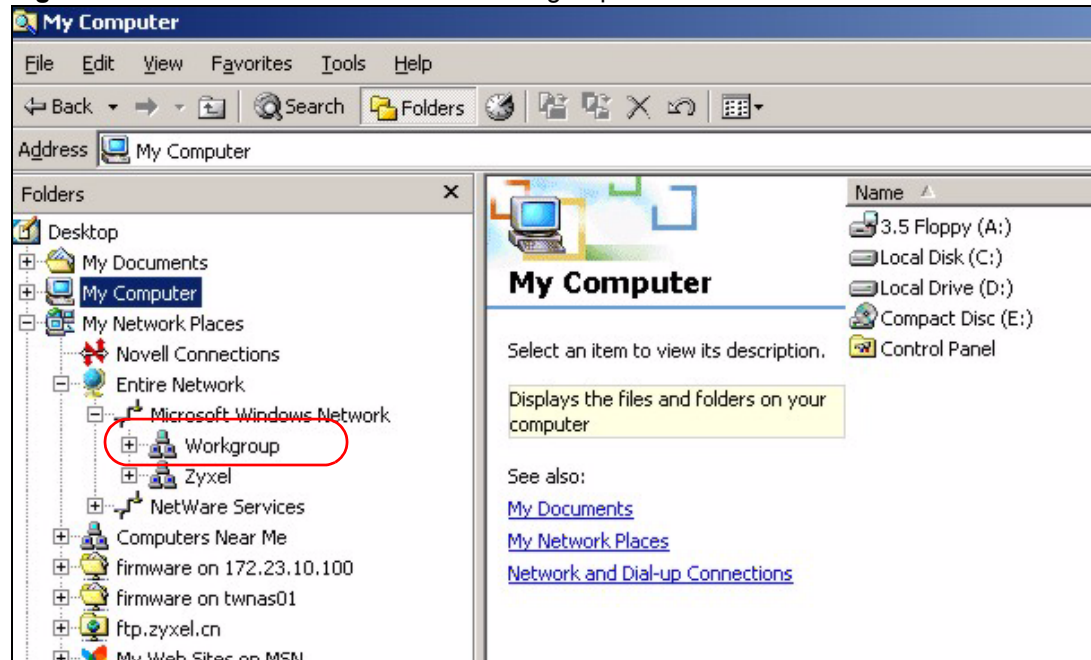



---

# PART VI

## Maintenance and Troubleshooting

---

System (253)  
Logs (261)  
Tools (273)  
Troubleshooting (279)



# System

Use this screen to set up general system settings, change the system mode, change the password, configure the DDNS server settings, and set the current date and time.

## 22.1 System Overview

### 22.1.1 System Name

**System Name** is for identification purposes. However, because some ISPs check this name you should enter your computer's "Computer Name".

- In Windows 95/98 click **Start, Settings, Control Panel, Network**. Click the **Identification** tab, note the entry for the **Computer Name** field and enter it as the **System Name**.
- In Windows 2000, click **Start, Settings** and **Control Panel** and then double-click **System**. Click the **Network Identification** tab and then the **Properties** button. Note the entry for the **Computer name** field and enter it as the **System Name**.
- In Windows XP, click **Start, My Computer, View system information** and then click the **Computer Name** tab. Note the entry in the **Full computer name** field and enter it as the ZyXEL Device **System Name**.

### 22.1.2 Domain Name

The **Domain Name** entry is what is propagated to the DHCP clients on the LAN. If you leave this blank, the domain name obtained by DHCP from the ISP is used. While you must enter the host name (System Name) on each individual computer, the domain name can be assigned from the ZyXEL Device via DHCP.

### 22.1.3 General System Screen

Use this screen to change the ZyXEL Device's mode, set up the ZyXEL Device's system name, domain name, idle timeout, and administrator password. To access this screen, click **Maintenance > System > General**.

**Figure 177** Maintenance > System > General

Each field is described in the following table.

**Table 105** Maintenance > System > General

LABEL	DESCRIPTION
System Setup	
System Name	Enter your computer's "Computer Name". This is for identification purposes, but some ISPs also check this field. This name can be up to 30 alphanumeric characters long. Spaces are not allowed, but dashes "-" and underscores "_" are accepted.
Domain Name	Enter the domain name entry that is propagated to DHCP clients on the LAN. If you leave this blank, the domain name obtained from the ISP is used. Use up to 38 alphanumeric characters. Spaces are not allowed, but dashes "-" and periods "." are accepted.
Administrator Inactivity Timer	Enter the number of minutes a management session can be left idle before the session times out. After it times out, you have to log in again. A value of "0" means a management session never times out, no matter how long it has been left idle. This is not recommended. Long idle timeouts may have security risks. The default is five minutes.
Password Setup	
Old Password	Enter the current password you use to access the ZyXEL Device.
New Password	Enter the new password for the ZyXEL Device. You can use up to 30 characters. As you type the password, the screen displays an asterisk (*) for each character you type.
Retype to Confirm	Type the new password again.
Apply	Click this to save your changes and to apply them to the ZyXEL Device.
Cancel	Click this to set every field in this screen to its last-saved value.

## 22.2 Dynamic DNS Overview

Use this screen to set up the ZyXEL Device as a dynamic DNS client.

## 22.2.1 DNS Server Address Assignment

Use DNS (Domain Name System) to map a domain name to its corresponding IP address and vice versa, for instance, the IP address of [www.zyxel.com](http://www.zyxel.com) is 204.217.0.2. The DNS server is extremely important because without it, you must know the IP address of a computer before you can access it.

The ZyXEL Device can get the DNS server addresses in the following ways.

- 1 The ISP tells you the DNS server addresses, usually in the form of an information sheet, when you sign up. If your ISP gives you DNS server addresses, enter them in the **DNS Server** fields in the **SYSTEM General** screen.
- 2 If the ISP did not give you DNS server information, leave the **DNS Server** fields in the **SYSTEM General** screen set to 0.0.0.0 for the ISP to dynamically assign the DNS server IP addresses.

## 22.2.2 Dynamic DNS

Dynamic DNS allows you to update your current dynamic IP address with one or many dynamic DNS services so that anyone can contact you (in NetMeeting, CU-SeeMe, etc.). You can also access your FTP server or Web site on your own computer using a domain name (for instance [myhost.dns.org](http://myhost.dns.org), where [myhost](http://myhost) is a name of your choice) that will never change instead of using an IP address that changes each time you reconnect. Your friends or relatives will always be able to call you even if they don't know your IP address.

First of all, you need to have registered a dynamic DNS account with [www.dyndns.org](http://www.dyndns.org). This is for people with a dynamic IP from their ISP or DHCP server that would still like to have a domain name. The Dynamic DNS service provider will give you a password or key.

Enabling the wildcard feature for your host causes [\\*.yourhost.dyndns.org](http://*.yourhost.dyndns.org) to be aliased to the same IP address as [yourhost.dyndns.org](http://yourhost.dyndns.org). This feature is useful if you want to be able to use, for example, [www.yourhost.dyndns.org](http://www.yourhost.dyndns.org) and still reach your hostname.



---

**If you have a private WAN IP address, then you cannot use Dynamic DNS.**

---

## 22.2.3 Dynamic DNS Screen

To access this screen, click **Maintenance > System > Dynamic DNS**.

**Figure 178** Maintenance > System > Dynamic DNS

Each field is described in the following table.

**Table 106** Maintenance > System > Dynamic DNS

LABEL	DESCRIPTION
Dynamic DNS Setup	
Enable Dynamic DNS	Select this to use dynamic DNS.
Service Provider	Select the name of your Dynamic DNS service provider.
Dynamic DNS Type	Select the type of service that you are registered for from your Dynamic DNS service provider.
Host Name	Enter the host name. You can specify up to two host names, separated by a comma (",").
User Name	Enter your user name.
Password	Enter the password assigned to you.
Enable Wildcard Option	Select this to enable the DynDNS Wildcard feature.
Enable offline option	This field is available when <b>CustomDNS</b> is selected in the <b>DDNS Type</b> field. Select this if your Dynamic DNS service provider redirects traffic to a URL that you can specify while you are off line. Check with your Dynamic DNS service provider.
IP Address Update Policy	
Use WAN IP Address	Select this if you want the ZyXEL Device to update the domain name with the WAN port's IP address.



**Table 106** Maintenance > System > Dynamic DNS

LABEL	DESCRIPTION
Dynamic DNS server auto detect IP address	Select this if you want the DDNS server to update the IP address of the host name(s) automatically. Select this option when there are one or more NAT routers between the ZyXEL Device and the DDNS server.  <b>Note: The DDNS server may not be able to detect the proper IP address if there is an HTTP proxy server between the ZyXEL Device and the DDNS server.</b>
Use specified IP address	Select this if you want to use the specified IP address with the host name(s). Then, specify the IP address. Use this option if you have a static IP address.
Apply	Click this to save your changes and to apply them to the ZyXEL Device.
Reset	Click this to set every field in this screen to its last-saved value.

## 22.3 Time Setting Overview

Use this screen to set the date, time, and time zone in the ZyXEL Device.

### 22.3.1 Pre-defined NTP Time Servers List

The ZyXEL Device uses the following pre-defined list of NTP time servers if you do not specify a time server or it cannot synchronize with the time server you specified.



**The ZyXEL Device can use this pre-defined list of time servers regardless of the Time Protocol you select.**

When the ZyXEL Device uses the pre-defined list of NTP time servers, it randomly selects one server and tries to synchronize with it. If the synchronization fails, then the ZyXEL Device goes through the rest of the list in order from the first one tried until either it is successful or all the pre-defined NTP time servers have been tried.

**Table 107** Pre-defined NTP Time Servers

ntp1.cs.wisc.edu
ntp1.gbg.netnod.se
ntp2.cs.wisc.edu
tock.usno.navy.mil
ntp3.cs.wisc.edu
ntp.cs.strath.ac.uk
ntp1.sp.se
time1.stupi.se
tick.stdtime.gov.tw
tock.stdtime.gov.tw
time.stdtime.gov.tw

## 22.3.2 Resetting the Time

The ZyXEL Device resets the time in the following instances:

- When the ZyXEL Device starts up.
- When you click **Apply** in the [Time Setting Overview](#).
- 24-hour intervals after starting.

## 22.3.3 Time Settings Screen

To access this screen, click **Maintenance > System > Time Setting**.

**Figure 179** Maintenance > System > Time Setting

Each field is described in the following table.

**Table 108** Maintenance > System > Time Setting

LABEL	DESCRIPTION
Current Time and Date	This section displays the current date and time.
Time and Date Setup	
Manual	Select this if you want to specify the current date and time in the fields below.
New Time	Enter the new time in this field, and click <b>Apply</b> .
New Date	Enter the new date in this field, and click <b>Apply</b> .
Get from Time Server	Select this if you want to use a time server to update the current date and time in the ZyXEL Device.

**Table 108** Maintenance > System > Time Setting

LABEL	DESCRIPTION
Time Protocol	Select the time service protocol that your time server uses. Check with your ISP or network administrator, or use trial-and-error to find a protocol that works. <b>Daytime (RFC 867)</b> - This format is day/month/year/time zone. <b>Time (RFC 868)</b> - This format displays a 4-byte integer giving the total number of seconds since 1970/1/1 at 0:0:0. <b>NTP (RFC 1305)</b> - This format is similar to Time (RFC 868).
Time Server Address	Enter the IP address or URL of your time server. Check with your ISP or network administrator if you are unsure of this information.
Time Zone Setup	
Time Zone	Select the time zone at your location.
Daylight Savings	Select this if your location uses daylight savings time. Daylight savings is a period from late spring to early fall when many places set their clocks ahead of normal local time by one hour to give more daytime light in the evening.
Start Date	Enter which hour on which day of which week of which month daylight-savings time starts.
End Date	Enter which hour on the which day of which week of which month daylight-savings time ends.
Apply	Click this to save your changes and to apply them to the ZyXEL Device.
Cancel	Click this to set every field in this screen to its last-saved value.



Use these screens to look at log entries and alerts and to configure the ZyXEL Device's log and alert settings.

## 23.1 Logs Overview

For a list of log messages, see [Section 23.3 on page 265](#).

### 23.1.1 Alerts

An alert is a type of log that warrants more serious attention. Some categories such as **System Errors** consist of both logs and alerts.

### 23.1.2 Syslog Logs

There are two types of syslog: event logs and traffic logs. The device generates an event log when a system event occurs, for example, when a user logs in or the device is under attack. The device generates a traffic log when a "session" is terminated. A traffic log summarizes the session's type, when it started and stopped the amount of traffic that was sent and received and so on. An external log analyzer can reconstruct and analyze the traffic flowing through the device after collecting the traffic logs.

**Table 109** Syslog Logs

LOG MESSAGE	DESCRIPTION
Event Log: <Facility*8 + Severity>Mon dd hr:mm:ss hostname src="<srcIP:srcPort>" dst="<dstIP:dstPort>" msg="<msg>" note="<note>" devID="<mac address>" cat="<category>"	This message is sent by the system ("RAS" displays as the system name if you haven't configured one) when the router generates a syslog. The facility is defined in the <b>Log Settings</b> screen. The severity is the log's syslog class. The definition of messages and notes are defined in the various log charts throughout this chapter. The "devID" is the MAC address of the router's LAN port. The "cat" is the same as the category in the router's logs.
Traffic Log: <Facility*8 + Severity>Mon dd hr:mm:ss hostname src="<srcIP:srcPort>" dst="<dstIP:dstPort>" msg="Traffic Log" note="Traffic Log" devID="<mac address>" cat="Traffic Log" duration=seconds sent=sentBytes rcvd=receiveBytes dir="<from:to>" protoID=IPProtocolID proto="serviceName"	This message is sent by the device when the connection (session) is closed. The facility is defined in the Log Settings screen. The severity is the traffic log type. The message and note always display "Traffic Log". The "proto" field lists the service name. The "dir" field lists the incoming and outgoing interfaces ("LAN:LAN", "LAN:WAN", "LAN:DEV" for example).

## 23.2 Logs Screens

### 23.2.1 View Log Screen

Use this screen to look at log entries and alerts. Alerts are written in red. To access this screen, click **Maintenance > Logs > View Log**.

**Figure 180** Maintenance > Logs > View Log

The screenshot shows the 'View Log' screen with a 'Log Settings' tab. Below the tabs, there is a 'Display:' dropdown menu set to 'All Logs', and three buttons: 'Email Log Now', 'Refresh', and 'Clear Log'. The main content is a table with the following data:

#	Time	Message	Source	Destination	Note
1	01/01/2000 00:14:04	Successful WEB login	192.168.1.33		User:admin
2	01/01/2000 00:02:02	Successful WEB login	192.168.1.33		User:admin
3	01/01/2000 00:01:43	DHCP server assigns 192.168.1.33 to tw11477-02			
4	01/01/2000 00:01:40	DHCP server assigns 192.168.1.33 to tw11477-02			
5	01/01/2000 00:01:37	DHCP server assigns 192.168.1.33 to tw11477-02			

Click a column header to sort log entries in descending (later-to-earlier) order. Click again to sort in ascending order. The small triangle next to a column header indicates how the table is currently sorted (pointing downward is descending; pointing upward is ascending). Each field is described in the following table.

**Table 110** Maintenance > Logs > View Log

LABEL	DESCRIPTION
Display	Select a category whose log entries you want to view. To view all logs, select <b>All Logs</b> . The list of categories depends on what log categories are selected in the <b>Log Settings</b> page.
Email Log Now	Click this to send the log screen to the e-mail address specified in the <b>Log Settings</b> page.
Refresh	Click <b>Refresh</b> to renew the log screen.
Clear Log	Click <b>Clear Log</b> to clear all the log entries, regardless of what is shown on the log screen.
#	This field is a sequential value, and it is not associated with a specific log entry.
Time	This field displays the time the log was recorded.
Message	This field displays the reason for the log. See <a href="#">Section 23.3 on page 265</a> .
Source	This field displays the source IP address and the port number of the incoming packet. In many cases, some or all of this information may not be available.
Destination	This field lists the destination IP address and the port number of the incoming packet. In many cases, some or all of this information may not be available.
Note	This field displays additional information about the log entry.

## 23.2.2 Log Settings Screen

Use this screen to configure where the ZyXEL Device sends logs and alerts, the schedule for sending logs, and which logs and alerts are sent or recorded.

To access this screen, click **Maintenance > Logs > Log Settings**.

**Figure 181** Maintenance > Logs > Log Settings

Each field is described in the following table.

**Table 111** Maintenance > Logs > Log Settings

LABEL	DESCRIPTION
E-mail Log Settings	
Mail Server	Enter the server name or the IP address of the mail server the ZyXEL Device should use to e-mail logs and alerts. Leave this field blank if you do not want to send logs or alerts by e-mail.

**Table 111** Maintenance > Logs > Log Settings

LABEL	DESCRIPTION
Mail Subject	Enter the subject line used in e-mail messages the ZyXEL Device sends.
Send Log to	Enter the e-mail address to which log entries are sent by e-mail. Leave this field blank if you do not want to send logs by e-mail.
Send Alerts to	Enter the e-mail address to which alerts are sent by e-mail. Leave this field blank if you do not want to send alerts by e-mail.
Log Schedule	<p>Select the frequency with which the ZyXEL Device should send log messages by e-mail.</p> <ul style="list-style-type: none"> <li>• Daily</li> <li>• Weekly</li> <li>• Hourly</li> <li>• When Log is Full</li> <li>• None.</li> </ul> <p>If the <b>Weekly</b> or the <b>Daily</b> option is selected, specify a time of day when the E-mail should be sent. If the <b>Weekly</b> option is selected, then also specify which day of the week the E-mail should be sent. If the <b>When Log is Full</b> option is selected, an alert is sent when the log fills up. If you select <b>None</b>, no log messages are sent.</p>
Day for Sending Log	This field is only available when you select <b>Weekly</b> in the <b>Log Schedule</b> field. Select which day of the week to send the logs.
Time for Sending Log	<p>This field is only available when you select <b>Daily</b> or <b>Weekly</b> in the <b>Log Schedule</b> field.</p> <p>Enter the time of day in 24-hour format (for example 23:00 equals 11:00 pm) to send the logs.</p>
Clear log after sending mail	Select this to clear all logs and alert messages after logs are sent by e-mail.
Syslog Logging	Syslog logging sends a log to an external syslog server used to store logs.
Active	Select this to enable syslog logging.
Syslog Server IP Address	Enter the server name or IP address of the syslog server that logs the selected categories of logs.
Log Facility	Select a location. The log facility allows you to log the messages in different files in the syslog server. See the documentation of your syslog server for more details.
Active Log and Alert	
Log	Select the categories of logs that you want to record.
Send immediate alert	Select the categories of alerts that you want the ZyXEL Device to send immediately.
Apply	Click this to save your changes and to apply them to the ZyXEL Device.
Cancel	Click this to set every field in this screen to its last-saved value.



## 23.3 Log Message Descriptions

The following tables provide descriptions of example log messages.

**Table 112** System Error Logs

LOG MESSAGE	DESCRIPTION
WAN connection is down.	The WAN connection is down. You cannot access the network through this interface.
%s exceeds the max. number of session per host!	This attempt to create a NAT session exceeds the maximum number of NAT session table entries allowed to be created per host.

**Table 113** System Maintenance Logs

LOG MESSAGE	DESCRIPTION
Time synchronization is successful	The device has adjusted its time based on information from the time server.
Time synchronization failed	The device failed to get information from the time server.
WAN interface gets IP: %s	The WAN interface got a new IP address from the DHCP or PPPoE server.
DHCP client IP expired	A DHCP client's IP address has expired.
DHCP server assigns %s	The DHCP server assigned an IP address to a client.
Successful WEB login	Someone has logged on to the device's web configurator interface.
WEB login failed	Someone has failed to log on to the device's web configurator interface.
Successful TELNET login	Someone has logged on to the router via telnet.
TELNET login failed	Someone has failed to log on to the router via telnet.
Successful FTP login	Someone has logged on to the device via ftp.
FTP login failed	Someone has failed to log on to the device via ftp.
NAT Session Table is Full!	The maximum number of NAT session table entries has been exceeded and the table is full.
Time initialized by Datetime server: %s	The device got the time and date from the Datetime server.
Time initialized by Time server	The device got the time and date from the time server.
Time initialized by NTP server	The device got the time and date from the NTP server.
Failed to sync with Daytime server: %s	The device was not able to connect to the Daytime server.
Failed to sync with Time server: %s	The device was not able to connect to the Time server.
Failed to sync with NTP server: %s	The device was not able to connect to the NTP server.

**Table 113** System Maintenance Logs (continued)

LOG MESSAGE	DESCRIPTION
Too large ICMP packet has been dropped	The device dropped an ICMP packet that was too large.
Configuration Change: PC = 0x%x, Task ID = 0x%x	The device is saving configuration changes.

**Table 114** Access Control Logs

LOG MESSAGE	DESCRIPTION
Firewall default policy: [ TCP   UDP   IGMP   ESP   GRE   OSPF ] <Packet Direction>	Attempted TCP/UDP/IGMP/ESP/GRE/OSPF access matched the default policy and was blocked or forwarded according to the default policy's setting.
Firewall rule [NOT] match:[ TCP   UDP   IGMP   ESP   GRE   OSPF ] <Packet Direction>, <rule:%d>	Attempted TCP/UDP/IGMP/ESP/GRE/OSPF access matched (or did not match) a configured firewall rule (denoted by its number) and was blocked or forwarded according to the rule.
Triangle route packet forwarded: [ TCP   UDP   IGMP   ESP   GRE   OSPF ]	The firewall allowed a triangle route session to pass through.
Packet without a NAT table entry blocked: [ TCP   UDP   IGMP   ESP   GRE   OSPF ]	The router blocked a packet that didn't have a corresponding NAT table entry.
Router sent blocked web site message: TCP	The router sent a message to notify a user that the router blocked access to a web site that the user requested.
Exceed maximum sessions per host (%d).	The device blocked a session because the host's connections exceeded the maximum sessions per host.

**Table 115** TCP Reset Logs

LOG MESSAGE	DESCRIPTION
Under SYN flood attack, sent TCP RST	The router sent a TCP reset packet when a host was under a SYN flood attack (the TCP incomplete count is per destination host.)
Exceed TCP MAX incomplete, sent TCP RST	The router sent a TCP reset packet when the number of TCP incomplete connections exceeded the user configured threshold. (the TCP incomplete count is per destination host.)
Peer TCP state out of order, sent TCP RST	The router sent a TCP reset packet when a TCP connection state was out of order. Note: The firewall refers to RFC793 Figure 6 to check the TCP state.
Firewall session time out, sent TCP RST	The router sent a TCP reset packet when a dynamic firewall session timed out. The default timeout values are as follows: ICMP idle timeout: 3 minutes UDP idle timeout: 3 minutes TCP connection (three way handshaking) timeout: 270 seconds TCP FIN-wait timeout: 2 MSL (Maximum Segment Lifetime set in the TCP header). TCP idle (established) timeout (s): 150 minutes TCP reset timeout: 10 seconds

**Table 115** TCP Reset Logs (continued)

LOG MESSAGE	DESCRIPTION
Exceed MAX incomplete, sent TCP RST	The router sent a TCP reset packet when the number of incomplete connections (TCP and UDP) exceeded the user-configured threshold. (Incomplete count is for all TCP and UDP connections through the firewall.)Note: When the number of incomplete connections (TCP + UDP) > "Maximum Incomplete High", the router sends TCP RST packets for TCP connections and destroys TOS (firewall dynamic sessions) until incomplete connections < "Maximum Incomplete Low".
Access block, sent TCP RST	The router sends a TCP RST packet and generates this log if you turn on the firewall TCP reset mechanism (via CLI command: <code>sys firewall tcprst</code> ).

**Table 116** Packet Filter Logs

LOG MESSAGE	DESCRIPTION
[ TCP   UDP   ICMP   IGMP   Generic ] packet filter matched (set: %d, rule: %d)	Attempted access matched a configured filter rule (denoted by its set and rule number) and was blocked or forwarded according to the rule.

For type and code details, see [Table 123 on page 270](#).

**Table 117** ICMP Logs

LOG MESSAGE	DESCRIPTION
Firewall default policy: ICMP <Packet Direction>, <type:%d>, <code:%d>	ICMP access matched the default policy and was blocked or forwarded according to the user's setting.
Firewall rule [NOT] match: ICMP <Packet Direction>, <rule:%d>, <type:%d>, <code:%d>	ICMP access matched (or didn't match) a firewall rule (denoted by its number) and was blocked or forwarded according to the rule.
Triangle route packet forwarded: ICMP	The firewall allowed a triangle route session to pass through.
Packet without a NAT table entry blocked: ICMP	The router blocked a packet that didn't have a corresponding NAT table entry.
Unsupported/out-of-order ICMP: ICMP	The firewall does not support this kind of ICMP packets or the ICMP packets are out of order.
Router reply ICMP packet: ICMP	The router sent an ICMP reply packet to the sender.

**Table 118** PPP Logs

LOG MESSAGE	DESCRIPTION
ppp:LCP Starting	The PPP connection's Link Control Protocol stage has started.
ppp:LCP Opening	The PPP connection's Link Control Protocol stage is opening.
ppp:CHAP Opening	The PPP connection's Challenge Handshake Authentication Protocol stage is opening.
ppp:IPCP Starting	The PPP connection's Internet Protocol Control Protocol stage is starting.
ppp:IPCP Opening	The PPP connection's Internet Protocol Control Protocol stage is opening.

**Table 118** PPP Logs (continued)

LOG MESSAGE	DESCRIPTION
ppp:LCP Closing	The PPP connection's Link Control Protocol stage is closing.
ppp:IPCP Closing	The PPP connection's Internet Protocol Control Protocol stage is closing.

**Table 119** UPnP Logs

LOG MESSAGE	DESCRIPTION
UPnP pass through Firewall	UPnP packets can pass through the firewall.

**Table 120** Content Filtering Logs

LOG MESSAGE	DESCRIPTION
%s: Keyword blocking	The content of a requested web page matched a user defined keyword.
%s: Not in trusted web list	The web site is not in a trusted domain, and the router blocks all traffic except trusted domain sites.
%s: Forbidden Web site	The web site is in the forbidden web site list.
%s: Contains ActiveX	The web site contains ActiveX.
%s: Contains Java applet	The web site contains a Java applet.
%s: Contains cookie	The web site contains a cookie.
%s: Proxy mode detected	The router detected proxy mode in the packet.
%s: Trusted Web site	The web site is in a trusted domain.
Cannot get the IP address of content filtering external database via DNS query.	The ZyXEL Device cannot get the IP address of the external content filtering via DNS query.
External content filtering license key is invalid.	The external content filtering license key is invalid.

For type and code details, see [Table 123 on page 270](#).

**Table 121** Attack Logs

LOG MESSAGE	DESCRIPTION
attack [ TCP   UDP   IGMP   ESP   GRE   OSPF ]	The firewall detected a TCP/UDP/IGMP/ESP/GRE/OSPF attack.
attack ICMP (type:%d, code:%d)	The firewall detected an ICMP attack.
land [ TCP   UDP   IGMP   ESP   GRE   OSPF ]	The firewall detected a TCP/UDP/IGMP/ESP/GRE/OSPF land attack.
land ICMP (type:%d, code:%d)	The firewall detected an ICMP land attack.

**Table 121** Attack Logs (continued)

LOG MESSAGE	DESCRIPTION
ip spoofing - WAN [ TCP   UDP   IGMP   ESP   GRE   OSPF ]	The firewall detected an IP spoofing attack on the WAN port.
ip spoofing - WAN ICMP (type:%d, code:%d)	The firewall detected an ICMP IP spoofing attack on the WAN port.
icmp echo : ICMP (type:%d, code:%d)	The firewall detected an ICMP echo attack.
syn flood TCP	The firewall detected a TCP syn flood attack.
ports scan TCP	The firewall detected a TCP port scan attack.
teardrop TCP	The firewall detected a TCP teardrop attack.
teardrop UDP	The firewall detected an UDP teardrop attack.
teardrop ICMP (type:%d, code:%d)	The firewall detected an ICMP teardrop attack.
illegal command TCP	The firewall detected a TCP illegal command attack.
NetBIOS TCP	The firewall detected a TCP NetBIOS attack.
ip spoofing - no routing entry [ TCP   UDP   IGMP   ESP   GRE   OSPF ]	The firewall classified a packet with no source routing entry as an IP spoofing attack.
ip spoofing - no routing entry ICMP (type:%d, code:%d)	The firewall classified an ICMP packet with no source routing entry as an IP spoofing attack.
vulnerability ICMP (type:%d, code:%d)	The firewall detected an ICMP vulnerability attack.
traceroute ICMP (type:%d, code:%d)	The firewall detected an ICMP traceroute attack.
ports scan UDP	The firewall detected a UDP port scan attack.
Firewall sent TCP packet in response to DoS attack TCP	The firewall sent TCP packet in response to a DoS attack
ICMP Source Quench ICMP	The firewall detected an ICMP Source Quench attack.
ICMP Time Exceed ICMP	The firewall detected an ICMP Time Exceed attack.
ICMP Destination Unreachable ICMP	The firewall detected an ICMP Destination Unreachable attack.
ping of death. ICMP	The firewall detected an ICMP ping of death attack.
smurf ICMP	The firewall detected an ICMP smurf attack.

**Table 122** Remote Management Logs

LOG MESSAGE	DESCRIPTION
Remote Management: FTP denied	Attempted use of FTP service was blocked according to remote management settings.
Remote Management: TELNET denied	Attempted use of TELNET service was blocked according to remote management settings.

**Table 122** Remote Management Logs

LOG MESSAGE	DESCRIPTION
Remote Management: HTTP or UPnP denied	Attempted use of HTTP or UPnP service was blocked according to remote management settings.
Remote Management: WWW denied	Attempted use of WWW service was blocked according to remote management settings.
Remote Management: HTTPS denied	Attempted use of HTTPS service was blocked according to remote management settings.
Remote Management: SSH denied	Attempted use of SSH service was blocked according to remote management settings.
Remote Management: ICMP Ping response denied	Attempted use of ICMP service was blocked according to remote management settings.
Remote Management: DNS denied	Attempted use of DNS service was blocked according to remote management settings.

**Table 123** ICMP Notes

TYPE	CODE	DESCRIPTION
0		Echo Reply
	0	Echo reply message
3		Destination Unreachable
	0	Net unreachable
	1	Host unreachable
	2	Protocol unreachable
	3	Port unreachable
	4	A packet that needed fragmentation was dropped because it was set to Don't Fragment (DF)
	5	Source route failed
4		Source Quench
	0	A gateway may discard internet datagrams if it does not have the buffer space needed to queue the datagrams for output to the next network on the route to the destination network.
5		Redirect
	0	Redirect datagrams for the Network
	1	Redirect datagrams for the Host
	2	Redirect datagrams for the Type of Service and Network
	3	Redirect datagrams for the Type of Service and Host
8		Echo
	0	Echo message
11		Time Exceeded
	0	Time to live exceeded in transit
	1	Fragment reassembly time exceeded
12		Parameter Problem
	0	Pointer indicates the error

**Table 123** ICMP Notes (continued)

TYPE	CODE	DESCRIPTION
13		Timestamp
	0	Timestamp request message
14		Timestamp Reply
	0	Timestamp reply message
15		Information Request
	0	Information request message
16		Information Reply
	0	Information reply message

**Table 124** SIP Logs

LOG MESSAGE	DESCRIPTION
SIP Registration Success by SIP:SIP Phone Number	The listed SIP account was successfully registered with a SIP register server.
SIP Registration Fail by SIP:SIP Phone Number	An attempt to register the listed SIP account with a SIP register server was not successful.
SIP UnRegistration Success by SIP:SIP Phone Number	The listed SIP account's registration was deleted from the SIP register server.
SIP UnRegistration Fail by SIP:SIP Phone Number	An attempt to delete the listed SIP account's registration from the SIP register server failed.

**Table 125** RTP Logs

LOG MESSAGE	DESCRIPTION
Error, RTP init fail	The initialization of an RTP session failed.
Error, Call fail: RTP connect fail	A VoIP phone call failed because the RTP session could not be established.
Error, RTP connection cannot close	The termination of an RTP session failed.

**Table 126** Lifeline Logs

LOG MESSAGE	DESCRIPTION
PSTN Call Start	A PSTN call has been initiated.
PSTN Call End	A PSTN call has terminated.
PSTN Call Established	A PSTN call has been set up.





Use these screens to upload new firmware, back up and restore the configuration, and restart the ZyXEL Device.

## 24.1 Tools Overview

### 24.1.1 ZyXEL Firmware

Find firmware at [www.zyxel.com](http://www.zyxel.com) in a file that (usually) uses the system model name with a ".bin" extension, e.g., "ZyXEL Device.bin". The upload process uses HTTP (Hypertext Transfer Protocol) and may take up to two minutes. After a successful upload, the system will reboot.

## 24.2 Tools Screens

### 24.2.1 Firmware Screen

Use this screen to upload new firmware to the ZyXEL Device. To access this screen, click **Maintenance > Tools > Firmware**.



**Only use firmware for your ZyXEL Device's specific model. Refer to the label on the bottom of your ZyXEL Device.**

**Figure 182** Maintenance > Tools > Firmware

**Firmware** Configuration Restart

**Firmware Upgrade**

To upgrade the internal router firmware, browse to the location of the binary (.BIN) upgrade file and click **Upload**. Upgrade files can be downloaded from website. If the upgrade file is compressed (.ZIP file), you must first extract the binary (.BIN) file. In some cases, you may need to reconfigure

File Path:  Browse...

Upload

Each field is described in the following table.

**Table 127** Maintenance > Tools > Firmware

LABEL	DESCRIPTION
File Path	Enter the location of the .bin file you want to upload, or click <b>Browse...</b> to find it. You must decompress compressed (.zip) files before you can upload them.
Browse...	Click this to find the .bin file you want to upload.
Upload	Click this to begin uploading the selected file. This may take up to two minutes. See <a href="#">Section 24.2.2 on page 274</a> for more information about this process.  <b>Note: Do not turn off the device while firmware upload is in progress!</b>

## 24.2.2 Firmware Upload Screens



**Do not turn off the device while firmware upload is in progress!**

When the ZyXEL Device starts to upload firmware, the **Firmware Upload in Process** screen appears.

**Figure 183** Firmware Upload In Process



The process usually takes about two minutes. The device automatically restarts in this time. This causes a temporary network disconnect. In some operating systems, you may see the following icon on your desktop.

**Figure 184** Network Temporarily Disconnected

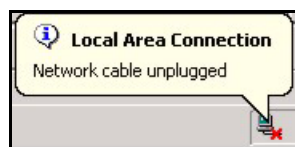

After two minutes, log in again, and check your new firmware version in the **Status** screen. You might have to open a new browser to log in.

If the upload is not successful, the following screen appears.

**Figure 185** Firmware Upload Error



Click **Return** to go back to the [Firmware Screen](#).

### 24.2.3 Configuration Screen

Use this screen to back up or restore the configuration of the ZyXEL Device. You can also use this screen to reset the ZyXEL Device to the factory default settings. To access this screen, click **Maintenance > Tools > Configuration**.

**Figure 186** Maintenance > Tools > Configuration

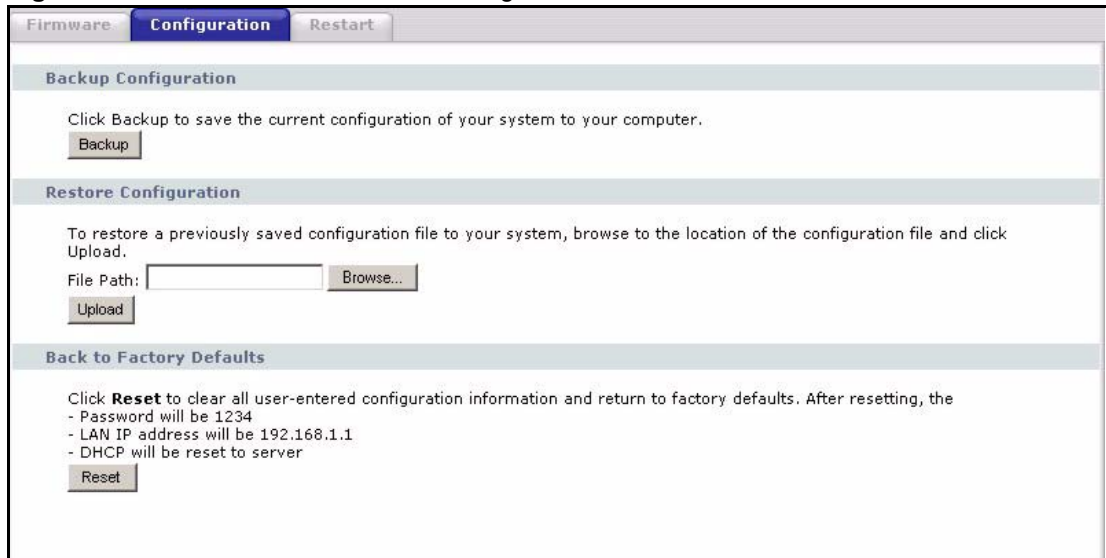

Each field is described in the following table.

**Table 128** Maintenance > Tools > Configuration

LABEL	DESCRIPTION
Backup Configuration	
Backup	Click this to save the ZyXEL Device's current configuration to a file on your computer. Once your device is configured and functioning properly, it is highly recommended that you back up your configuration file before making configuration changes. The backup configuration file is useful if you need to return to your previous settings.
Restore Configuration	

**Table 128** Maintenance > Tools > Configuration

LABEL	DESCRIPTION
File Path	Enter the location of the file you want to upload, or click <b>Browse...</b> to find it.
Browse	Click this to find the file you want to upload.
Upload	Click this to restore the selected configuration file. See <a href="#">Section 24.2.4 on page 276</a> for more information about this.  <b>Note: Do not turn off the device while configuration file upload is in progress.</b>
Back to Factory Defaults	
Reset	Click this to clear all user-entered configuration information and return the ZyXEL Device to its factory defaults. There is no warning screen.

## 24.2.4 Restore Configuration Screens



**Do not turn off the device while configuration file upload is in progress.**

When the ZyXEL Device has finished restoring the selected configuration file, the following screen appears.

**Figure 187** Configuration Upload Successful

The device now automatically restarts. This causes a temporary network disconnect. In some operating systems, you may see the following icon on your desktop.

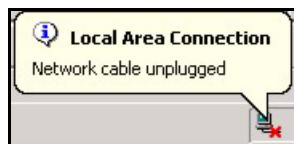
**Figure 188** Network Temporarily Disconnected

If the ZyXEL Device's IP address is different in the configuration file you selected, you may need to change the IP address of your computer to be in the same subnet as that of the default management IP address (192.168.5.1). See your Quick Start Guide or the appendices for details on how to set up your computer's IP address.

You might have to open a new browser to log in again.

If the upload was not successful, a **Configuration Upload Error** screen appears.

**Figure 189** Configuration Upload Error



Click **Return** to go back to the [Configuration Screen](#).

## 24.2.5 Restart Screen

Use this screen to reboot the ZyXEL Device without turning the power off. To access this screen, click **Maintenance > Tools > Restart**.

**Figure 190** Maintenance > Tools > Restart

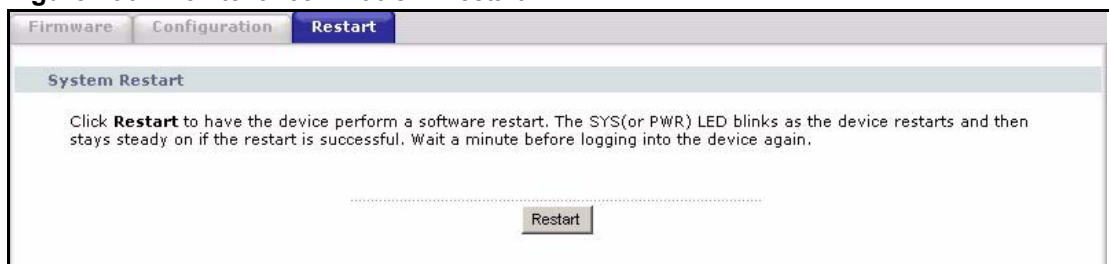

This does not affect the ZyXEL Device's configuration. When you click **Restart**, the following screen appears.

**Figure 191** Maintenance > Tools > Restart > In Progress



Wait one minute for the device to finish restarting. Then, you can log in again.



# Troubleshooting

This chapter offers some suggestions to solve problems you might encounter. The potential problems are divided into the following categories.

- [Power, Hardware Connections, and LEDs](#)
- [ZyXEL Device Access and Login](#)
- [Internet Access](#)
- [Phone Calls and VoIP](#)
- [Problems With Multiple SIP Accounts](#)

## 25.1 Power, Hardware Connections, and LEDs



---

**The ZyXEL Device does not turn on. None of the LEDs turn on.**

---

- 1 Make sure you are using the power adaptor or cord included with the ZyXEL Device.
- 2 Make sure the power adaptor or cord is connected to the ZyXEL Device and plugged in to an appropriate power source. Make sure the power source is turned on.
- 3 Turn the ZyXEL Device off and on.
- 4 Disconnect and re-connect the power adaptor or cord to the ZyXEL Device.
- 5 If the problem continues, contact the vendor.



---

**One of the LEDs does not behave as expected.**

---

- 1 Make sure you understand the normal behavior of the LED. See [Section 1.4 on page 36](#).
- 2 Check the hardware connections. See the Quick Start Guide.
- 3 Inspect your cables for damage. Contact the vendor to replace any damaged cables.
- 4 Disconnect and re-connect the power adaptor to the ZyXEL Device.
- 5 If the problem continues, contact the vendor.

## 25.2 ZyXEL Device Access and Login



---

### I forgot the IP address for the ZyXEL Device.

---

- 1 The default IP address is **192.168.1.1**.
- 2 If you changed the IP address and have forgotten it, you might get the IP address of the ZyXEL Device by looking up the IP address of the default gateway for your computer. To do this in most Windows computers, click **Start > Run**, enter **cmd**, and then enter **ipconfig**. The IP address of the **Default Gateway** might be the IP address of the ZyXEL Device (it depends on the network), so enter this IP address in your Internet browser.
- 3 If this does not work, you have to reset the device to its factory defaults. See [Section 2.3 on page 41](#).



---

### I forgot the password.

---

- 1 The default password is **1234**.
- 2 If this does not work, you have to reset the device to its factory defaults. See [Section 2.3 on page 41](#).



---

### I cannot see or access the Login screen in the web configurator.

---

- 1 Make sure you are using the correct IP address.
  - The default IP address is [192.168.1.1](#).
  - If you changed the IP address, use the new IP address.
  - If you changed the IP address and have forgotten it, see the troubleshooting suggestions for [I forgot the IP address for the ZyXEL Device](#).
- 2 Check the hardware connections, and make sure the LEDs are behaving as expected. See the Quick Start Guide and [Section 1.4 on page 36](#).
- 3 Make sure your Internet browser does not block pop-up windows and has JavaScripts and Java enabled. See [Appendix B on page 293](#).
- 4 If you disabled **Any IP** ([Section 7.1.7 on page 108](#)), make sure your computer is in the same subnet as the ZyXEL Device. (If you know that there are routers between your computer and the ZyXEL Device, skip this step.)
  - If there is a DHCP server on your network, make sure your computer is using a dynamic IP address. See [Appendix D on page 307](#). Your ZyXEL Device is a DHCP server by default.
  - If there is no DHCP server on your network, make sure your computer's IP address is in the same subnet as the ZyXEL Device. See [Appendix D on page 307](#).



- 5 Reset the device to its factory defaults, and try to access the ZyXEL Device with the default IP address. See [Section 2.3 on page 41](#).
- 6 If the problem continues, contact the network administrator or vendor, or try one of the advanced suggestions.

#### Advanced Suggestions

- If your computer is connected to the **WAN** port or is connected wirelessly, use a computer that is connected to a **LAN/ETHERNET** port.



---

#### I can see the Login screen, but I cannot log in to the ZyXEL Device.

---

- 1 Make sure you have entered the user name and password correctly. The default user name is **admin**, and the default password is **1234**. These fields are case-sensitive, so make sure [Caps Lock] is not on.
- 2 Disconnect and re-connect the power adaptor or cord to the ZyXEL Device.
- 3 If this does not work, you have to reset the device to its factory defaults. See [Section 2.3 on page 41](#).

## 25.3 Internet Access



---

#### I cannot access the Internet.

---

- 1 Check the hardware connections, and make sure the LEDs are behaving as expected. See the Quick Start Guide and [Section 1.4 on page 36](#).
- 2 Make sure you entered your ISP account information correctly in the wizard. These fields are case-sensitive, so make sure [Caps Lock] is not on.
- 3 If you are trying to access the Internet wirelessly, make sure the wireless settings in the wireless client are the same as the settings in the AP.
- 4 Disconnect all the cables from your device, and follow the directions in the Quick Start Guide again.
- 5 If the problem continues, contact your ISP.



---

#### I cannot access the Internet anymore. I had access to the Internet (with the ZyXEL Device), but my Internet connection is not available anymore.

---

- 1 Check the hardware connections, and make sure the LEDs are behaving as expected. See the Quick Start Guide and [Section 1.4 on page 36](#).
- 2 Disconnect and re-connect the power adaptor to the ZyXEL Device.
- 3 Turn the ZyXEL Device off and on.

- 4 If the problem continues, contact your ISP.



---

### The Internet connection is slow or intermittent.

---

- 1 There might be a lot of traffic on the network. Try closing some programs that use the Internet, especially peer-to-peer applications.
- 2 Check the signal strength. If the signal strength is low, try moving the ZyXEL Device closer to the AP if possible, and look around to see if there are any devices that might be interfering with the wireless network (for example, microwaves, other wireless networks, and so on).
- 3 Disconnect and re-connect the power adaptor to the ZyXEL Device.
- 4 If the problem continues, contact the network administrator or vendor, or try one of the advanced suggestions.

#### Advanced Suggestions

- Check the settings for bandwidth management. If it is disabled, you might consider activating it. If it is enabled, you might consider changing the allocations.
- Check the settings for QoS. If it is disabled, you might consider activating it. If it is enabled, you might consider raising or lowering the priority for some applications.

## 25.4 Phone Calls and VoIP



---

### I cannot make telephone calls using the telephone that is connected to the ZyXEL Device.

---

- 1 Check the telephone connections and telephone wire.
- 2 Make sure you have the **VoIP > SIP Settings** screen properly configured. See [Section 9.3.1 on page 134](#). The **PHONE 1** or **PHONE 2** LED should be on when the SIP line is properly registered.
- 3 If you are trying to make a PSTN call, make sure you are using the phone connected to the **PHONE 1** port.

## 25.5 Problems With Multiple SIP Accounts

You can set up two SIP accounts on your ZyXEL Device and your ZyXEL Device is equipped with two phone ports. By default your ZyXEL Device uses SIP account 1 with both phone ports for outgoing calls, and it uses SIP accounts 1 and 2 for incoming calls. With this setting, you always use SIP account 1 for your outgoing calls and you cannot distinguish which SIP account the calls are coming in through. If you want to control the use of different dialing plans for accounting purposes or other reasons, you need to configure your phone ports in order to control which SIP account you are using when placing or receiving calls.

## 25.5.1 Outgoing Calls

The following figure represents the default behavior of your ZyXEL Device when two SIP accounts are configured and you are using two phones. When you place a call from phone 1 or phone 2, the ZyXEL Device will use SIP account 1.

**Figure 192** Outgoing Calls: Default

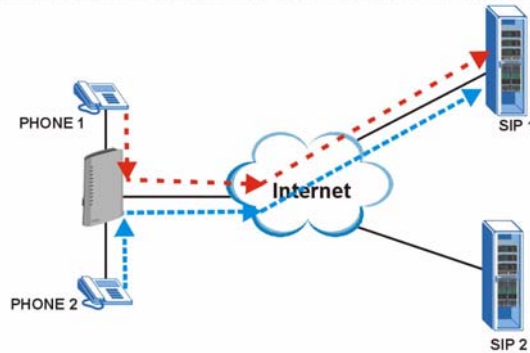

In the next example, phone port 1 is configured to use SIP account 1 and phone port 2 is configured to use SIP account 2. In this case, every time you place a call through phone port 1, you are using your SIP account 1. Similarly, every time you place a call through phone port 2, you are using your SIP account 2. To apply these configuration changes you need to configure the **Analog Phone** screen. See [Section 10.2 on page 144](#).

**Figure 193** Outgoing Calls: Individual Configuration

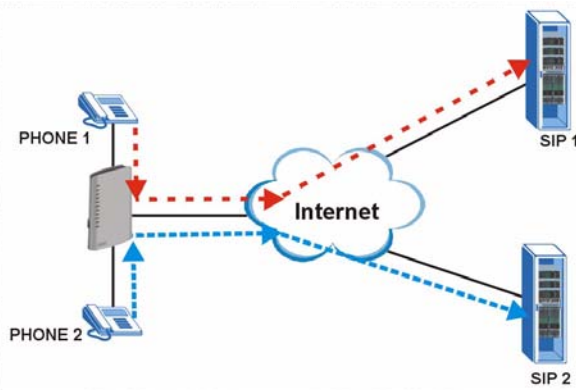

## 25.5.2 Incoming Calls

The following example shows the default behavior of your ZyXEL Device for incoming calls when two SIP accounts are configured and you are using two phones. When a call comes in from your SIP account 1, the phones connected to both phone port 1 and phone port 2 ring. Similarly, when a call comes in from your SIP account 2, the phones connected to both phone port 1 and phone port 2 ring. In either case you are not sure which SIP account the call is coming from.

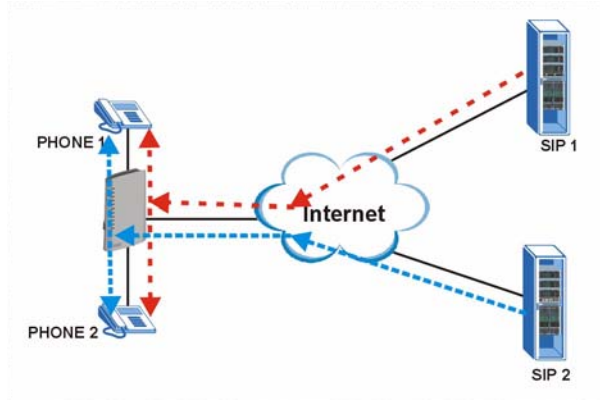
**Figure 194** Incoming Calls: Default

In the next example, phone port 1 is configured to use SIP account 1 and phone port 2 is configured to use SIP account 2 for incoming calls. In this case, every time you receive a call from your SIP account 1, the phone connected to phone port 1 rings. Similarly, every time you receive a call from your SIP account 2, the phone connected to phone port 2 rings. To apply these configuration changes you need to configure the **Analog Phone** screen. See [Section 10.2 on page 144](#).

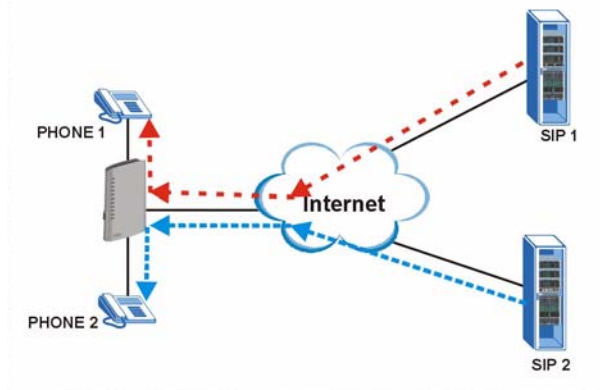
**Figure 195** Incoming Calls: Individual Configuration

---

# PART VII

## Appendices and Index

---

Product Specifications (287)  
IP Addresses and Subnetting (299)  
SIP Passthrough (321)  
Internal SPTGEN (323)  
Services (339)  
Legal Information (343)  
Customer Support (347)  
Index (351)



# Product Specifications

See also the introduction chapter for a general overview of the key features.

## Specification Tables

**Table 129** Device Specifications

Default IP Address	192.168.1.1
Default Management Subnet Mask	255.255.255.0 (24 bits)
Default Password	1234
Dimensions	215.5mm (High) x 147.5mm (Wide) x 56.5mm (Deep) x
Weight	464 g
WAN Port	One RJ-45, 10/100Mbps Half / Full Auto-negotiation, Auto-crossover Ethernet port
Ethernet Ports	Four RJ-45, 10/100Mbps Half / Full Auto-negotiation, Auto-crossover Ethernet ports
Phone Ports	Two FXS (Foreign Exchange Station) POTS ports
Line Port (P-2302HWUDL-P1 only)	One FXO (Foreign Exchange Office) lifeline port
USB Ports	Two USB v2.0 ports for file sharing and print server setup.
File Systems Supported for File Sharing	FAT (File Allocation Table) and FAT32 (derivative of FAT with more efficient space allocation)
Operation Temperature	0° C ~ 40° C
Storage Temperature	-30° ~ 60° C
Operation Humidity	20% ~ 95% RH
Storage Humidity	20% ~ 95% RH

**Table 130** Firmware Features

FEATURE	DESCRIPTION
Device Management	Use the web configurator to easily configure the rich range of features on the ZyXEL Device.
Firmware Upgrade	Download new firmware (when available) from the ZyXEL web site and use the web configurator, an FTP or a TFTP tool to put it on the ZyXEL Device.  <b>Note: Only upload firmware for your specific model!</b>
VoIP	The ZyXEL Device serves as a VoIP gateway allowing you to make calls via a SIP server or via an IP address of a peer device. It also supports VoIP trunking allowing you to save on long distance calls by creating links between VoIP and PSTN network.
DECT GAP Base Station	The ZyXEL Device has a built-in DECT GAP profile base station which allows you to register up to 6 DECT GAP phones with it and use them to make internal, VoIP or PSTN calls.
USB File/Print Server	The ZyXEL Device allows you to plug in a USB file storage device or a USB printer making them available to all the users on your local area network.
IEEE 802.11g Wireless LAN	The ZyXEL Device can serve as an IEEE 802.11g wireless access point. Expand your network by allowing IEEE 802.11g and IEEE 802.11b devices to connect to your network.
Wireless Security	The ZyXEL Device supports WEP encryption for basic security as well as WPA and WPA2 security standards. You can also use OTIST to easily configure your wireless security on both your ZyXEL Device and compatible wireless clients.
MAC Address Filter	Allow or deny access to your wired or wireless network based on the MAC addresses of the computers communicating with your network.
Any IP	The Any IP feature allows a computer to access the Internet and the ZyXEL Device without changing the network settings (such as IP address and subnet mask) of the computer, when the IP addresses of the computer and the ZyXEL Device are not in the same subnet.
Configuration Backup & Restoration	Make a copy of the ZyXEL Device's configuration and put it back on the ZyXEL Device later if you decide you want to revert back to an earlier configuration.
Network Address Translation (NAT)	Each computer on your network must have its own unique IP address. Use NAT to convert a single public IP address to multiple private IP addresses for the computers on your network.
Port Forwarding	If you have a server (mail or web server for example) on your network, then use this feature to let people access it from the Internet.
DHCP (Dynamic Host Configuration Protocol)	Use this feature to have the ZyXEL Device assign IP addresses, an IP default gateway and DNS servers to computers on your network.
Dynamic DNS Support	With Dynamic DNS (Domain Name System) support, you can use a fixed URL, www.zyxel.com for example, with a dynamic IP address. You must register for this service with a Dynamic DNS service provider.
IP Multicast	IP Multicast is used to send traffic to a specific group of computers. The ZyXEL Device supports versions 1 and 2 of IGMP (Internet Group Management Protocol) used to join multicast groups (see RFC 2236).
IP Alias	IP Alias allows you to subdivide a physical network into logical networks over the same Ethernet interface with the ZyXEL Device itself as the gateway for each subnet.



**Table 130** Firmware Features

FEATURE	DESCRIPTION
Time and Date	Get the current time and date from an external server when you turn on your ZyXEL Device. You can also set the time manually. These dates and times are then used in logs.
Logging and Tracing	Use packet tracing and logs for troubleshooting. You can send logs from the ZyXEL Device to an external UNIX syslog server.
PPPoE	PPPoE mimics a dial-up over Ethernet Internet access connection.
Universal Plug and Play (UPnP)	The ZyXEL Device can communicate with other UPnP enabled devices in a network.

**Table 131** Feature Specifications

Voice Functions	<p>SIP (RFC 3261) version 2</p> <p>SDP (RFC 2327)</p> <p>RTP (RFC 1889)</p> <p>RTCP (RFC 1890)</p> <p>G.168 Echo Cancellation</p> <p>VAD (Voice Activity Detection)</p> <p>Silence Suppression</p> <p>CNG (Comfort Noise Generation)</p> <p>QoS Supports TOS and Diffserv Tagging</p> <p>Compression: G.711 (PCM), G.729 (ADPCM)</p> <p>Loop Start Signaling Support</p> <p>Modem and Fax Tone Detection and Pass Through</p> <p>DTMF Detection</p> <p>Point to Point Calling (Direct IP to IP Calling)</p> <p>Speed Dial Phonebook</p> <p>Lifeline Support (P-2302HWUDL-P1 only)</p> <p>Support NAT Traversal / RFC 3489- IETF Simple Traversal of UDP Through NAT (STUN)</p> <p>Caller ID</p> <p>Dialing Type: Tone, Pulse (Auto detection)</p> <p>Tip/ring polarity reversal</p> <p>VoIP Trunking</p>
DECT Base Station	<p>DECT GAP profile support</p> <p>Up to 6 DECT GAP phones can be registered with the ZyXEL Device.</p> <p>4 DECT GAP phones can be active at any one time.</p> <p>Range varies depending on your location and handset strength.</p> <p>DECT GAP phone and base station typically have a range of: 50 meters indoors and 250 meters outdoors</p>
Wireless	<p>WEP key authentication</p> <p>WPA-PSK security</p> <p>WPA/WPA2 security</p> <p>IEEE 802.11g (compatible with IEEE 802.11b)</p> <p>MAC address filtering</p> <p>OTIST (One Touch Intelligent Security Technology)</p>
Protocol Support	<p>PPP over Ethernet (RFC 2516)</p> <p>Transparent bridging for unsupported network layer protocols.</p> <p>DHCP Client</p>

**Table 131** Feature Specifications (continued)

Management	Embedded Web Configurator CLI (Command Line Interpreter) Remote Management via Telnet or Web FTP/TFTP for firmware downloading, configuration backup and restoration Syslog Built-in Diagnostic Tools for FLASH memory, RAM and LAN port
Firewall	Stateful Packet Inspection. Prevent Denial of Service attacks such as Ping of Death, SYN Flood, LAND, Smurf etc. Real time E-mail alerts. Reports and logs.
Content Filtering	Service blocking. Web page blocking by URL keyword.
NAT/SUA	Port Forwarding 2048 NAT sessions Multimedia application. PPTP under NAT/SUA. IPSec passthrough SIP ALG passthrough.
Static Routes	8 IP

## Power Adaptor Specifications

**Table 132** ZyXEL Device Power Adaptor Specifications

<b>NORTH AMERICAN PLUG STANDARDS</b>	
AC Power Adapter Model	AA-161A
Input Power	AC 120Volts/60Hz/26W max
Output Power	AC 16Volts/1.0A
Power Consumption	15 Watt Max.
Safety Standards	UL, CUL (ANSI/UL 1310,CAN/CSA-C22.2 No. 223)
<b>EUROPEAN PLUG STANDARDS</b>	
AC Power Adapter Model	AA-161ABN
Input Power	AC 230Volts/50Hz/140mA
Output Power	AC 16Volts/1.0A
Power Consumption	15 Watt Max.
Safety Standards	ITS-GS, CE (EN 60950-1)
<b>UNITED KINGDOM PLUG STANDARDS</b>	
AC Power Adapter Model	AA-161AD
Input Power	AC 240Volts/50Hz/140mA
Output Power	AC 16Volts/1.0A

**Table 132** ZyXEL Device Power Adaptor Specifications (continued)

Power Consumption	15 Watt Max.
Safety Standards	ITS-GS (BS EN 60950-1)
<b>AUSTRALIA AND NEW ZEALAND PLUG STANDARDS</b>	
AC Power Adapter Model	AA-161AE
Input Power	AC 240Volts/50Hz/140mA
Output Power	AC 16Volts/1.0A
Power Consumption	15 Watt Max.
Safety Standards	DOFT (AS/NZS 60950, AS/NZS 3112:1-2)



# Pop-Up Windows, Java and JavaScript Permissions

This appendix show you how to change your browser settings to ensure that the web configurator works properly

## 25.6 Pop-up Windows, JavaScripts and Java Permissions

In order to use the web configurator you need to allow:

- Web browser pop-up windows from your device.
- JavaScripts (enabled by default).
- Java permissions (enabled by default).



---

**Internet Explorer 6 screens are used here. Screens for other Internet Explorer versions may vary.**

---

### 25.6.1 Internet Explorer Pop-up Blockers

You may have to disable pop-up blocking to log into your device.

Either disable pop-up blocking (enabled by default in Windows XP SP (Service Pack) 2) or allow pop-up blocking and create an exception for your device's IP address.

#### 25.6.1.1 Disable pop-up Blockers

- 1 In Internet Explorer, select **Tools, Pop-up Blocker** and then select **Turn Off Pop-up Blocker**.

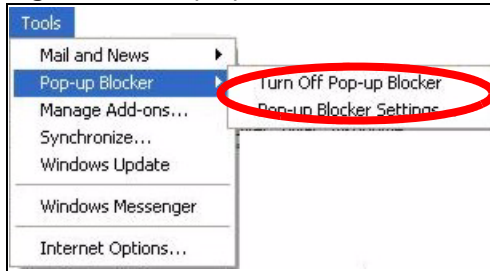
**Figure 196** Pop-up Blocker

You can also check if pop-up blocking is disabled in the **Pop-up Blocker** section in the **Privacy** tab.

- 1 In Internet Explorer, select **Tools, Internet Options, Privacy**.
- 2 Clear the **Block pop-ups** check box in the **Pop-up Blocker** section of the screen. This disables any web pop-up blockers you may have enabled.

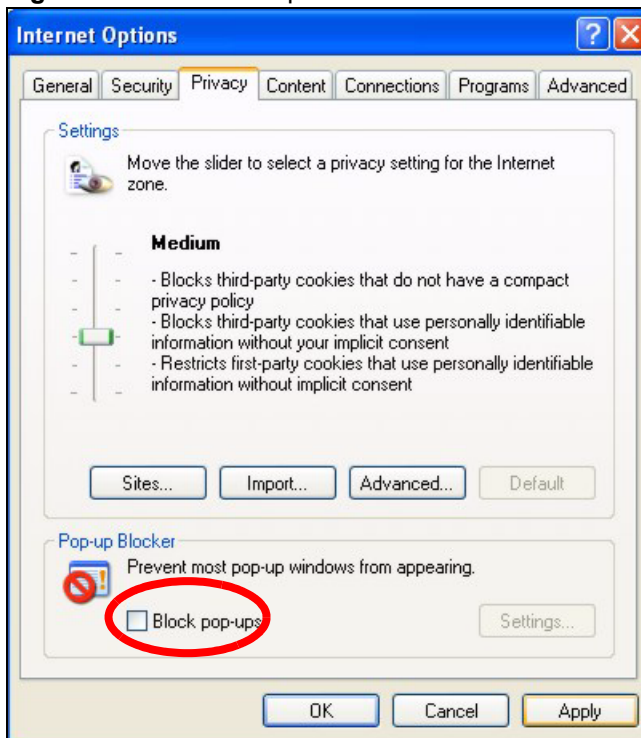
**Figure 197** Internet Options

- 3 Click **Apply** to save this setting.

### 25.6.1.2 Enable pop-up Blockers with Exceptions

Alternatively, if you only want to allow pop-up windows from your device, see the following steps.

- 1 In Internet Explorer, select **Tools, Internet Options** and then the **Privacy** tab.
- 2 Select **Settings...** to open the **Pop-up Blocker Settings** screen.

Figure 198 Internet Options

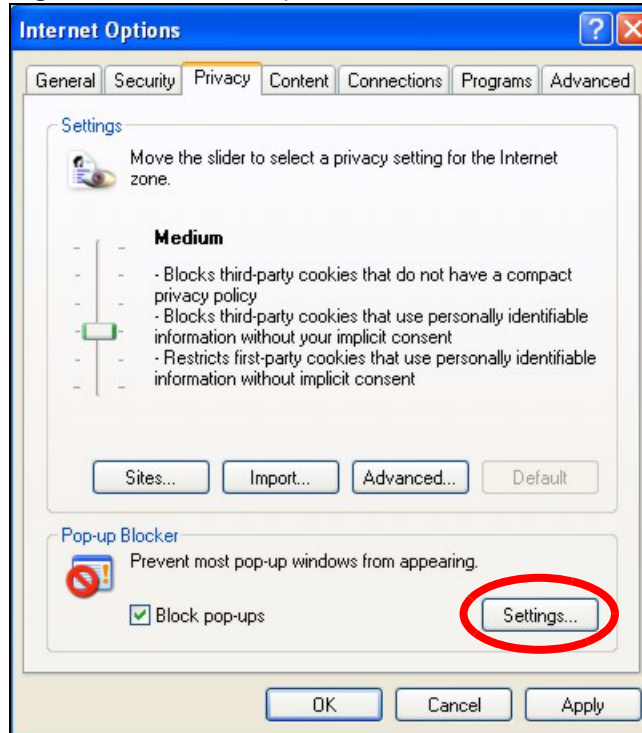

- 3 Type the IP address of your device (the web page that you do not want to have blocked) with the prefix "http://". For example, `http://192.168.1.1`.
- 4 Click **Add** to move the IP address to the list of **Allowed sites**.

Figure 199 Pop-up Blocker Settings

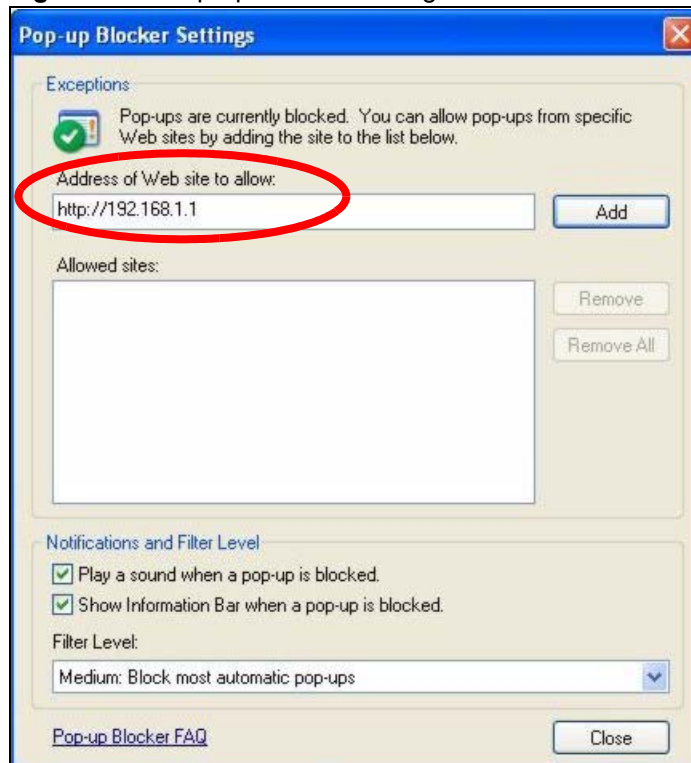

- 5 Click **Close** to return to the **Privacy** screen.
- 6 Click **Apply** to save this setting.

## 25.6.2 JavaScripts

If pages of the web configurator do not display properly in Internet Explorer, check that JavaScripts are allowed.

- 1 In Internet Explorer, click **Tools, Internet Options** and then the **Security** tab.

**Figure 200** Internet Options

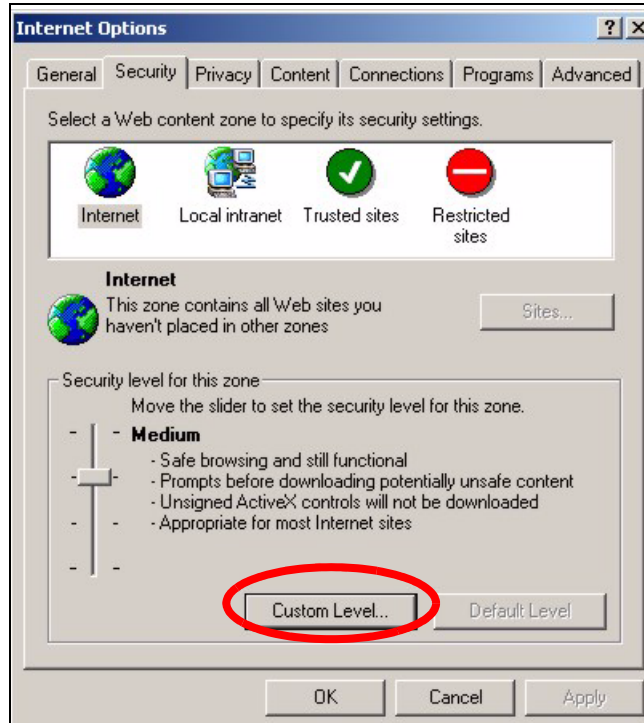

- 2 Click the **Custom Level...** button.
- 3 Scroll down to **Scripting**.
- 4 Under **Active scripting** make sure that **Enable** is selected (the default).
- 5 Under **Scripting of Java applets** make sure that **Enable** is selected (the default).
- 6 Click **OK** to close the window.

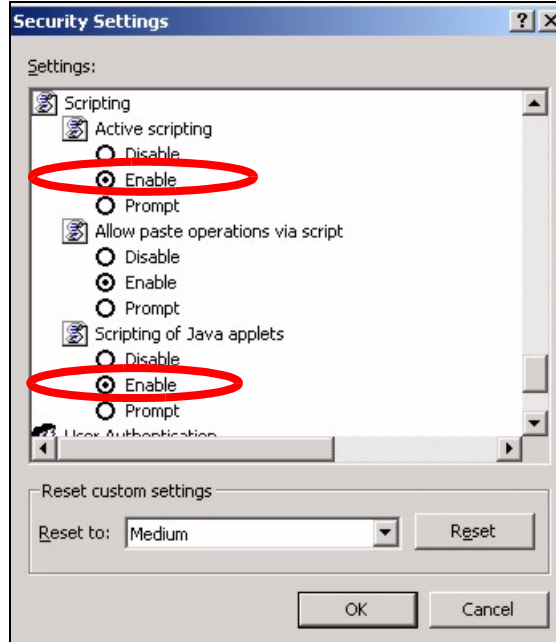

**Figure 201** Security Settings - Java Scripting

### 25.6.3 Java Permissions

- 1 From Internet Explorer, click **Tools, Internet Options** and then the **Security** tab.
- 2 Click the **Custom Level...** button.
- 3 Scroll down to **Microsoft VM**.
- 4 Under **Java permissions** make sure that a safety level is selected.
- 5 Click **OK** to close the window.

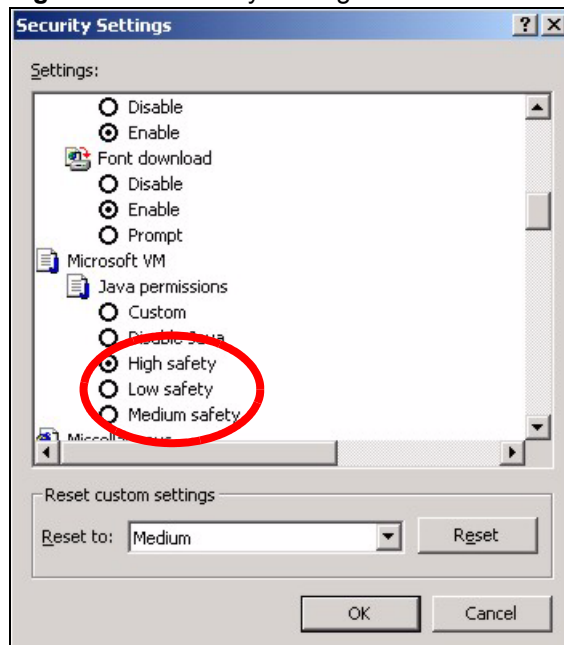
**Figure 202** Security Settings - Java

### 25.6.3.1 JAVA (Sun)

- 1 From Internet Explorer, click **Tools, Internet Options** and then the **Advanced** tab.
- 2 make sure that **Use Java 2 for <applet>** under **Java (Sun)** is selected.
- 3 Click **OK** to close the window.

Figure 203 Java (Sun)

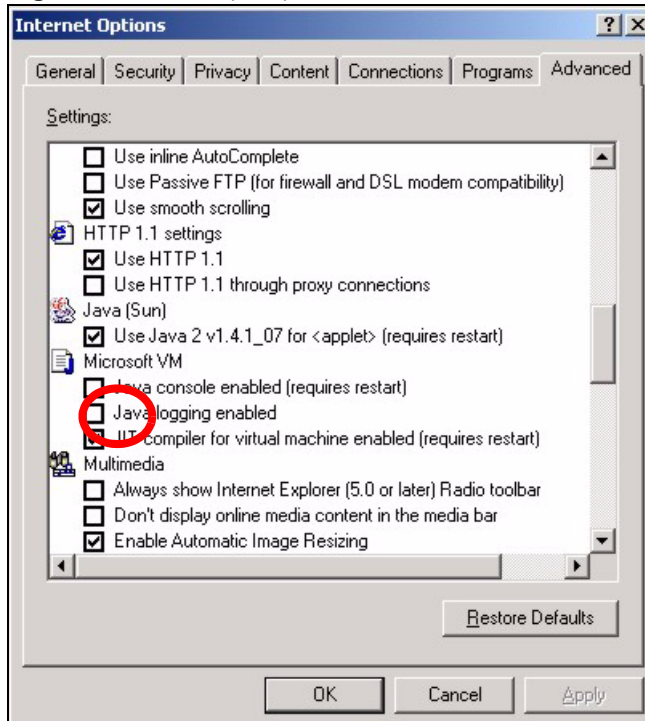

# IP Addresses and Subnetting

This appendix introduces IP addresses and subnet masks.

IP addresses identify individual devices on a network. Every networking device (including computers, servers, routers, printers, etc.) needs an IP address to communicate across the network. These networking devices are also known as hosts.

Subnet masks determine the maximum number of possible hosts on a network. You can also use subnet masks to divide one network into multiple sub-networks.

## Introduction to IP Addresses

One part of the IP address is the network number, and the other part is the host ID. In the same way that houses on a street share a common street name, the hosts on a network share a common network number. Similarly, as each house has its own house number, each host on the network has its own unique identifying number - the host ID. Routers use the network number to send packets to the correct network, while the host ID determines to which host on the network the packets are delivered.

## Structure

An IP address is made up of four parts, written in dotted decimal notation (for example, 192.168.1.1). Each of these four parts is known as an octet. An octet is an eight-digit binary number (for example 11000000, which is 192 in decimal notation).

Therefore, each octet has a possible range of 00000000 to 11111111 in binary, or 0 to 255 in decimal.

The following figure shows an example IP address in which the first three octets (192.168.1) are the network number, and the fourth octet (16) is the host ID.

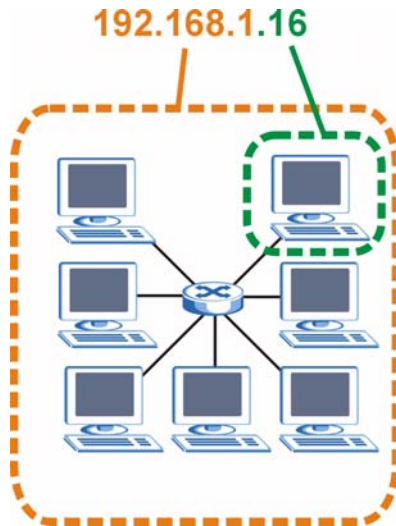
**Figure 204** Network Number and Host ID

How much of the IP address is the network number and how much is the host ID varies according to the subnet mask.

## Subnet Masks

A subnet mask is used to determine which bits are part of the network number, and which bits are part of the host ID (using a logical AND operation). The term “subnet” is short for “sub-network”.

A subnet mask has 32 bits. If a bit in the subnet mask is a “1” then the corresponding bit in the IP address is part of the network number. If a bit in the subnet mask is “0” then the corresponding bit in the IP address is part of the host ID.

The following example shows a subnet mask identifying the network number (in bold text) and host ID of an IP address (192.168.1.2 in decimal).

**Table 133**

	<b>1ST OCTET: (192)</b>	<b>2ND OCTET: (168)</b>	<b>3RD OCTET: (1)</b>	<b>4TH OCTET (2)</b>
IP Address (Binary)	11000000	10101000	00000001	00000010
Subnet Mask (Binary)	<b>11111111</b>	<b>11111111</b>	<b>11111111</b>	00000000
Network Number	<b>11000000</b>	<b>10101000</b>	<b>00000001</b>	
Host ID				00000010

By convention, subnet masks always consist of a continuous sequence of ones beginning from the leftmost bit of the mask, followed by a continuous sequence of zeros, for a total number of 32 bits.

Subnet masks can be referred to by the size of the network number part (the bits with a “1” value). For example, an “8-bit mask” means that the first 8 bits of the mask are ones and the remaining 24 bits are zeroes.

Subnet masks are expressed in dotted decimal notation just like IP addresses. The following examples show the binary and decimal notation for 8-bit, 16-bit, 24-bit and 29-bit subnet masks.

**Table 134** Subnet Masks

	BINARY				DECIMAL
	1ST OCTET	2ND OCTET	3RD OCTET	4TH OCTET	
8-bit mask	11111111	00000000	00000000	00000000	255.0.0.0
16-bit mask	11111111	11111111	00000000	00000000	255.255.0.0
24-bit mask	11111111	11111111	11111111	00000000	255.255.255.0
29-bit mask	11111111	11111111	11111111	11111000	255.255.255.248

## Network Size

The size of the network number determines the maximum number of possible hosts you can have on your network. The larger the number of network number bits, the smaller the number of remaining host ID bits.

An IP address with host IDs of all zeros is the IP address of the network (192.168.1.0 with a 24-bit subnet mask, for example). An IP address with host IDs of all ones is the broadcast address for that network (192.168.1.255 with a 24-bit subnet mask, for example).

As these two IP addresses cannot be used for individual hosts, calculate the maximum number of possible hosts in a network as follows:

**Table 135** Maximum Host Numbers

SUBNET MASK		HOST ID SIZE		MAXIMUM NUMBER OF HOSTS
8 bits	255.0.0.0	24 bits	$2^{24} - 2$	16777214
16 bits	255.255.0.0	16 bits	$2^{16} - 2$	65534
24 bits	255.255.255.0	8 bits	$2^8 - 2$	254
29 bits	255.255.255.248	3 bits	$2^3 - 2$	6

## Notation

Since the mask is always a continuous number of ones beginning from the left, followed by a continuous number of zeros for the remainder of the 32 bit mask, you can simply specify the number of ones instead of writing the value of each octet. This is usually specified by writing a “/” followed by the number of bits in the mask after the address.

For example, 192.1.1.0 /25 is equivalent to saying 192.1.1.0 with subnet mask 255.255.255.128.

The following table shows some possible subnet masks using both notations.

**Table 136** Alternative Subnet Mask Notation

SUBNET MASK	ALTERNATIVE NOTATION	LAST OCTET (BINARY)	LAST OCTET (DECIMAL)
255.255.255.0	/24	0000 0000	0
255.255.255.128	/25	1000 0000	128

**Table 136** Alternative Subnet Mask Notation (continued)

SUBNET MASK	ALTERNATIVE NOTATION	LAST OCTET (BINARY)	LAST OCTET (DECIMAL)
255.255.255.192	/26	1100 0000	192
255.255.255.224	/27	1110 0000	224
255.255.255.240	/28	1111 0000	240
255.255.255.248	/29	1111 1000	248
255.255.255.252	/30	1111 1100	252

## Subnetting

You can use subnetting to divide one network into multiple sub-networks. In the following example a network administrator creates two sub-networks to isolate a group of servers from the rest of the company network for security reasons.

In this example, the company network address is 192.168.1.0. The first three octets of the address (192.168.1) are the network number, and the remaining octet is the host ID, allowing a maximum of  $2^8 - 2$  or 254 possible hosts.

The following figure shows the company network before subnetting.

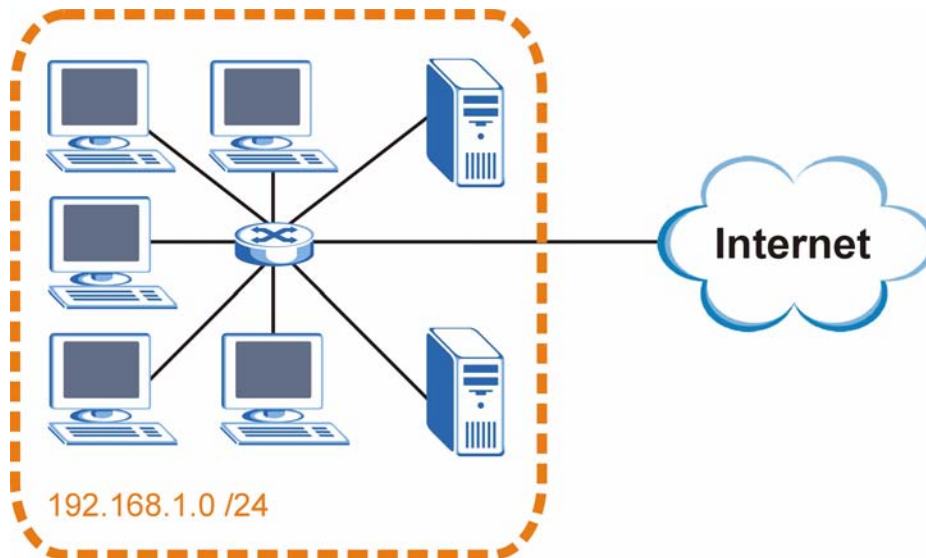
**Figure 205** Subnetting Example: Before Subnetting

You can “borrow” one of the host ID bits to divide the network 192.168.1.0 into two separate sub-networks. The subnet mask is now 25 bits (255.255.255.128 or /25).

The “borrowed” host ID bit can have a value of either 0 or 1, allowing two subnets; 192.168.1.0 /25 and 192.168.1.128 /25.

The following figure shows the company network after subnetting. There are now two sub-networks, **A** and **B**.

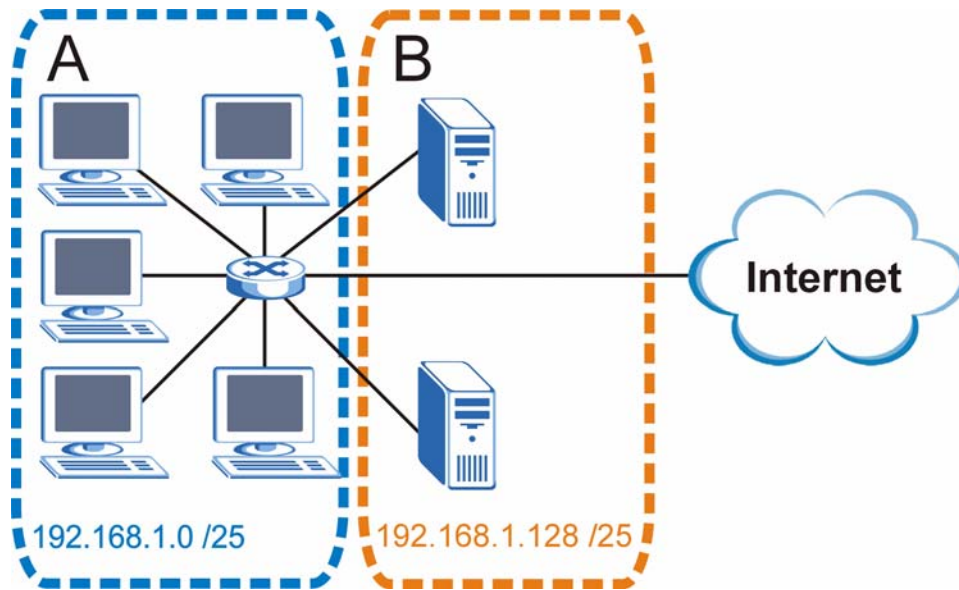
**Figure 206** Subnetting Example: After Subnetting

In a 25-bit subnet the host ID has 7 bits, so each sub-network has a maximum of  $2^7 - 2$  or 126 possible hosts (a host ID of all zeroes is the subnet's address itself, all ones is the subnet's broadcast address).

192.168.1.0 with mask 255.255.255.128 is subnet **A** itself, and 192.168.1.127 with mask 255.255.255.128 is its broadcast address. Therefore, the lowest IP address that can be assigned to an actual host for subnet **A** is 192.168.1.1 and the highest is 192.168.1.126.

Similarly, the host ID range for subnet **B** is 192.168.1.129 to 192.168.1.254.

## Example: Four Subnets

The previous example illustrated using a 25-bit subnet mask to divide a 24-bit address into two subnets. Similarly, to divide a 24-bit address into four subnets, you need to “borrow” two host ID bits to give four possible combinations (00, 01, 10 and 11). The subnet mask is 26 bits (11111111.11111111.11111111.11000000) or 255.255.255.192.

Each subnet contains 6 host ID bits, giving  $2^6 - 2$  or 62 hosts for each subnet (a host ID of all zeroes is the subnet itself, all ones is the subnet's broadcast address).

**Table 137** Subnet 1

IP/SUBNET MASK	NETWORK NUMBER	LAST OCTET BIT VALUE
IP Address (Decimal)	192.168.1.	0
IP Address (Binary)	11000000.10101000.00000001.	00000000
Subnet Mask (Binary)	11111111.11111111.11111111.	11000000
Subnet Address: 192.168.1.0	Lowest Host ID: 192.168.1.1	
Broadcast Address: 192.168.1.63	Highest Host ID: 192.168.1.62	

**Table 138** Subnet 2

IP/SUBNET MASK	NETWORK NUMBER	LAST OCTET BIT VALUE
IP Address	192.168.1.	64
IP Address (Binary)	11000000.10101000.00000001.	01000000
Subnet Mask (Binary)	11111111.11111111.11111111.	11000000
Subnet Address: 192.168.1.64	Lowest Host ID: 192.168.1.65	
Broadcast Address: 192.168.1.127	Highest Host ID: 192.168.1.126	

**Table 139** Subnet 3

IP/SUBNET MASK	NETWORK NUMBER	LAST OCTET BIT VALUE
IP Address	192.168.1.	128
IP Address (Binary)	11000000.10101000.00000001.	10000000
Subnet Mask (Binary)	11111111.11111111.11111111.	11000000
Subnet Address: 192.168.1.128	Lowest Host ID: 192.168.1.129	
Broadcast Address: 192.168.1.191	Highest Host ID: 192.168.1.190	

**Table 140** Subnet 4

IP/SUBNET MASK	NETWORK NUMBER	LAST OCTET BIT VALUE
IP Address	192.168.1.	192
IP Address (Binary)	11000000.10101000.00000001.	11000000
Subnet Mask (Binary)	11111111.11111111.11111111.	11000000
Subnet Address: 192.168.1.192	Lowest Host ID: 192.168.1.193	
Broadcast Address: 192.168.1.255	Highest Host ID: 192.168.1.254	

## Example: Eight Subnets

Similarly, use a 27-bit mask to create eight subnets (000, 001, 010, 011, 100, 101, 110 and 111).

The following table shows IP address last octet values for each subnet.

**Table 141** Eight Subnets

SUBNET	SUBNET ADDRESS	FIRST ADDRESS	LAST ADDRESS	BROADCAST ADDRESS
1	0	1	30	31
2	32	33	62	63
3	64	65	94	95
4	96	97	126	127



**Table 141** Eight Subnets (continued)

SUBNET	SUBNET ADDRESS	FIRST ADDRESS	LAST ADDRESS	BROADCAST ADDRESS
5	128	129	158	159
6	160	161	190	191
7	192	193	222	223
8	224	225	254	255

## Subnet Planning

The following table is a summary for subnet planning on a network with a 24-bit network number.

**Table 142** 24-bit Network Number Subnet Planning

NO. "BORROWED" HOST BITS	SUBNET MASK	NO. SUBNETS	NO. HOSTS PER SUBNET
1	255.255.255.128 (/25)	2	126
2	255.255.255.192 (/26)	4	62
3	255.255.255.224 (/27)	8	30
4	255.255.255.240 (/28)	16	14
5	255.255.255.248 (/29)	32	6
6	255.255.255.252 (/30)	64	2
7	255.255.255.254 (/31)	128	1

The following table is a summary for subnet planning on a network with a 16-bit network number.

**Table 143** 16-bit Network Number Subnet Planning

NO. "BORROWED" HOST BITS	SUBNET MASK	NO. SUBNETS	NO. HOSTS PER SUBNET
1	255.255.128.0 (/17)	2	32766
2	255.255.192.0 (/18)	4	16382
3	255.255.224.0 (/19)	8	8190
4	255.255.240.0 (/20)	16	4094
5	255.255.248.0 (/21)	32	2046
6	255.255.252.0 (/22)	64	1022
7	255.255.254.0 (/23)	128	510
8	255.255.255.0 (/24)	256	254
9	255.255.255.128 (/25)	512	126
10	255.255.255.192 (/26)	1024	62
11	255.255.255.224 (/27)	2048	30
12	255.255.255.240 (/28)	4096	14
13	255.255.255.248 (/29)	8192	6

**Table 143** 16-bit Network Number Subnet Planning (continued)

NO. "BORROWED" HOST BITS	SUBNET MASK	NO. SUBNETS	NO. HOSTS PER SUBNET
14	255.255.255.252 (/30)	16384	2
15	255.255.255.254 (/31)	32768	1

## Configuring IP Addresses

Where you obtain your network number depends on your particular situation. If the ISP or your network administrator assigns you a block of registered IP addresses, follow their instructions in selecting the IP addresses and the subnet mask.

If the ISP did not explicitly give you an IP network number, then most likely you have a single user account and the ISP will assign you a dynamic IP address when the connection is established. If this is the case, it is recommended that you select a network number from 192.168.0.0 to 192.168.255.0. The Internet Assigned Number Authority (IANA) reserved this block of addresses specifically for private use; please do not use any other number unless you are told otherwise. You must also enable Network Address Translation (NAT) on the ZyXEL Device.

Once you have decided on the network number, pick an IP address for your ZyXEL Device that is easy to remember (for instance, 192.168.1.1) but make sure that no other device on your network is using that IP address.

The subnet mask specifies the network number portion of an IP address. Your ZyXEL Device will compute the subnet mask automatically based on the IP address that you entered. You don't need to change the subnet mask computed by the ZyXEL Device unless you are instructed to do otherwise.

### Private IP Addresses

Every machine on the Internet must have a unique address. If your networks are isolated from the Internet (running only between two branch offices, for example) you can assign any IP addresses to the hosts without problems. However, the Internet Assigned Numbers Authority (IANA) has reserved the following three blocks of IP addresses specifically for private networks:

- 10.0.0.0 — 10.255.255.255
- 172.16.0.0 — 172.31.255.255
- 192.168.0.0 — 192.168.255.255

You can obtain your IP address from the IANA, from an ISP, or it can be assigned from a private network. If you belong to a small organization and your Internet access is through an ISP, the ISP can provide you with the Internet addresses for your local networks. On the other hand, if you are part of a much larger organization, you should consult your network administrator for the appropriate IP addresses.

Regardless of your particular situation, do not create an arbitrary IP address; always follow the guidelines above. For more information on address assignment, please refer to RFC 1597, *Address Allocation for Private Internets* and RFC 1466, *Guidelines for Management of IP Address Space*.

# Setting up Your Computer's IP Address

All computers must have a 10M or 100M Ethernet adapter card and TCP/IP installed.

Windows 95/98/Me/NT/2000/XP, Macintosh OS 7 and later operating systems and all versions of UNIX/LINUX include the software components you need to install and use TCP/IP on your computer. Windows 3.1 requires the purchase of a third-party TCP/IP application package.

TCP/IP should already be installed on computers using Windows NT/2000/XP, Macintosh OS 7 and later operating systems.

After the appropriate TCP/IP components are installed, configure the TCP/IP settings in order to “communicate” with your network.

## Windows 95/98/Me

Click **Start**, **Settings**, **Control Panel** and double-click the **Network** icon to open the **Network** window.

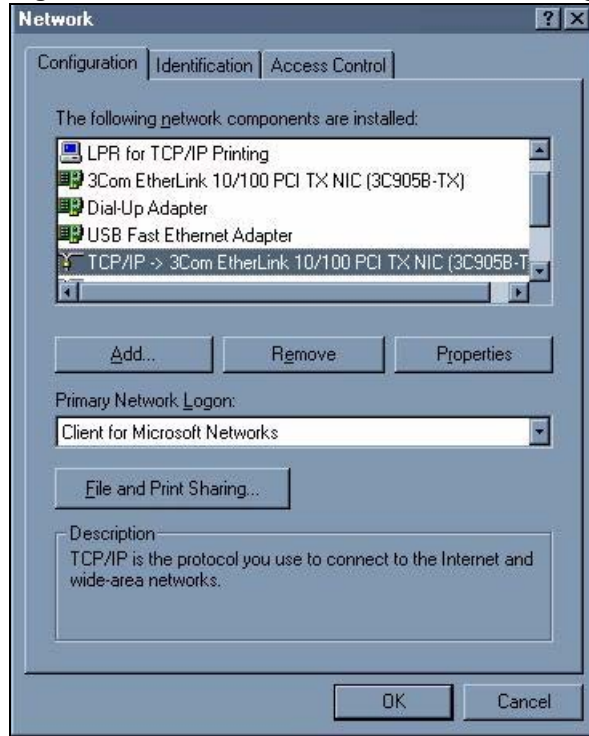
**Figure 207** Windows 95/98/Me: Network: Configuration

## Installing Components

The **Network** window **Configuration** tab displays a list of installed components. You need a network adapter, the TCP/IP protocol and Client for Microsoft Networks.

If you need the adapter:

- 1 In the **Network** window, click **Add**.
- 2 Select **Adapter** and then click **Add**.
- 3 Select the manufacturer and model of your network adapter and then click **OK**.

If you need TCP/IP:

- 1 In the **Network** window, click **Add**.
- 2 Select **Protocol** and then click **Add**.
- 3 Select **Microsoft** from the list of **manufacturers**.
- 4 Select **TCP/IP** from the list of network protocols and then click **OK**.

If you need Client for Microsoft Networks:

- 1 Click **Add**.
- 2 Select **Client** and then click **Add**.
- 3 Select **Microsoft** from the list of manufacturers.
- 4 Select **Client for Microsoft Networks** from the list of network clients and then click **OK**.
- 5 Restart your computer so the changes you made take effect.

## Configuring

- 1 In the **Network** window **Configuration** tab, select your network adapter's TCP/IP entry and click **Properties**
- 2 Click the **IP Address** tab.
  - If your IP address is dynamic, select **Obtain an IP address automatically**.
  - If you have a static IP address, select **Specify an IP address** and type your information into the **IP Address** and **Subnet Mask** fields.

**Figure 208** Windows 95/98/Me: TCP/IP Properties: IP Address

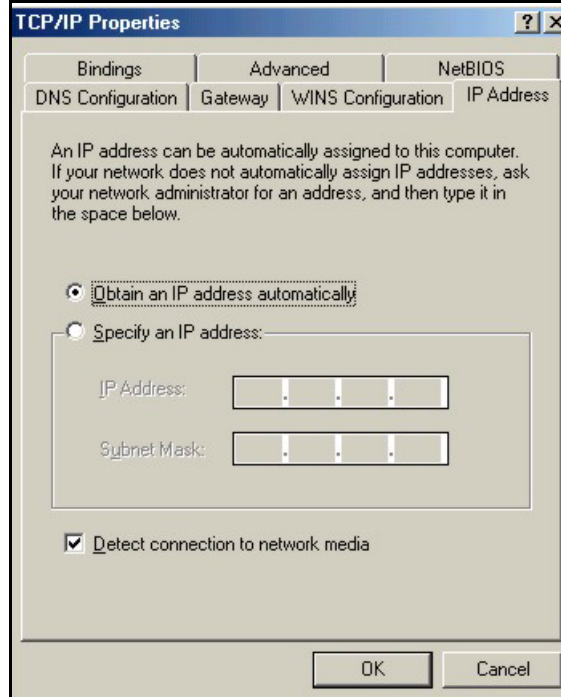

- 3 Click the **DNS Configuration** tab.
  - If you do not know your DNS information, select **Disable DNS**.
  - If you know your DNS information, select **Enable DNS** and type the information in the fields below (you may not need to fill them all in).

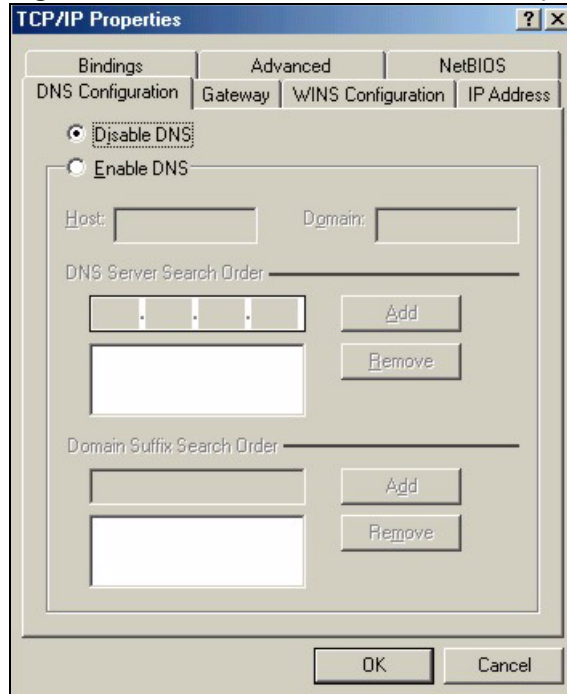
**Figure 209** Windows 95/98/Me: TCP/IP Properties: DNS Configuration

- 4 Click the **Gateway** tab.
  - If you do not know your gateway's IP address, remove previously installed gateways.
  - If you have a gateway IP address, type it in the **New gateway field** and click **Add**.
- 5 Click **OK** to save and close the **TCP/IP Properties** window.
- 6 Click **OK** to close the **Network** window. Insert the Windows CD if prompted.
- 7 Restart your computer when prompted.

## Verifying Settings

- 1 Click **Start** and then **Run**.
- 2 In the **Run** window, type "winipcfg" and then click **OK** to open the **IP Configuration** window.
- 3 Select your network adapter. You should see your computer's IP address, subnet mask and default gateway.

## Windows 2000/NT/XP

The following example figures use the default Windows XP GUI theme.

- 1 Click **start** (**Start** in Windows 2000/NT), **Settings**, **Control Panel**.

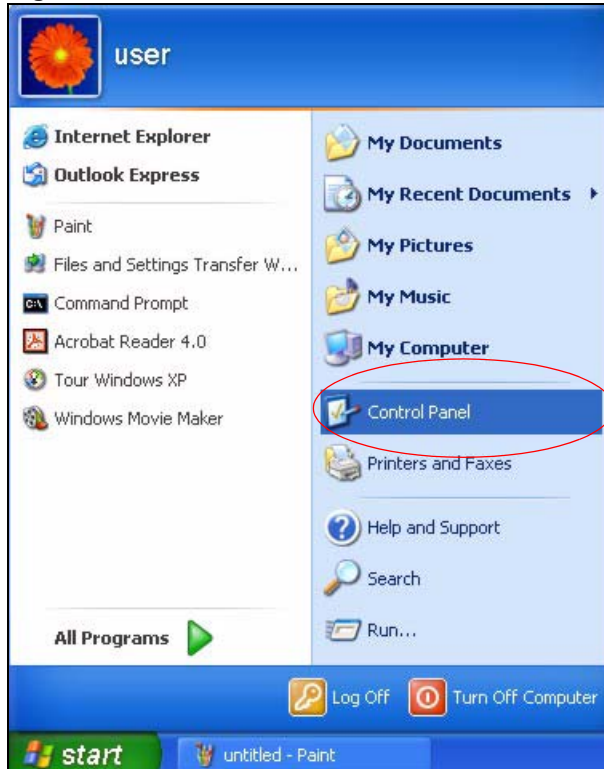
**Figure 210** Windows XP: Start Menu

- 2 In the **Control Panel**, double-click **Network Connections (Network and Dial-up Connections)** in Windows 2000/NT).

**Figure 211** Windows XP: Control Panel

- 3 Right-click **Local Area Connection** and then click **Properties**.

**Figure 212** Windows XP: Control Panel: Network Connections: Properties

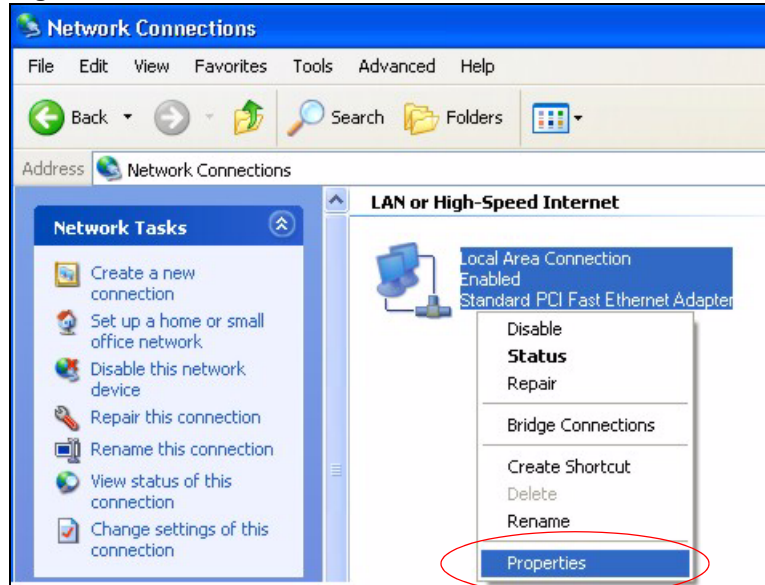

**4** Select **Internet Protocol (TCP/IP)** (under the **General** tab in Win XP) and then click **Properties**.

**Figure 213** Windows XP: Local Area Connection Properties

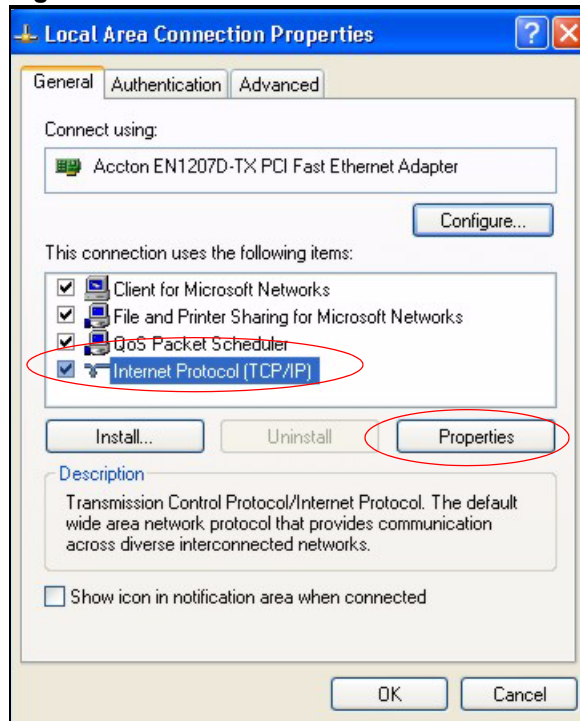

**5** The **Internet Protocol TCP/IP Properties** window opens (the **General** tab in Windows XP).

- If you have a dynamic IP address click **Obtain an IP address automatically**.
- If you have a static IP address click **Use the following IP Address** and fill in the **IP address**, **Subnet mask**, and **Default gateway** fields.
- Click **Advanced**.

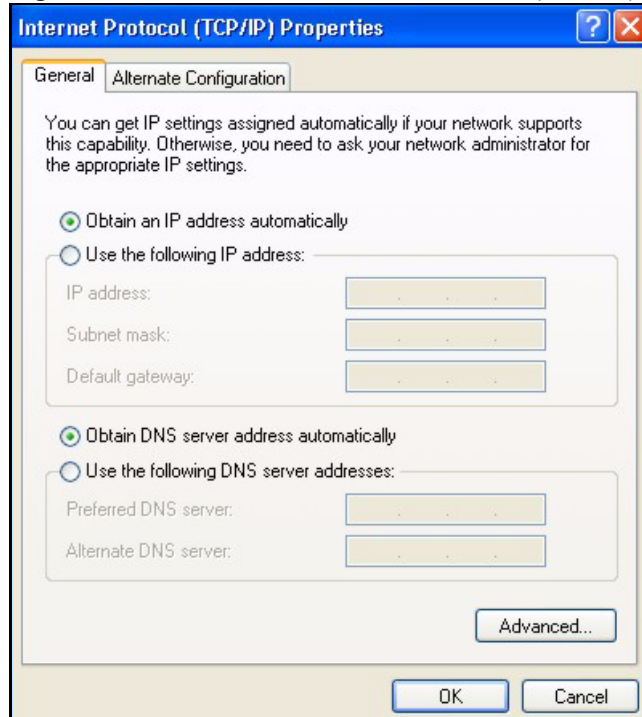
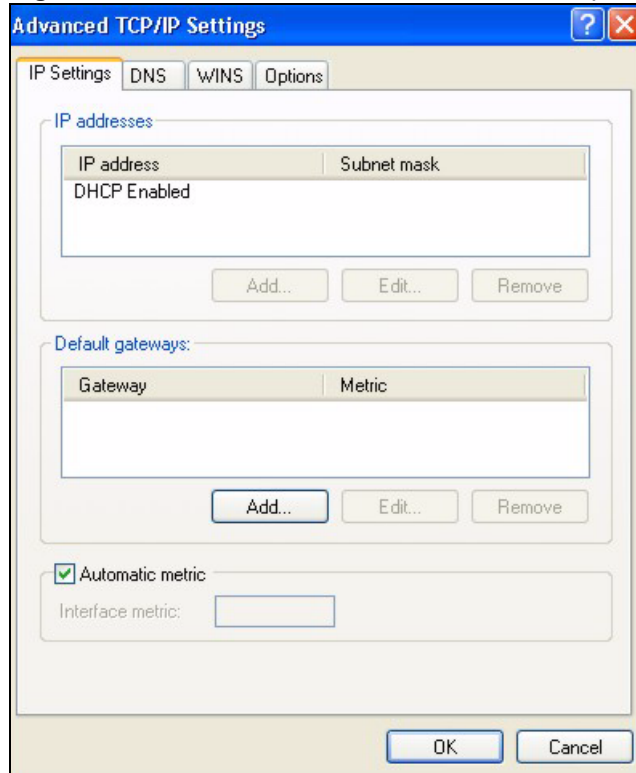

**Figure 214** Windows XP: Internet Protocol (TCP/IP) Properties

- 6** If you do not know your gateway's IP address, remove any previously installed gateways in the **IP Settings** tab and click **OK**.

Do one or more of the following if you want to configure additional IP addresses:

- In the **IP Settings** tab, in IP addresses, click **Add**.
- In **TCP/IP Address**, type an IP address in **IP address** and a subnet mask in **Subnet mask**, and then click **Add**.
- Repeat the above two steps for each IP address you want to add.
- Configure additional default gateways in the **IP Settings** tab by clicking **Add** in **Default gateways**.
- In **TCP/IP Gateway Address**, type the IP address of the default gateway in **Gateway**. To manually configure a default metric (the number of transmission hops), clear the **Automatic metric** check box and type a metric in **Metric**.
- Click **Add**.
- Repeat the previous three steps for each default gateway you want to add.
- Click **OK** when finished.

**Figure 215** Windows XP: Advanced TCP/IP Properties

**7** In the **Internet Protocol TCP/IP Properties** window (the **General** tab in Windows XP):

- Click **Obtain DNS server address automatically** if you do not know your DNS server IP address(es).
- If you know your DNS server IP address(es), click **Use the following DNS server addresses**, and type them in the **Preferred DNS server** and **Alternate DNS server** fields.

If you have previously configured DNS servers, click **Advanced** and then the **DNS** tab to order them.

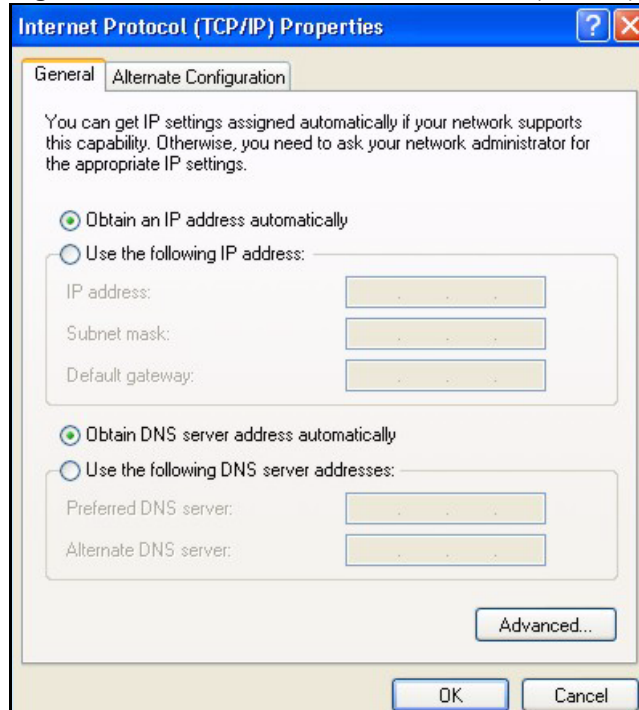
**Figure 216** Windows XP: Internet Protocol (TCP/IP) Properties

- 8 Click **OK** to close the **Internet Protocol (TCP/IP) Properties** window.
- 9 Click **Close (OK)** in Windows 2000/NT) to close the **Local Area Connection Properties** window.
- 10 Close the **Network Connections** window (**Network and Dial-up Connections** in Windows 2000/NT).
- 11 Restart your computer (if prompted).

## Verifying Settings

- 1 Click **Start, All Programs, Accessories** and then **Command Prompt**.
- 2 In the **Command Prompt** window, type "ipconfig" and then press [ENTER]. You can also open **Network Connections**, right-click a network connection, click **Status** and then click the **Support** tab.

## Macintosh OS X

- 1 Click the **Apple** menu, and click **System Preferences** to open the **System Preferences** window.

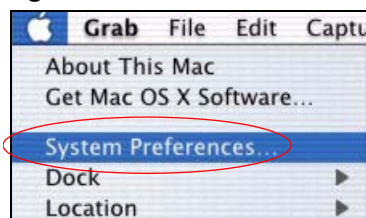
**Figure 217** Macintosh OS X: Apple Menu

- 2 Click **Network** in the icon bar.
  - Select **Automatic** from the **Location** list.
  - Select **Built-in Ethernet** from the **Show** list.
  - Click the **TCP/IP** tab.
- 3 For dynamically assigned settings, select **Using DHCP** from the **Configure** list.

Figure 218 Macintosh OS X: Network

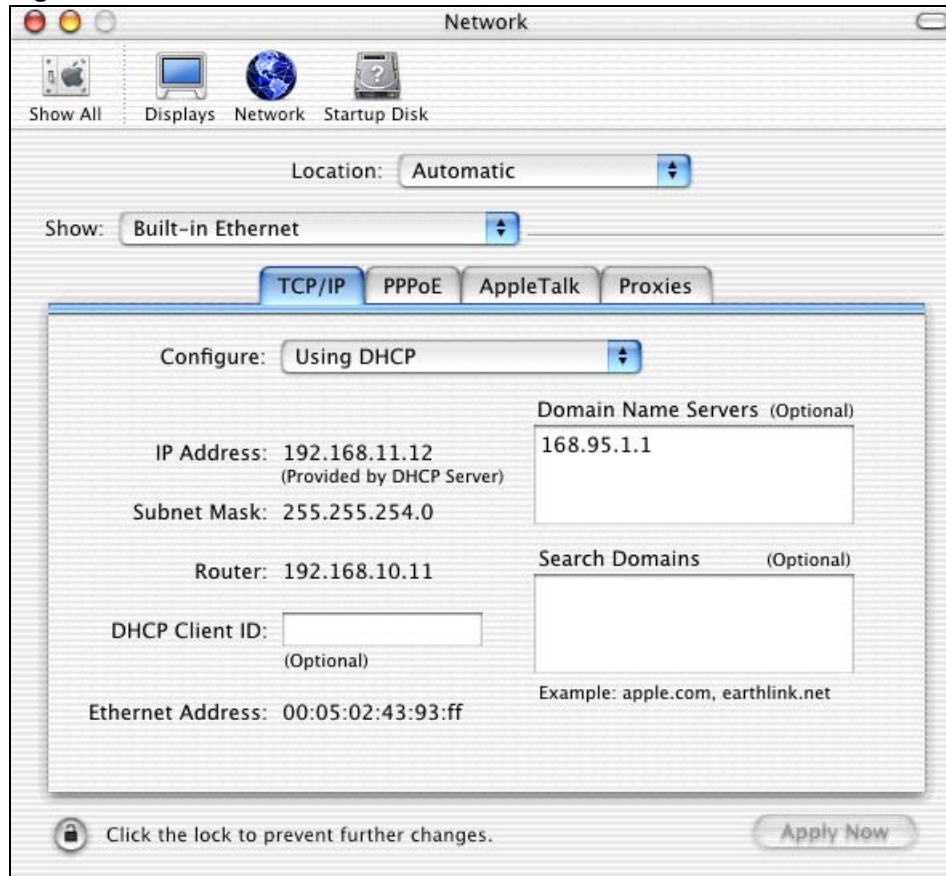

- 4 For statically assigned settings, do the following:
  - From the **Configure** box, select **Manually**.
  - Type your IP address in the **IP Address** box.
  - Type your subnet mask in the **Subnet mask** box.
  - Type the IP address of your gateway in the **Router address** box.
- 5 Click **Apply Now** and close the window.
- 6 Restart your computer (if prompted).

## Verifying Settings

Check your TCP/IP properties in the **Network** window.

## Linux

This section shows you how to configure your computer's TCP/IP settings in Red Hat Linux 9.0. Procedure, screens and file location may vary depending on your Linux distribution and release version.



**Make sure you are logged in as the root administrator.**

### Using the K Desktop Environment (KDE)

Follow the steps below to configure your computer IP address using the KDE.

- 1 Click the Red Hat button (located on the bottom left corner), select **System Setting** and click **Network**.

**Figure 219** Red Hat 9.0: KDE: Network Configuration: Devices

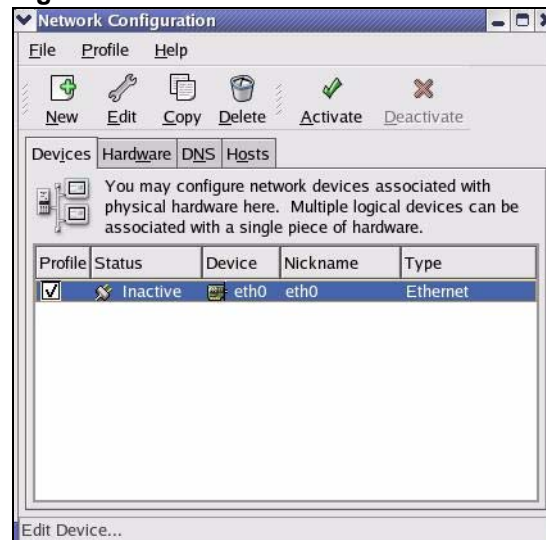

- 2 Double-click on the profile of the network card you wish to configure. The **Ethernet Device General** screen displays as shown.

**Figure 220** Red Hat 9.0: KDE: Ethernet Device: General

- If you have a dynamic IP address, click **Automatically obtain IP address settings with** and select **dhcp** from the drop down list.
  - If you have a static IP address, click **Statically set IP Addresses** and fill in the **Address**, **Subnet mask**, and **Default Gateway Address** fields.
- 3** Click **OK** to save the changes and close the **Ethernet Device General** screen.
  - 4** If you know your DNS server IP address(es), click the **DNS** tab in the **Network Configuration** screen. Enter the DNS server information in the fields provided.

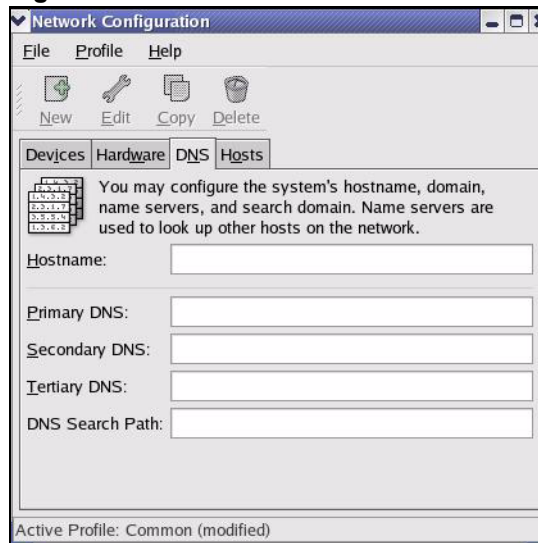
**Figure 221** Red Hat 9.0: KDE: Network Configuration: DNS

- 5** Click the **Devices** tab.
- 6** Click the **Activate** button to apply the changes. The following screen displays. Click **Yes to save the changes in all screens**.

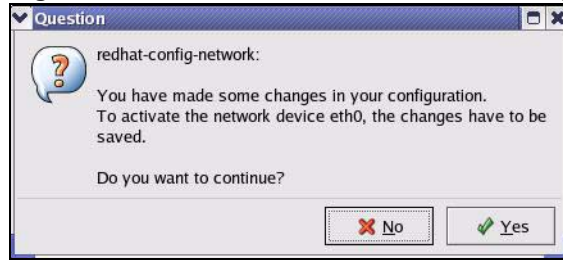
**Figure 222** Red Hat 9.0: KDE: Network Configuration: Activate

- 7 After the network card restart process is complete, make sure the **Status** is **Active** in the **Network Configuration** screen.

## Using Configuration Files

Follow the steps below to edit the network configuration files and set your computer IP address.

- 1 Assuming that you have only one network card on the computer, locate the `ifconfig-eth0` configuration file (where `eth0` is the name of the Ethernet card). Open the configuration file with any plain text editor.
  - If you have a dynamic IP address, enter **dhcp** in the `BOOTPROTO=` field. The following figure shows an example.

**Figure 223** Red Hat 9.0: Dynamic IP Address Setting in `ifconfig-eth0`

```
DEVICE=eth0
ONBOOT=yes
BOOTPROTO=dhcp
USERCTL=no
PEERDNS=yes
TYPE=Ethernet
```

- If you have a static IP address, enter **static** in the `BOOTPROTO=` field. Type `IPADDR=` followed by the IP address (in dotted decimal notation) and type `NETMASK=` followed by the subnet mask. The following example shows an example where the static IP address is 192.168.1.10 and the subnet mask is 255.255.255.0.

**Figure 224** Red Hat 9.0: Static IP Address Setting in `ifconfig-eth0`

```
DEVICE=eth0
ONBOOT=yes
BOOTPROTO=static
IPADDR=192.168.1.10
NETMASK=255.255.255.0
USERCTL=no
PEERDNS=yes
TYPE=Ethernet
```

- 2 If you know your DNS server IP address(es), enter the DNS server information in the `resolv.conf` file in the `/etc` directory. The following figure shows an example where two DNS server IP addresses are specified.

**Figure 225** Red Hat 9.0: DNS Settings in resolv.conf

```
nameserver 172.23.5.1
nameserver 172.23.5.2
```

- 3 After you edit and save the configuration files, you must restart the network card. Enter `./network restart` in the `/etc/rc.d/init.d` directory. The following figure shows an example.

**Figure 226** Red Hat 9.0: Restart Ethernet Card

```
[root@localhost init.d]# network restart

Shutting down interface eth0:                [OK]
Shutting down loopback interface:           [OK]
Setting network parameters:                 [OK]
Bringing up loopback interface:             [OK]
Bringing up interface eth0:                 [OK]
```

## Verifying Settings

Enter `ifconfig` in a terminal screen to check your TCP/IP properties.

**Figure 227** Red Hat 9.0: Checking TCP/IP Properties

```
[root@localhost]# ifconfig
eth0      Link encap:Ethernet HWaddr 00:50:BA:72:5B:44
          inet addr:172.23.19.129 Bcast:172.23.19.255 Mask:255.255.255.0
          UP BROADCAST RUNNING MULTICAST  MTU:1500  Metric:1
          RX packets:717 errors:0 dropped:0 overruns:0 frame:0
          TX packets:13 errors:0 dropped:0 overruns:0 carrier:0
          collisions:0 txqueuelen:100
          RX bytes:730412 (713.2 Kb) TX bytes:1570 (1.5 Kb)
          Interrupt:10 Base address:0x1000
[root@localhost]#
```



# SIP Passthrough

## Enabling/Disabling the SIP ALG

You can turn off the ZyXEL Device SIP ALG to avoid retranslating the IP address of an existing SIP device that is using STUN. If you want to use STUN with a SIP client device (a SIP phone or IP phone for example) behind the ZyXEL Device, use the `ip alg disable ALG_SIP` command to turn off the SIP ALG.

## Signaling Session Timeout

Most SIP clients have an “expire” mechanism indicating the lifetime of signaling sessions. The SIP UA sends registration packets to the SIP server periodically and keeps the session alive in the ZyXEL Device.

If the SIP client does not have this mechanism and makes no call during the ZyXEL Device SIP timeout default (60 minutes), the ZyXEL Device SIP ALG drops any incoming calls after the timeout period. You can use the `ip alg siptimeout` command to change the timeout value.

## Audio Session Timeout

If no voice packets go through the SIP ALG before the timeout period default (5 minutes) expires, the SIP ALG does not drop the call but blocks all voice traffic and deletes the audio session. You cannot hear anything and you will need to make a new call to continue your conversation.



# Internal SPTGEN

This appendix introduces Internal SPTGEN. All menus shown in this appendix are example menus meant to show SPTGEN usage. Actual menus for your product may differ.

## Internal SPTGEN Overview

Internal SPTGEN (System Parameter Table Generator) is a configuration text file useful for efficient configuration of multiple ZyXEL Devices. Internal SPTGEN lets you configure, save and upload multiple menus at the same time using just one configuration text file – eliminating the need to navigate and configure individual screens for each ZyXEL Device. You can use FTP to get the Internal SPTGEN file. Then edit the file in a text editor and use FTP to upload it again to the same device or another one. See the following sections for details.

## The Configuration Text File Format

All Internal SPTGEN text files conform to the following format:

```
<field identification number = field name = parameter values
allowed = input>,
```

where <input> is your input conforming to <parameter values allowed>.

The figure shown next is an example of an Internal SPTGEN text file.

**Figure 228** Configuration Text File Format: Column Descriptions

```
/ Menu 1 General Setup
10000000 = Configured          <0 (No) | 1 (Yes)>      = 1
10000001 = System Name        <Str>                  = Your Device
10000002 = Location           <Str>                  =
10000003 = Contact Person's Name <Str>                  =
10000004 = Route IP           <0 (No) | 1 (Yes)>      = 1
10000005 = Route IPX         <0 (No) | 1 (Yes)>      = 0
10000006 = Bridge            <0 (No) | 1 (Yes)>      = 0
```



**DO NOT alter or delete any field except parameters in the Input column.**

This appendix introduces Internal SPTGEN. All menus shown in this appendix are example menus meant to show SPTGEN usage. Actual menus for your product may differ.

## Internal SPTGEN File Modification - Important Points to Remember

Each parameter you enter must be preceded by one “=” sign and one space.

Some parameters are dependent on others. For example, if you disable the **Configured** field in menu 1 (see [Figure 228 on page 323](#)), then you disable every field in this menu.

If you enter a parameter that is invalid in the **Input** column, the ZyXEL Device will not save the configuration and the command line will display the **Field Identification Number**. [Figure 229 on page 324](#), shown next, is an example of what the ZyXEL Device displays if you enter a value other than “0” or “1” in the **Input** column of **Field Identification Number 1000000** (refer to [Figure 228 on page 323](#)).

**Figure 229** Invalid Parameter Entered: Command Line Example

```
field value is not legal error:-1
ROM-t is not saved, error Line ID:10000000
reboot to get the original configuration
Bootbase Version: V2.02 | 2/22/2001 13:33:11
RAM: Size = 8192 Kbytes
FLASH: Intel 8M *2
```

The ZyXEL Device will display the following if you enter parameter(s) that *are* valid.

**Figure 230** Valid Parameter Entered: Command Line Example

```
Please wait for the system to write SPT text file(ROM-t)...
Bootbase Version: V2.02 | 2/22/2001 13:33:11
RAM: Size = 8192 Kbytes
FLASH: Intel 8M *2
```

## Internal SPTGEN FTP Download Example

- 1 Launch your FTP application.
- 2 Enter "bin". The command “bin” sets the transfer mode to binary.
- 3 Get "rom-t" file. The command “get” transfers files from the ZyXEL Device to your computer. The name “rom-t” is the configuration filename on the ZyXEL Device.
- 4 Edit the "rom-t" file using a text editor (do not use a word processor). You must leave this FTP screen to edit.

**Figure 231** Internal SPTGEN FTP Download Example

```
c:\ftp 192.168.1.1
220 PPP FTP version 1.0 ready at Sat Jan 1 03:22:12 2000
User (192.168.1.1:(none)):
331 Enter PASS command
Password:
230 Logged in
ftp>bin
200 Type I OK
ftp> get rom-t
ftp>bye
c:\edit rom-t
(edit the rom-t text file by a text editor and save it)
```



**You can rename your “rom-t” file when you save it to your computer but it must be named “rom-t” when you upload it to your ZyXEL Device.**

## Internal SPTGEN FTP Upload Example

- 1 Launch your FTP application.
- 2 Enter "bin". The command “bin” sets the transfer mode to binary.
- 3 Upload your “rom-t” file from your computer to the ZyXEL Device using the “put” command. computer to the ZyXEL Device.
- 4 Exit this FTP application.

**Figure 232** Internal SPTGEN FTP Upload Example

```
c:\ftp 192.168.1.1
220 PPP FTP version 1.0 ready at Sat Jan 1 03:22:12 2000
User (192.168.1.1:(none)):
331 Enter PASS command
Password:
230 Logged in
ftp>bin
200 Type I OK
ftp> put rom-t
ftp>bye
```

## Example Internal SPTGEN Menus

This section provides example Internal SPTGEN menus.

**Table 144** Abbreviations Used in the Example Internal SPTGEN Screens Table

ABBREVIATION	MEANING
FIN	Field Identification Number
FN	Field Name
PVA	Parameter Values Allowed
INPUT	An example of what you may enter
*	Applies to the ZyXEL Device.

**Table 145** Menu 1 General Setup

/ Menu 1 General Setup			
FIN	FN	PVA	INPUT
10000000 =	Configured	<0 (No)   1 (Yes)>	= 0
10000001 =	System Name	<Str>	= Your Device
10000002 =	Location	<Str>	=
10000003 =	Contact Person's Name	<Str>	=
10000004 =	Route IP	<0 (No)   1 (Yes)>	= 1
10000006 =	Bridge	<0 (No)   1 (Yes)>	= 0

**Table 146** Menu 3

/ Menu 3.1 General Ethernet Setup			
FIN	FN	PVA	INPUT
30100001 =	Input Protocol filters Set 1		= 2
30100002 =	Input Protocol filters Set 2		= 256
30100003 =	Input Protocol filters Set 3		= 256
30100004 =	Input Protocol filters Set 4		= 256
30100005 =	Input device filters Set 1		= 256
30100006 =	Input device filters Set 2		= 256
30100007 =	Input device filters Set 3		= 256
30100008 =	Input device filters Set 4		= 256
30100009 =	Output protocol filters Set 1		= 256
30100010 =	Output protocol filters Set 2		= 256
30100011 =	Output protocol filters Set 3		= 256
30100012 =	Output protocol filters Set 4		= 256
30100013 =	Output device filters Set 1		= 256
30100014 =	Output device filters Set 2		= 256
30100015 =	Output device filters Set 3		= 256
30100016 =	Output device filters Set 4		= 256

**Table 146 Menu 3**

/ Menu 3.2 TCP/IP and DHCP Ethernet Setup			
FIN	FN	PVA	INPUT
30200001 =	DHCP	<0 (None)   1 (Server)   2 (Relay)>	= 0
30200002 =	Client IP Pool Starting Address		= 192.168.1.33
30200003 =	Size of Client IP Pool		= 32
30200004 =	Primary DNS Server		= 0.0.0.0
30200005 =	Secondary DNS Server		= 0.0.0.0
30200006 =	Remote DHCP Server		= 0.0.0.0
30200008 =	IP Address		= 172.21.2.200
30200009 =	IP Subnet Mask		= 16
30200010 =	RIP Direction	<0 (None)   1 (Both)   2 (In Only)   3 (Out Only)>	= 0
30200011 =	Version	<0 (Rip-1)   1 (Rip-2B)   2 (Rip-2M)>	= 0
30200012 =	Multicast	<0 (IGMP-v2)   1 (IGMP-v1)   2 (None)>	= 2
30200013 =	IP Policies Set 1 (1~12)		= 256
30200014 =	IP Policies Set 2 (1~12)		= 256
30200015 =	IP Policies Set 3 (1~12)		= 256
30200016 =	IP Policies Set 4 (1~12)		= 256
/ Menu 3.2.1 IP Alias Setup			
FIN	FN	PVA	INPUT
30201001 =	IP Alias 1	<0 (No)   1 (Yes)>	= 0
30201002 =	IP Address		= 0.0.0.0
30201003 =	IP Subnet Mask		= 0
30201004 =	RIP Direction	<0 (None)   1 (Both)   2 (In Only)   3 (Out Only)>	= 0
30201005 =	Version	<0 (Rip-1)   1 (Rip-2B)   2 (Rip-2M)>	= 0
30201006 =	IP Alias #1 Incoming protocol filters Set 1		= 256
30201007 =	IP Alias #1 Incoming protocol filters Set 2		= 256

**Table 146 Menu 3**

30201008 =	IP Alias #1 Incoming protocol filters Set 3		= 256	
30201009 =	IP Alias #1 Incoming protocol filters Set 4		= 256	
30201010 =	IP Alias #1 Outgoing protocol filters Set 1		= 256	
30201011 =	IP Alias #1 Outgoing protocol filters Set 2		= 256	
30201012 =	IP Alias #1 Outgoing protocol filters Set 3		= 256	
30201013 =	IP Alias #1 Outgoing protocol filters Set 4		= 256	
30201014 =	IP Alias 2 <0(No)   1(Yes)>		= 0	
30201015 =	IP Address		= 0.0.0.0	
30201016 =	IP Subnet Mask		= 0	
30201017 =	RIP Direction	<0(None)   1(Both)   2(In Only)   3(Out Only)>	= 0	
30201018 =	Version	<0(Rip-1)   1(Rip-2B)   2(Rip-2M)>	= 0	
30201019 =	IP Alias #2 Incoming protocol filters Set 1		= 256	
30201020 =	IP Alias #2 Incoming protocol filters Set 2		= 256	
30201021 =	IP Alias #2 Incoming protocol filters Set 3		= 256	
30201022 =	IP Alias #2 Incoming protocol filters Set 4		= 256	
30201023 =	IP Alias #2 Outgoing protocol filters Set 1		= 256	
30201024 =	IP Alias #2 Outgoing protocol filters Set 2		= 256	
30201025 =	IP Alias #2 Outgoing protocol filters Set 3		= 256	
30201026 =	IP Alias #2 Outgoing protocol filters Set 4		= 256	
*/ Menu 3.5 Wireless LAN Setup				
	FIN	FN	PVA	INPUT
30500001 =	ESSID			Wireless
30500002 =	Hide ESSID		<0(No)   1(Yes)>	= 0
30500003 =	Channel ID		<1 2 3 4 5 6 7 8 9 10 11 12 13>	= 1



**Table 146** Menu 3

30500004 =	RTS Threshold	<0 ~ 2432>	= 2432
30500005 =	FRAG. Threshold	<256 ~ 2432>	= 2432
30500006 =	WEP	<0(DISABLE)   1(64-bit WEP)   2(128-bit WEP)>	= 0
30500007 =	Default Key	<1 2 3 4>	= 0
30500008 =	WEP Key1		=
30500009 =	WEP Key2		=
30500010 =	WEP Key3		=
30500011 =	WEP Key4		=
30500012 =	Wlan Active	<0(Disable)   1(Enable)>	= 0
30500013 =	Wlan 4X Mode	<0(Disable)   1(Enable)>	= 0
*/ MENU 3.5.1 WLAN MAC ADDRESS FILTER			
FIN	FN	PVA	INPUT
30501001 =	Mac Filter Active	<0(No)   1(Yes)>	= 0
30501002 =	Filter Action	<0(Allow)   1(Deny)>	= 0
30501003 =	Address 1		= 00:00:00:00: 00:00
30501004 =	Address 2		= 00:00:00:00: 00:00
30501005 =	Address 3		= 00:00:00:00: 00:00
Continued	...		...
30501034 =	Address 32		= 00:00:00:00: 00:00

**Table 147** Menu 4 Internet Access Setup

/ Menu 4 Internet Access Setup			
FIN	FN	PVA	INPUT
40000000 =	Configured	<0(No)   1(Yes)>	= 1
40000001 =	ISP	<0(No)   1(Yes)>	= 1
40000002 =	Active	<0(No)   1(Yes)>	= 1

**Table 147** Menu 4 Internet Access Setup (continued)

40000003 =	ISP's Name		= ChangeMe
40000004 =	Encapsulation	<2 (PPPOE)   3 (RFC 1483)   4 (PPPoA )   5 (ENET ENCAP)>	= 2
40000005 =	Multiplexing	<1 (LLC-based)   2 (VC-based)>	= 1
40000006 =	VPI #		= 0
40000007 =	VCI #		= 35
40000008 =	Service Name	<Str>	= any
40000009 =	My Login	<Str>	= test@pqa
40000010 =	My Password	<Str>	= 1234
40000011 =	Single User Account	<0 (No)   1 (Yes)>	= 1
40000012 =	IP Address Assignment	<0 (Static)   1 (Dynamic)>	= 1
40000013 =	IP Address		= 0.0.0.0
40000014 =	Remote IP address		= 0.0.0.0
40000015 =	Remote IP subnet mask		= 0
40000016 =	ISP incoming protocol filter set 1		= 6
40000017 =	ISP incoming protocol filter set 2		= 256
40000018 =	ISP incoming protocol filter set 3		= 256
40000019 =	ISP incoming protocol filter set 4		= 256
40000020 =	ISP outgoing protocol filter set 1		= 256
40000021 =	ISP outgoing protocol filter set 2		= 256
40000022 =	ISP outgoing protocol filter set 3		= 256
40000023 =	ISP outgoing protocol filter set 4		= 256
40000024 =	ISP PPPoE idle timeout		= 0
40000025 =	Route IP	<0 (No)   1 (Yes)>	= 1
40000026 =	Bridge	<0 (No)   1 (Yes)>	= 0
40000027 =	ATM QoS Type	<0 (CBR)   (1 (UBR)>	= 1
40000028 =	Peak Cell Rate (PCR)		= 0
40000029 =	Sustain Cell Rate (SCR)		= 0
40000030 =	Maximum Burst Size (MBS)		= 0
40000031 =	RIP Direction	<0 (None)   1 (Both)   2 (In Only)   3 (Out Only)>	= 0

**Table 147** Menu 4 Internet Access Setup (continued)

40000032=	RIP Version	<0(Rip-1)   1(Rip-2B)  2(Rip-2M)>	= 0
40000033=	Nailed-up Connection	<0(No)  1(Yes)>	= 0

**Table 148** Menu 12

/ Menu 12.1.1 IP Static Route Setup			
FIN	FN	PVA	INPUT
120101001 =	IP Static Route set #1, Name	<Str>	=
120101002 =	IP Static Route set #1, Active	<0(No)  1(Yes)>	= 0
120101003 =	IP Static Route set #1, Destination IP address		= 0.0.0.0
120101004 =	IP Static Route set #1, Destination IP subnetmask		= 0
120101005 =	IP Static Route set #1, Gateway		= 0.0.0.0
120101006 =	IP Static Route set #1, Metric		= 0
120101007 =	IP Static Route set #1, Private	<0(No)  1(Yes)>	= 0
/ Menu 12.1.2 IP Static Route Setup			
FIN	FN	PVA	INPUT
120108001 =	IP Static Route set #8, Name	<Str>	=
120108002 =	IP Static Route set #8, Active	<0(No)  1(Yes)>	= 0
120108003 =	IP Static Route set #8, Destination IP address		= 0.0.0.0
120108004 =	IP Static Route set #8, Destination IP subnetmask		= 0
120108005 =	IP Static Route set #8, Gateway		= 0.0.0.0
120108006 =	IP Static Route set #8, Metric		= 0
120108007 =	IP Static Route set #8, Private	<0(No)  1(Yes)>	= 0

**Table 149** Menu 15 SUA Server Setup

/ Menu 15 SUA Server Setup			
FIN	FN	PVA	INPUT
150000001 =	SUA Server IP address for default port		= 0.0.0.0
150000002 =	SUA Server #2 Active	<0(No)   1(Yes)>	= 0
150000003 =	SUA Server #2 Protocol	<0(All)  6(TCP)  17(U DP)>	= 0
150000004 =	SUA Server #2 Port Start		= 0
150000005 =	SUA Server #2 Port End		= 0
150000006 =	SUA Server #2 Local IP address		= 0.0.0.0

**Table 149** Menu 15 SUA Server Setup (continued)

150000007 =	SUA Server #3 Active	<0 (No)   1 (Yes)>	= 0
150000008 =	SUA Server #3 Protocol	<0 (All)   6 (TCP)   17 (UDP)>	= 0
150000009 =	SUA Server #3 Port Start		= 0
150000010 =	SUA Server #3 Port End		= 0
150000011 =	SUA Server #3 Local IP address		= 0.0.0.0
150000012 =	SUA Server #4 Active	<0 (No)   1 (Yes)>	= 0
150000013 =	SUA Server #4 Protocol	<0 (All)   6 (TCP)   17 (UDP)>	= 0
150000014 =	SUA Server #4 Port Start		= 0
150000015 =	SUA Server #4 Port End		= 0
150000016 =	SUA Server #4 Local IP address		= 0.0.0.0
150000017 =	SUA Server #5 Active	<0 (No)   1 (Yes)>	= 0
150000018 =	SUA Server #5 Protocol	<0 (All)   6 (TCP)   17 (UDP)>	= 0
150000019 =	SUA Server #5 Port Start		= 0
150000020 =	SUA Server #5 Port End		= 0
150000021 =	SUA Server #5 Local IP address		= 0.0.0.0
150000022 =	SUA Server #6 Active	<0 (No)   1 (Yes)> = 0	= 0
150000023 =	SUA Server #6 Protocol	<0 (All)   6 (TCP)   17 (UDP)>	= 0
150000024 =	SUA Server #6 Port Start		= 0
150000025 =	SUA Server #6 Port End		= 0
150000026 =	SUA Server #6 Local IP address		= 0.0.0.0
150000027 =	SUA Server #7 Active	<0 (No)   1 (Yes)>	= 0
150000028 =	SUA Server #7 Protocol	<0 (All)   6 (TCP)   17 (UDP)>	= 0.0.0.0
150000029 =	SUA Server #7 Port Start		= 0
150000030 =	SUA Server #7 Port End		= 0
150000031 =	SUA Server #7 Local IP address		= 0.0.0.0
150000032 =	SUA Server #8 Active	<0 (No)   1 (Yes)>	= 0
150000033 =	SUA Server #8 Protocol	<0 (All)   6 (TCP)   17 (UDP)>	= 0
150000034 =	SUA Server #8 Port Start		= 0
150000035 =	SUA Server #8 Port End		= 0
150000036 =	SUA Server #8 Local IP address		= 0.0.0.0
150000037 =	SUA Server #9 Active	<0 (No)   1 (Yes)>	= 0
150000038 =	SUA Server #9 Protocol	<0 (All)   6 (TCP)   17 (UDP)>	= 0
150000039 =	SUA Server #9 Port Start		= 0
150000040 =	SUA Server #9 Port End		= 0

**Table 149** Menu 15 SUA Server Setup (continued)

150000041 =	SUA Server #9 Local IP address		= 0.0.0.0
150000042	= SUA Server #10 Active	<0 (No)   1 (Yes)>	= 0
150000043 =	SUA Server #10 Protocol	<0 (All)   6 (TCP)   17 (UDP)>	= 0
150000044 =	SUA Server #10 Port Start		= 0
150000045 =	SUA Server #10 Port End		= 0
150000046 =	SUA Server #10 Local IP address		= 0.0.0.0
150000047 =	SUA Server #11 Active	<0 (No)   1 (Yes)>	= 0
150000048 =	SUA Server #11 Protocol	<0 (All)   6 (TCP)   17 (UDP)>	= 0
150000049 =	SUA Server #11 Port Start		= 0
150000050 =	SUA Server #11 Port End		= 0
150000051 =	SUA Server #11 Local IP address		= 0.0.0.0
150000052 =	SUA Server #12 Active	<0 (No)   1 (Yes)>	= 0
150000053 =	SUA Server #12 Protocol	<0 (All)   6 (TCP)   17 (UDP)>	= 0
150000054 =	SUA Server #12 Port Start		= 0
150000055 =	SUA Server #12 Port End		= 0
150000056 =	SUA Server #12 Local IP address		= 0.0.0.0

**Table 150** Menu 21.1 Filter Set #1

/ Menu 21 Filter set #1			
FIN	FN	PVA	INPUT
210100001 =	Filter Set 1, Name	<Str>	=
/ Menu 21.1.1.1 set #1, rule #1			
FIN	FN	PVA	INPUT
210101001 =	IP Filter Set 1, Rule 1 Type	<2 (TCP/IP)>	= 2
210101002 =	IP Filter Set 1, Rule 1 Active	<0 (No)   1 (Yes)>	= 1
210101003 =	IP Filter Set 1, Rule 1 Protocol		= 6
210101004 =	IP Filter Set 1, Rule 1 Dest IP address		= 0.0.0.0
210101005 =	IP Filter Set 1, Rule 1 Dest Subnet Mask		= 0
210101006 =	IP Filter Set 1, Rule 1 Dest Port		= 137
210101007 =	IP Filter Set 1, Rule 1 Dest Port Comp	<0 (none)   1 (equal)   2 (not equal)   3 (less)   4 (greater)>	= 1
210101008 =	IP Filter Set 1, Rule 1 Src IP address		= 0.0.0.0
210101009 =	IP Filter Set 1, Rule 1 Src Subnet Mask		= 0
210101010 =	IP Filter Set 1, Rule 1 Src Port		= 0

**Table 150** Menu 21.1 Filter Set #1 (continued)

210101011 =	IP Filter Set 1,Rule 1 Src Port Comp	<0 (none)  1 (equal)  2 (not equal)  3 (less)  4 (greater)>	= 0
210101013 =	IP Filter Set 1,Rule 1 Act Match	<1 (check next)  2 (forward)  3 (drop)>	= 3
210101014 =	IP Filter Set 1,Rule 1 Act Not Match	<1 (check next)  2 (forward)  3 (drop)>	= 1
/ Menu 21.1.1.2 set #1, rule #2			
FIN	FN	PVA	INPUT
210102001 =	IP Filter Set 1,Rule 2 Type	<2 (TCP/IP)>	= 2
210102002 =	IP Filter Set 1,Rule 2 Active	<0 (No)  1 (Yes)>	= 1
210102003 =	IP Filter Set 1,Rule 2 Protocol		= 6
210102004 =	IP Filter Set 1,Rule 2 Dest IP address		= 0.0.0.0
210102005 =	IP Filter Set 1,Rule 2 Dest Subnet Mask		= 0
210102006 =	IP Filter Set 1,Rule 2 Dest Port		= 138
210102007 =	IP Filter Set 1,Rule 2 Dest Port Comp	<0 (none)  1 (equal)  2 (not equal)  3 (less)  4 (greater)>	= 1
210102008 =	IP Filter Set 1,Rule 2 Src IP address		= 0.0.0.0
210102009 =	IP Filter Set 1,Rule 2 Src Subnet Mask		= 0
210102010 =	IP Filter Set 1,Rule 2 Src Port		= 0
210102011 =	IP Filter Set 1,Rule 2 Src Port Comp	<0 (none)  1 (equal)  2 (not equal)  3 (less)  4 (greater)>	= 0
210102013 =	IP Filter Set 1,Rule 2 Act Match	<1 (check next)  2 (forward)  3 (drop)>	= 3
210102014 =	IP Filter Set 1,Rule 2 Act Not Match	<1 (check next)  2 (forward)  3 (drop)>	= 1

**Table 151** Menu 21.1 Filter Set #2

/ Menu 21.1 filter set #2,			
FIN	FN	PVA	INPUT
210200001 =	Filter Set 2, Nam	<Str>	= NetBIOS_WAN
/ Menu 21.1.2.1 Filter set #2, rule #1			
FIN	FN	PVA	INPUT

**Table 151** Menu 21.1 Filer Set #2 (continued)

210201001 =	IP Filter Set 2, Rule 1 Type	<0 (none)   2 (TCP/ IP)>	= 2
210201002 =	IP Filter Set 2, Rule 1 Active	<0 (No)   1 (Yes)>	= 1
210201003 =	IP Filter Set 2, Rule 1 Protocol		= 6
210201004 =	IP Filter Set 2, Rule 1 Dest IP address		= 0.0.0.0
210201005 =	IP Filter Set 2, Rule 1 Dest Subnet Mask		= 0
210201006 =	IP Filter Set 2, Rule 1 Dest Port		= 137
210201007 =	IP Filter Set 2, Rule 1 Dest Port Comp	<0 (none)   1 (equal)   2 (not equal)   3 (less)   4 (greater)>	= 1
210201008 =	IP Filter Set 2, Rule 1 Src IP address		= 0.0.0.0
210201009 =	IP Filter Set 2, Rule 1 Src Subnet Mask		= 0
210201010 =	IP Filter Set 2, Rule 1 Src Port		= 0
210201011 =	IP Filter Set 2, Rule 1 Src Port Comp	<0 (none)   1 (equal)   2 (not equal)   3 (less)   4 (greater)>	= 0
210201013 =	IP Filter Set 2, Rule 1 Act Match	<1 (check next)   2 (forward)   3 (drop)>	= 3
210201014 =	IP Filter Set 2, Rule 1 Act Not Match	<1 (check next)   2 (forward)   3 (drop)>	= 1
/ Menu 21.1.2.2 Filter set #2, rule #2			
FIN	FN	PVA	INPUT
210202001 =	IP Filter Set 2, Rule 2 Type	<0 (none)   2 (TCP/ IP)>	= 2
210202002 =	IP Filter Set 2, Rule 2 Active	<0 (No)   1 (Yes)>	= 1
210202003 =	IP Filter Set 2, Rule 2 Protocol		= 6
210202004 =	IP Filter Set 2, Rule 2 Dest IP address		= 0.0.0.0
210202005 =	IP Filter Set 2, Rule 2 Dest Subnet Mask		= 0
210202006 =	IP Filter Set 2, Rule 2 Dest Port		= 138
210202007 =	IP Filter Set 2, Rule 2 Dest Port Comp	<0 (none)   1 (equal)   2 (not equal)   3 (less)   4 (greater)>	= 1
210202008 =	IP Filter Set 2, Rule 2 Src IP address		= 0.0.0.0
210202009 =	IP Filter Set 2, Rule 2 Src Subnet Mask		= 0

**Table 151** Menu 21.1 Filer Set #2 (continued)

210202010 =	IP Filter Set 2,Rule 2 Src Port		= 0
210202011 =	IP Filter Set 2, Rule 2 Src Port Comp	<0 (none)  1 (equal)   2 (not equal)  3 (less)  4 (greater)>	= 0
210202013 =	IP Filter Set 2, Rule 2 Act Match	<1 (check next)  2 (forward)  3 (drop)>	= 3
210202014 =	IP Filter Set 2, Rule 2 Act Not Match	<1 (check next)  2 (forward)  3 (drop)>	= 1

**Table 152** Menu 23 System Menus

*/ Menu 23.1 System Password Setup			
FIN	FN	PVA	INPUT
230000000 =	System Password		= 1234
*/ Menu 23.2 System security: radius server			
FIN	FN	PVA	INPUT
230200001 =	Authentication Server Configured	<0 (No)   1 (Yes)>	= 1
230200002 =	Authentication Server Active	<0 (No)   1 (Yes)>	= 1
230200003 =	Authentication Server IP Address		= 192.168.1.32
230200004 =	Authentication Server Port		= 1822
230200005 =	Authentication Server Shared Secret		= 111111111111 111 111111111111 1111
230200006 =	Accounting Server Configured	<0 (No)   1 (Yes)>	= 1
230200007 =	Accounting Server Active	<0 (No)   1 (Yes)>	= 1
230200008 =	Accounting Server IP Address		= 192.168.1.44
230200009 =	Accounting Server Port		= 1823
230200010 =	Accounting Server Shared Secret		= 1234
*/ Menu 23.4 System security: IEEE802.1x			
FIN	FN	PVA	INPUT
230400001 =	Wireless Port Control	<0 (Authentication Required)  1 (No Access Allowed)  2 (No Authentication Required)>	= 2
230400002 =	ReAuthentication Timer (in second)		= 555
230400003 =	Idle Timeout (in second)		= 999



**Table 152** Menu 23 System Menus (continued)

230400004 =	Authentication Databases	<0 (Local User Database Only)  1 (RADIUS Only)  2 (Local, RADIUS)  3 (RADIUS, Local)>	= 1
230400005 =	Key Management Protocol	<0 (8021x)  1 (WPA)  2 (WPAPSK)>	= 0
230400006 =	Dynamic WEP Key Exchange	<0 (Disable)  1 (64-bit WEP)  2 (128-bit WEP)>	= 0
230400007 =	PSK =		=
230400008 =	WPA Mixed Mode	<0 (Disable)  1 (Enable)>	= 0
230400009 =	Data Privacy for Broadcast/ Multicast packets	<0 (TKIP)  1 (WEP)>	= 0
230400010 =	WPA Broadcast/Multicast Key Update Timer		= 0

**Table 153** Menu 24.11 Remote Management Control

/ Menu 24.11 Remote Management Control			
FIN	FN	PVA	INPUT
241100001 =	TELNET Server Port		= 23
241100002 =	TELNET Server Access	<0 (all)  1 (none)  2 (Lan)  3 (Wan)>	= 0
241100003 =	TELNET Server Secured IP address		= 0.0.0.0
241100004 =	FTP Server Port		= 21
241100005 =	FTP Server Access	<0 (all)  1 (none)  2 (Lan)  3 (Wan)>	= 0
241100006 =	FTP Server Secured IP address		= 0.0.0.0
241100007 =	WEB Server Port		= 80
241100008 =	WEB Server Access	<0 (all)  1 (none)  2 (Lan)  3 (Wan)>	= 0
241100009 =	WEB Server Secured IP address		= 0.0.0.0

## Command Examples

The following are example Internal SPTGEN screens associated with the ZyXEL Device's command interpreter commands.

**Table 154** Command Examples

FIN	FN	PVA	INPUT
/ci command (for annex a): wan adsl opencmd			
FIN	FN	PVA	INPUT
990000001 =	ADSL OPMD	<0 (glite)  1 (t1.413 )  2 (gdm)  3 (multimode)>	= 3
/ci command (for annex B): wan adsl opencmd			
FIN	FN	PVA	INPUT
990000001 =	ADSL OPMD	<0 (etsi)  1 (normal)  2 (gdm)  3 (multimode)>	= 3

## Services

The following table lists some commonly-used services and their associated protocols and port numbers.

- **Name:** This is a short, descriptive name for the service. You can use this one or create a different one, if you like.
- **Protocol:** This is the type of IP protocol used by the service. If this is **TCP/UDP**, then the service uses the same port number with TCP and UDP. If this is **User-Defined**, the **Port(s)** is the IP protocol number, not the port number.
- **Port(s):** This value depends on the **Protocol**.
  - If the **Protocol** is **TCP, UDP, or TCP/UDP**, this is the IP port number.
  - If the **Protocol** is **User-Defined**, this is the IP protocol number.
- **Description:** This is a brief explanation of the applications that use this service or the situations in which this service is used.

**Table 155** Examples of Services

NAME	PROTOCOL	PORT(S)	DESCRIPTION
AH (IPSEC_TUNNEL)	User-Defined	51	The IPSEC AH (Authentication Header) tunneling protocol uses this service.
AIM	TCP	5190	AOL's Internet Messenger service.
AUTH	TCP	113	Authentication protocol used by some servers.
BGP	TCP	179	Border Gateway Protocol.
BOOTP_CLIENT	UDP	68	DHCP Client.
BOOTP_SERVER	UDP	67	DHCP Server.
CU-SEEME	TCP/UDP TCP/UDP	7648 24032	A popular videoconferencing solution from White Pines Software.
DNS	TCP/UDP	53	Domain Name Server, a service that matches web names (e.g. <a href="http://www.zyxel.com">www.zyxel.com</a> ) to IP numbers.
ESP (IPSEC_TUNNEL)	User-Defined	50	The IPSEC ESP (Encapsulation Security Protocol) tunneling protocol uses this service.
FINGER	TCP	79	Finger is a UNIX or Internet related command that can be used to find out if a user is logged on.
FTP	TCP TCP	20 21	File Transfer Program, a program to enable fast transfer of files, including large files that may not be possible by e-mail.

**Table 155** Examples of Services (continued)

NAME	PROTOCOL	PORT(S)	DESCRIPTION
H.323	TCP	1720	NetMeeting uses this protocol.
HTTP	TCP	80	Hyper Text Transfer Protocol - a client/server protocol for the world wide web.
HTTPS	TCP	443	HTTPS is a secured http session often used in e-commerce.
ICMP	User-Defined	1	Internet Control Message Protocol is often used for diagnostic purposes.
ICQ	UDP	4000	This is a popular Internet chat program.
IGMP (MULTICAST)	User-Defined	2	Internet Group Multicast Protocol is used when sending packets to a specific group of hosts.
IKE	UDP	500	The Internet Key Exchange algorithm is used for key distribution and management.
IMAP4	TCP	143	The Internet Message Access Protocol is used for e-mail.
IMAP4S	TCP	993	This is a more secure version of IMAP4 that runs over SSL.
IRC	TCP/UDP	6667	This is another popular Internet chat program.
MSN Messenger	TCP	1863	Microsoft Networks' messenger service uses this protocol.
NetBIOS	TCP/UDP TCP/UDP TCP/UDP TCP/UDP	137 138 139 445	The Network Basic Input/Output System is used for communication between computers in a LAN.
NEW-ICQ	TCP	5190	An Internet chat program.
NEWS	TCP	144	A protocol for news groups.
NFS	UDP	2049	Network File System - NFS is a client/server distributed file service that provides transparent file sharing for network environments.
NNTP	TCP	119	Network News Transport Protocol is the delivery mechanism for the USENET newsgroup service.
PING	User-Defined	1	Packet INternet Groper is a protocol that sends out ICMP echo requests to test whether or not a remote host is reachable.
POP3	TCP	110	Post Office Protocol version 3 lets a client computer get e-mail from a POP3 server through a temporary connection (TCP/IP or other).
POP3S	TCP	995	This is a more secure version of POP3 that runs over SSL.
PPTP	TCP	1723	Point-to-Point Tunneling Protocol enables secure transfer of data over public networks. This is the control channel.

**Table 155** Examples of Services (continued)

NAME	PROTOCOL	PORT(S)	DESCRIPTION
PPTP_TUNNEL (GRE)	User-Defined	47	PPTP (Point-to-Point Tunneling Protocol) enables secure transfer of data over public networks. This is the data channel.
RCMD	TCP	512	Remote Command Service.
REAL_AUDIO	TCP	7070	A streaming audio service that enables real time sound over the web.
REXEC	TCP	514	Remote Execution Daemon.
RLOGIN	TCP	513	Remote Login.
ROADRUNNER	TCP/UDP	1026	This is an ISP that provides services mainly for cable modems.
RTELNET	TCP	107	Remote Telnet.
RTSP	TCP/UDP	554	The Real Time Streaming (media control) Protocol (RTSP) is a remote control for multimedia on the Internet.
SFTP	TCP	115	The Simple File Transfer Protocol is an old way of transferring files between computers.
SMTP	TCP	25	Simple Mail Transfer Protocol is the message-exchange standard for the Internet. SMTP enables you to move messages from one e-mail server to another.
SMTPS	TCP	465	This is a more secure version of SMTP that runs over SSL.
SNMP	TCP/UDP	161	Simple Network Management Program.
SNMP-TRAPS	TCP/UDP	162	Traps for use with the SNMP (RFC:1215).
SQL-NET	TCP	1521	Structured Query Language is an interface to access data on many different types of database systems, including mainframes, midrange systems, UNIX systems and network servers.
SSDP	UDP	1900	The Simple Service Discovery Protocol supports Universal Plug-and-Play (UPnP).
SSH	TCP/UDP	22	Secure Shell Remote Login Program.
STRM WORKS	UDP	1558	Stream Works Protocol.
SYSLOG	UDP	514	Syslog allows you to send system logs to a UNIX server.
TACACS	UDP	49	Login Host Protocol used for (Terminal Access Controller Access Control System).
TELNET	TCP	23	Telnet is the login and terminal emulation protocol common on the Internet and in UNIX environments. It operates over TCP/IP networks. Its primary function is to allow users to log into remote host systems.

**Table 155** Examples of Services (continued)

<b>NAME</b>	<b>PROTOCOL</b>	<b>PORT(S)</b>	<b>DESCRIPTION</b>
TFTP	UDP	69	Trivial File Transfer Protocol is an Internet file transfer protocol similar to FTP, but uses the UDP (User Datagram Protocol) rather than TCP (Transmission Control Protocol).
VDOLIVE	TCP UDP	7000 user- defined	A videoconferencing solution. The UDP port number is specified in the application.

# Legal Information

## Copyright

Copyright © 2006 by ZyXEL Communications Corporation.

The contents of this publication may not be reproduced in any part or as a whole, transcribed, stored in a retrieval system, translated into any language, or transmitted in any form or by any means, electronic, mechanical, magnetic, optical, chemical, photocopying, manual, or otherwise, without the prior written permission of ZyXEL Communications Corporation.

Published by ZyXEL Communications Corporation. All rights reserved.

## Disclaimer

ZyXEL does not assume any liability arising out of the application or use of any products, or software described herein. Neither does it convey any license under its patent rights nor the patent rights of others. ZyXEL further reserves the right to make changes in any products described herein without notice. This publication is subject to change without notice.

## Trademarks

ZyNOS (ZyXEL Network Operating System) is a registered trademark of ZyXEL Communications, Inc. Other trademarks mentioned in this publication are used for identification purposes only and may be properties of their respective owners.

## Certifications

### Federal Communications Commission (FCC) Interference Statement

The device complies with Part 15 of FCC rules. Operation is subject to the following two conditions:

- This device may not cause harmful interference.
- This device must accept any interference received, including interference that may cause undesired operations.

This device has been tested and found to comply with the limits for a Class B digital device pursuant to Part 15 of the FCC Rules. These limits are designed to provide reasonable protection against harmful interference in a residential installation. This device generates, uses, and can radiate radio frequency energy, and if not installed and used in accordance with the instructions, may cause harmful interference to radio communications. However, there is no guarantee that interference will not occur in a particular installation.

If this device does cause harmful interference to radio/television reception, which can be determined by turning the device off and on, the user is encouraged to try to correct the interference by one or more of the following measures:

- 1 Reorient or relocate the receiving antenna.
- 2 Increase the separation between the equipment and the receiver.
- 3 Connect the equipment into an outlet on a circuit different from that to which the receiver is connected.
- 4 Consult the dealer or an experienced radio/TV technician for help.



### FCC Radiation Exposure Statement

- This transmitter must not be co-located or operating in conjunction with any other antenna or transmitter.
- IEEE 802.11b or 802.11g operation of this product in the U.S.A. is firmware-limited to channels 1 through 11.
- To comply with FCC RF exposure compliance requirements, a separation distance of at least 20 cm must be maintained between the antenna of this device and all persons.

## 注意！

依據 低功率電波輻射性電機管理辦法

第十二條 經型式認證合格之低功率射頻電機，非經許可，公司、商號或使用者均不得擅自變更頻率、加大功率或變更原設計之特性及功能。

第十四條 低功率射頻電機之使用不得影響飛航安全及干擾合法通信；經發現有干擾現象時，應立即停用，並改善至無干擾時方得繼續使用。前項合法通信，指依電信規定作業之無線電信。低功率射頻電機須忍受合法通信或工業、科學及醫療用電波輻射性電機設備之干擾。

本機限在不干擾合法電臺與不受被干擾保障條件下於室內使用。  
減少電磁波影響，請妥適使用。

### Notices

Changes or modifications not expressly approved by the party responsible for compliance could void the user's authority to operate the equipment.

This device has been designed for the WLAN 2.4 GHz network throughout the EC region and Switzerland, with restrictions in France.

This Class B digital apparatus complies with Canadian ICES-003.

Cet appareil numérique de la classe B est conforme à la norme NMB-003 du Canada.

### Viewing Certifications

- 1 Go to <http://www.zyxel.com>.
- 2 Select your product on the ZyXEL home page to go to that product's page.



- 3 Select the certification you wish to view from this page.

## ZyXEL Limited Warranty

ZyXEL warrants to the original end user (purchaser) that this product is free from any defects in materials or workmanship for a period of up to two years from the date of purchase. During the warranty period, and upon proof of purchase, should the product have indications of failure due to faulty workmanship and/or materials, ZyXEL will, at its discretion, repair or replace the defective products or components without charge for either parts or labor, and to whatever extent it shall deem necessary to restore the product or components to proper operating condition. Any replacement will consist of a new or re-manufactured functionally equivalent product of equal or higher value, and will be solely at the discretion of ZyXEL. This warranty shall not apply if the product has been modified, misused, tampered with, damaged by an act of God, or subjected to abnormal working conditions.

### Note

Repair or replacement, as provided under this warranty, is the exclusive remedy of the purchaser. This warranty is in lieu of all other warranties, express or implied, including any implied warranty of merchantability or fitness for a particular use or purpose. ZyXEL shall in no event be held liable for indirect or consequential damages of any kind to the purchaser.

To obtain the services of this warranty, contact ZyXEL's Service Center for your Return Material Authorization number (RMA). Products must be returned Postage Prepaid. It is recommended that the unit be insured when shipped. Any returned products without proof of purchase or those with an out-dated warranty will be repaired or replaced (at the discretion of ZyXEL) and the customer will be billed for parts and labor. All repaired or replaced products will be shipped by ZyXEL to the corresponding return address, Postage Paid. This warranty gives you specific legal rights, and you may also have other rights that vary from country to country.

### Registration

Register your product online to receive e-mail notices of firmware upgrades and information at [www.zyxel.com](http://www.zyxel.com) for global products, or at [www.us.zyxel.com](http://www.us.zyxel.com) for North American products.





# Customer Support

Please have the following information ready when you contact customer support.

## Required Information

- Product model and serial number.
- Warranty Information.
- Date that you received your device.
- Brief description of the problem and the steps you took to solve it.

## Corporate Headquarters (Worldwide)

- Support E-mail: [support@zyxel.com.tw](mailto:support@zyxel.com.tw)
- Sales E-mail: [sales@zyxel.com.tw](mailto:sales@zyxel.com.tw)
- Telephone: +886-3-578-3942
- Fax: +886-3-578-2439
- Web Site: [www.zyxel.com](http://www.zyxel.com), [www.europe.zyxel.com](http://www.europe.zyxel.com)
- FTP Site: [ftp.zyxel.com](ftp://ftp.zyxel.com), [ftp.europe.zyxel.com](ftp://ftp.europe.zyxel.com)
- Regular Mail: ZyXEL Communications Corp., 6 Innovation Road II, Science Park, Hsinchu 300, Taiwan

## Costa Rica

- Support E-mail: [soporte@zyxel.co.cr](mailto:soporte@zyxel.co.cr)
- Sales E-mail: [sales@zyxel.co.cr](mailto:sales@zyxel.co.cr)
- Telephone: +506-2017878
- Fax: +506-2015098
- Web Site: [www.zyxel.co.cr](http://www.zyxel.co.cr)
- FTP Site: [ftp.zyxel.co.cr](ftp://ftp.zyxel.co.cr)
- Regular Mail: ZyXEL Costa Rica, Plaza Roble Escazú, Etapa El Patio, Tercer Piso, San José, Costa Rica

## Czech Republic

- E-mail: [info@cz.zyxel.com](mailto:info@cz.zyxel.com)
- Telephone: +420-241-091-350
- Fax: +420-241-091-359
- Web Site: [www.zyxel.cz](http://www.zyxel.cz)
- Regular Mail: ZyXEL Communications, Czech s.r.o., Modranská 621, 143 01 Praha 4 - Modrany, Česká Republika

### **Denmark**

- Support E-mail: support@zyxel.dk
- Sales E-mail: sales@zyxel.dk
- Telephone: +45-39-55-07-00
- Fax: +45-39-55-07-07
- Web Site: www.zyxel.dk
- Regular Mail: ZyXEL Communications A/S, Columbusvej, 2860 Soeborg, Denmark

### **Finland**

- Support E-mail: support@zyxel.fi
- Sales E-mail: sales@zyxel.fi
- Telephone: +358-9-4780-8411
- Fax: +358-9-4780 8448
- Web Site: www.zyxel.fi
- Regular Mail: ZyXEL Communications Oy, Malminkaari 10, 00700 Helsinki, Finland

### **France**

- E-mail: info@zyxel.fr
- Telephone: +33-4-72-52-97-97
- Fax: +33-4-72-52-19-20
- Web Site: www.zyxel.fr
- Regular Mail: ZyXEL France, 1 rue des Vergers, Bat. 1 / C, 69760 Limonest, France

### **Germany**

- Support E-mail: support@zyxel.de
- Sales E-mail: sales@zyxel.de
- Telephone: +49-2405-6909-0
- Fax: +49-2405-6909-99
- Web Site: www.zyxel.de
- Regular Mail: ZyXEL Deutschland GmbH., Adenauerstr. 20/A2 D-52146, Wuerselen, Germany

### **Hungary**

- Support E-mail: support@zyxel.hu
- Sales E-mail: info@zyxel.hu
- Telephone: +36-1-3361649
- Fax: +36-1-3259100
- Web Site: www.zyxel.hu
- Regular Mail: ZyXEL Hungary, 48, Zoldlomb Str., H-1025, Budapest, Hungary

### **Kazakhstan**

- Support: <http://zyxel.kz/support>
- Sales E-mail: sales@zyxel.kz

- Telephone: +7-3272-590-698
- Fax: +7-3272-590-689
- Web Site: [www.zyxel.kz](http://www.zyxel.kz)
- Regular Mail: ZyXEL Kazakhstan, 43, Dostyk ave., Office 414, Dostyk Business Centre, 050010, Almaty, Republic of Kazakhstan

### North America

- Support E-mail: [support@zyxel.com](mailto:support@zyxel.com)
- Sales E-mail: [sales@zyxel.com](mailto:sales@zyxel.com)
- Telephone: +1-800-255-4101, +1-714-632-0882
- Fax: +1-714-632-0858
- Web Site: [www.us.zyxel.com](http://www.us.zyxel.com)
- FTP Site: <ftp.us.zyxel.com>
- Regular Mail: ZyXEL Communications Inc., 1130 N. Miller St., Anaheim, CA 92806-2001, U.S.A.

### Norway

- Support E-mail: [support@zyxel.no](mailto:support@zyxel.no)
- Sales E-mail: [sales@zyxel.no](mailto:sales@zyxel.no)
- Telephone: +47-22-80-61-80
- Fax: +47-22-80-61-81
- Web Site: [www.zyxel.no](http://www.zyxel.no)
- Regular Mail: ZyXEL Communications A/S, Nils Hansens vei 13, 0667 Oslo, Norway

### Poland

- E-mail: [info@pl.zyxel.com](mailto:info@pl.zyxel.com)
- Telephone: +48 (22) 333 8250
- Fax: +48 (22) 333 8251
- Web Site: [www.pl.zyxel.com](http://www.pl.zyxel.com)
- Regular Mail: ZyXEL Communications, ul. Okrzei 1A, 03-715 Warszawa, Poland

### Russia

- Support: <http://zyxel.ru/support>
- Sales E-mail: [sales@zyxel.ru](mailto:sales@zyxel.ru)
- Telephone: +7-095-542-89-29
- Fax: +7-095-542-89-25
- Web Site: [www.zyxel.ru](http://www.zyxel.ru)
- Regular Mail: ZyXEL Russia, Ostrovityanova 37a Str., Moscow, 117279, Russia

### Spain

- Support E-mail: [support@zyxel.es](mailto:support@zyxel.es)
- Sales E-mail: [sales@zyxel.es](mailto:sales@zyxel.es)
- Telephone: +34-902-195-420
- Fax: +34-913-005-345

- Web Site: [www.zyxel.es](http://www.zyxel.es)
- Regular Mail: ZyXEL Communications, Arte, 21 5ª planta, 28033 Madrid, Spain

### **Sweden**

- Support E-mail: [support@zyxel.se](mailto:support@zyxel.se)
- Sales E-mail: [sales@zyxel.se](mailto:sales@zyxel.se)
- Telephone: +46-31-744-7700
- Fax: +46-31-744-7701
- Web Site: [www.zyxel.se](http://www.zyxel.se)
- Regular Mail: ZyXEL Communications A/S, Sjöporten 4, 41764 Göteborg, Sweden

### **Ukraine**

- Support E-mail: [support@ua.zyxel.com](mailto:support@ua.zyxel.com)
- Sales E-mail: [sales@ua.zyxel.com](mailto:sales@ua.zyxel.com)
- Telephone: +380-44-247-69-78
- Fax: +380-44-494-49-32
- Web Site: [www.ua.zyxel.com](http://www.ua.zyxel.com)
- Regular Mail: ZyXEL Ukraine, 13, Pimonenko Str., Kiev, 04050, Ukraine

### **United Kingdom**

- Support E-mail: [support@zyxel.co.uk](mailto:support@zyxel.co.uk)
- Sales E-mail: [sales@zyxel.co.uk](mailto:sales@zyxel.co.uk)
- Telephone: +44-1344 303044, 08707 555779 (UK only)
- Fax: +44-1344 303034
- Web Site: [www.zyxel.co.uk](http://www.zyxel.co.uk)
- FTP Site: [ftp.zyxel.co.uk](ftp://ftp.zyxel.co.uk)
- Regular Mail: ZyXEL Communications UK, Ltd., 11 The Courtyard, Eastern Road, Bracknell, Berkshire, RG12 2XB, United Kingdom (UK)

“+” is the (prefix) number you dial to make an international telephone call.

# Index

## A

AbS (Analysis-by-Synthesis) [132](#)  
 Access Point, see AP [79](#)  
 adding a printer example [235](#)  
 adding a printer example, Macintosh OS [240](#)  
 Address Resolution Protocol (ARP) [109](#)  
 alert settings [261](#)  
 ALG [119](#)  
   and SIP [119](#)  
 ALG (Application Layer Gateway) [119](#)  
 alternative subnet mask notation [301](#)  
 analog phone [141](#)  
 Analysis-by-Synthesis (AbS) [132](#)  
 Any IP  
   note [109](#)  
 Any IP example [108](#)  
 Any IP feature [108](#)  
   and NAT [109](#)  
   setup [115](#)  
 AP (Access Point) [79](#)  
 application based bandwidth management [198](#)  
 Application Layer Gateway, see ALG [119](#)  
 auto attendant, and VoIP trunking [165](#)  
 auto-discovering UPnP-enabled network devices [221](#)  
 automatic log out [41](#)

## B

backing up configuration [275](#)  
 backup gateway [104](#)  
 bandwidth borrowing [201](#)  
 bandwidth borrowing example [201](#)  
 bandwidth classes [197](#)  
 bandwidth filters [197](#)  
 bandwidth management [197](#)  
   and LAN [203](#)  
   and WAN [203](#)  
   and WLAN [204](#)  
   application based [198](#)  
   bandwidth classes [197](#)  
   borrowing [201](#)  
   budgeting [197](#)  
   classes [205](#)

  fairness-based [200](#)  
   general [62](#)  
   monitor [207](#)  
   over allotment [202](#)  
   overview [197](#)  
   priority [64](#)  
   priority-based [199](#)  
   reserving [199](#)  
   services [63](#)  
   subnet-based [198](#)  
   unused & unbudgeted [200](#)  
   web configurator [203](#)  
   wizard setup [60](#)  
 base station  
   DECT [147](#)  
 blinking LEDs [37](#)  
 blocking calls [155](#)  
 blocking services via firewall [184](#)  
 borrowing bandwidth [201](#)  
 browsing, to a file share [247](#)

## C

call blocking [155](#)  
 call forwarding [155](#)  
 call hold [142](#), [144](#)  
 call rules, and VoIP trunking [163](#)  
 call service mode [142](#), [143](#), [153](#)  
 call transfer [143](#), [144](#)  
 call waiting [143](#), [144](#)  
 certifications [343](#)  
   notices [344](#)  
   viewing [344](#)  
 changing the password [40](#)  
 CIFS (Common Internet File System) [244](#)  
 circuit-switched telephone networks [127](#)  
 Class of Service (CoS) [133](#)  
 client-server protocol, and SIP [128](#)  
 codec (coder/decoder) [131](#)  
 codecs  
   and required bandwidth [132](#)  
   and VoIP [131](#)  
   hybrid waveform [132](#)  
   waveform [131](#)  
 coder/decoder, see also codecs [131](#)

command interface [210](#)  
Common Internet File System (CIFS) [244](#)  
computer's IP address [307](#)  
configuration  
    successful upload [277](#)  
    web configurator [275](#)  
contact information [347](#)  
content filtering [187](#), [188](#), [189](#)  
    scheduling [187](#)  
copyright [343](#)  
CoS [133](#)  
CoS (Class of Service) [133](#)  
cost of transmission  
    and WAN [101](#)  
custom tones [132](#), [139](#)  
customer support [347](#)

## D

data screening [179](#)  
DECT [147](#)  
    and flashing [150](#)  
    and PIN for registration [148](#)  
    and PSTN [150](#)  
    and SIP [150](#)  
    and supplementary services [150](#)  
    and VoIP [150](#)  
    base station [147](#)  
    base station button [147](#)  
    base station reset [149](#)  
    external calls [150](#)  
    handset [147](#)  
    internal calls [150](#)  
    phone registration [147](#)  
    phone usage [149](#)  
    security [148](#)  
    SIP line assignment [151](#)  
    web configurator [150](#)  
DECT (Digital Enhanced Cordless  
    Telecommunications) [34](#)  
default  
    LAN IP address [39](#)  
    management IP address [287](#)  
    management subnet mask [287](#)  
    password [40](#), [287](#)  
    settings [41](#)  
    static route [194](#)  
DHCP [96](#), [253](#), [255](#)  
    IP address pool [111](#)  
    reserving IP addresses [111](#)  
    server [110](#)  
    setup [110](#)  
DHCP (Dynamic Host Configuration Protocol) [106](#)

DHCP clients [96](#), [112](#), [253](#), [289](#)  
DHCP server [106](#)  
DHCP setup [106](#)  
Differentiated Services, see DiffServ [133](#)  
DiffServ [133](#), [289](#)  
    marking rule [134](#)  
DiffServ (Differentiated Services) [133](#)  
DiffServ Code Points (DSCPs) [133](#)  
Digital Enhanced Cordless Telecommunications, See  
    DECT [34](#)  
dimensions [287](#)  
disclaimer [343](#)  
DNS [106](#)  
    and ISP [96](#)  
    and LAN [107](#), [111](#)  
    and WAN [255](#)  
    secondary [106](#)  
    servers [96](#), [102](#), [106](#)  
DNS (Domain Name System) [53](#)  
domain name [50](#), [253](#)  
Domain Name System (DNS) [53](#)  
DS field [133](#)  
DSCPs [133](#)  
DSCPs (DiffServ Code Points) [133](#)  
DTMF [138](#)  
    and telephone keys [132](#)  
DTMF (Dual-Tone Multi-Frequency) [132](#)  
Dual-Tone Multi-Frequency, see DTMF [132](#)  
Dynamic DNS [255](#)  
Dynamic Host Configuration Protocol, see DHCP [106](#)

## E

echo cancellation, and VoIP [141](#)  
emergency numbers [159](#)  
enabling WLAN [83](#)  
encapsulation  
    and WAN [98](#)  
    types of [98](#)  
encryption  
    WEP [85](#)  
encryption and WLAN [81](#)  
encryption key [81](#)  
error logging [261](#)  
Ethernet [48](#), [51](#), [97](#)  
Ethernet ports [287](#)  
ETSI (European Telecommunications Standards  
    Institute) [147](#)  
Europe type call service mode [142](#)  
event logs [261](#)



**F**

factory defaults [41](#)  
 fairness-based bandwidth management [200](#)  
 FAT (File Allocation Table) [243](#)  
 fax passthrough [289](#)  
 FCC interference statement [343](#)  
 File Allocation Table, see FAT [243](#)  
 file sharing [35](#), [243](#), [244](#)  
   and workgroup [244](#), [248](#)  
   overview [243](#)  
   user account [245](#)  
   web configurator [245](#)  
   Windows Explorer [247](#)  
 filtering Internet content, see also content filtering [187](#)  
 firewall  
   and NAT [120](#), [180](#), [183](#)  
   and WAN [103](#)  
   blocking services [184](#)  
   LAN [180](#)  
   LAN-to-WAN [180](#)  
   logging [184](#)  
   overview [179](#)  
   rules [180](#)  
   scheduling blocking [185](#)  
   sessions [183](#)  
   triangle route problem [181](#)  
   WAN [180](#)  
   WAN-to-LAN [181](#)  
   web configurator [183](#)  
 firmware [273](#)  
   error [275](#)  
   upload [274](#)  
 fixed IP address [52](#)  
 flash key [142](#)  
 flashing  
   and DECT phones [150](#)  
   commands [142](#), [143](#)  
 flashing, (using the flash key) [142](#)  
 Foreign Exchange Office (FXO) [287](#)  
 Foreign Exchange Station (FXS) [287](#)  
 frequency, and VoIP [132](#)  
 FTP [209](#), [255](#)  
 FTP restrictions [209](#)  
 FXO (Foreign Exchange Office) [287](#)  
 FXS (Foreign Exchange Station) [287](#)

**G**

G.168 [141](#)  
 G.168 Echo Cancellation [289](#)

G.711 [131](#)  
 G.711, waveform codec [289](#)  
 G.729 [132](#)  
 G.729, AbS hybrid waveform codec [289](#)  
 GAP [34](#)  
 GAP (Generic Access Profile) [147](#)  
 gateway IP address [53](#)  
 gateway, and static route [194](#)  
 Generic Access Profile, see GAP [147](#)

**H**

heartbeat packets, and WAN [97](#)  
 hide SSID [83](#)  
 HTTP [273](#)  
 HTTP (Hypertext Transfer Protocol) [273](#)  
 hybrid waveform codec [132](#)

**I**

IANA [306](#)  
 idle timeout [210](#)  
 IEEE 802.1Q VLAN [134](#)  
 IEEE 802.1x [80](#)  
 IGD 1.0 (Internet Gateway Device) [218](#)  
 IGMP [103](#)  
   and LAN [107](#)  
   and WAN [103](#)  
   versions [108](#)  
 IGMP (Internet Group Multicast Protocol) [107](#)  
 incoming call policy [155](#)  
 information security [179](#)  
 installing UPnP [218](#)  
   Windows Me [218](#)  
   Windows XP [219](#)  
 Interactive Voice Response, see IVR [132](#)  
 internal SPTGEN [323](#)  
   FTP upload example [325](#)  
   points to remember [324](#)  
   text file sample [323](#)  
 internal SPTGEN (System Parameter Table  
 GENerator) [323](#)  
 Internet access [35](#)  
 Internet Assigned Numbers AuthoritySee IANA [306](#)  
 Internet connection [48](#)  
 Internet content filtering, see also content filtering [187](#)  
 Internet Explorer [39](#)

Internet Gateway Device (IGD) [218](#)  
Internet Group Multicast protocol, see IGMP [107](#)  
Internet Service Provider (ISP) [50](#)  
Internet Telephony Service Provider (ITSP) [127](#)  
IP address  
  and ISP [52, 105](#)  
  and LAN [105, 110](#)  
  and WAN [95](#)  
  private range [95](#)  
  recommendation [96](#)  
IP alias [113](#)  
IP network and PSTN connection [161](#)  
IP-PBX [127](#)  
ISP  
  and IP address [105](#)  
  and WAN [96, 97](#)  
  Roadrunner [98](#)  
ISP (Internet Service Provider) [50](#)  
ISP and DNS [106](#)  
ISP parameters [50](#)  
ITSP (Internet Telephony Service Provider) [127](#)  
ITU-T, standards body [141](#)  
IVR [139](#)  
IVR (Interactive Voice Response) [132](#)

## J

Java permissions [39](#)  
JavaScripts [39](#)

## K

keyword blocking example [188](#)  
keyword filtering [187](#)

## L

LAN [105](#)  
  advanced setup [114](#)  
  and DHCP [106](#)  
  and DNS [107, 111](#)  
  and IGMP [107](#)  
  and IP address [110](#)  
  and multicasting [107](#)  
  and NAT [105, 108](#)  
  and NetBIOS [115](#)  
  and remote management [209](#)

  and RIP [107](#)  
  and routing [109](#)  
  and static DHCP [111](#)  
  and USB printer [229](#)  
  clients [112](#)  
  firewall [180](#)  
  IP address [105](#)  
  IP alias [113](#)  
  overview [105](#)  
  subnet mask [105](#)  
  subnets [108](#)  
  web configurator [110](#)  
LAN IP address  
  default [39](#)  
LEDs [36](#)  
log messages [265](#)  
log settings [262, 263](#)  
logging out [41](#)  
login [40](#)  
logs [261](#)  
logs, event [261](#)  
logs, traffic [261](#)

## M

MAC (Media Access Control) [96](#)  
MAC address [96](#)  
  and WAN [96](#)  
  and WLAN [80](#)  
  spoofing [55, 96](#)  
MAC address filter  
  actions [92](#)  
  WLAN [91](#)  
management features [290](#)  
Management Information Base (MIB) [213](#)  
management IP address [287](#)  
managing the device  
  good habits [36](#)  
  using FTP. See FTP.  
  using Telnet. See command interface.  
  using the command interface. See command interface.  
maximizing bandwidth usage [199, 203](#)  
Media Access Control, see MAC [96](#)  
Message Waiting Indication, see MWI [132](#)  
metric  
  and WAN [101](#)  
  static route [195](#)  
model types [33](#)  
monitoring bandwidth usage [207](#)  
multicasting [103, 107](#)  
  and LAN [107](#)

multimedia and SIP [127](#)  
 MWI [138](#)  
 MWI (Message Waiting Indication) [132](#)

## N

nailed-up connection [100](#)  
 NAT [131](#), [306](#)  
   and Any IP [109](#)  
   and firewall [120](#), [180](#), [183](#)  
   and LAN [105](#), [108](#)  
   and remote management [209](#)  
   and UPnP [217](#)  
   and VoIP [130](#), [138](#)  
   overview [117](#)  
   port forwarding [118](#)  
   server sets [117](#)  
   trigger ports [118](#)  
   web configurator [119](#)  
 NAT (Network Address Translation) [117](#)  
 NAT traversal [217](#)  
 navigating the web configurator [42](#), [43](#)  
 NetBIOS  
   and LAN [115](#)  
   and WAN [115](#)  
 NetBIOS (Network Basic Input/Output System) [103](#)  
 Netscape Navigator [39](#)  
 Network Address Translation, see NAT [117](#)  
 network number [105](#)  
 non-proxy calls [157](#)  
 NTP time servers [257](#)

## O

One-Touch Intelligent Security Technology, see  
 OTIST [82](#)  
 operation humidity [287](#)  
 operation temperature [287](#)  
 OTIST  
   clients [90](#)  
   WLAN [88](#)  
 OTIST (One-Touch Intelligent Security Technology)  
[82](#)  
 outbound proxy [130](#), [131](#)  
 over allotment of bandwidth [202](#)

## P

password [40](#), [287](#)  
   changing [40](#)  
 PCM (Pulse Code Modulation) [131](#)  
 peer call authentication, VoIP trunking [162](#)  
 Peer IP [167](#)  
 Peer Port [167](#)  
 peer-to-peer calls [33](#), [157](#)  
 Personal Identification Number, see PIN [148](#)  
 PHB (Per-Hop Behavior) [134](#)  
 phone  
   and VoIP [141](#)  
 phone book [155](#)  
   speed dial [157](#)  
 phone ports [287](#)  
 PIN (Personal Identification Number) [148](#)  
 PIN, and DECT phone [148](#)  
 ping responses [215](#)  
 Point-to-Point Protocol over Ethernet see PPPoE [51](#)  
 pop-up blocking [39](#)  
 port forwarding [117](#)  
   example [118](#)  
   services [117](#)  
   setup [120](#)  
 ports [37](#)  
 PPPoE [54](#), [95](#)  
   and WAN [99](#)  
 PPPoE (Point-to-Point Protocol over Ethernet) [51](#)  
 pre-defined NTP time servers [257](#)  
 print server [35](#)  
 printer sharing [229](#)  
   and LAN [229](#)  
   configuration [230](#)  
   requirements [229](#)  
   TCP/IP port [230](#)  
   web configurator [234](#)  
 priority-based bandwidth management [199](#)  
 product registration [345](#)  
 proportional bandwidth allocation [198](#)  
 protocol support [289](#)  
 proxy server, and SIP [129](#)  
 PSTN  
   and DECT [150](#)  
 PSTN (Public Switched Telephone Network) [132](#)  
 PSTN line [159](#)  
   and power outage [159](#)  
   and web configurator [160](#)  
   relay [160](#)  
 Public Switched Telephone Network, see PSTN [132](#)  
 Pulse Code Modulation (PCM) [131](#)  
 pulse dialing [132](#)

**Q**

- QoS [133](#), [289](#)
  - and VoIP [127](#), [133](#), [134](#), [139](#)
- QoS (Quality of Service) [133](#)
- Quality of Service, see QoS [133](#)

**R**

- RADIUS [81](#), [86](#)
  - and WLAN [80](#), [86](#)
- Real Time Transport (RTP) [130](#)
- recommendations for security [180](#)
- recording custom tones [132](#)
- redirect server, and SIP [129](#)
- register server, and SIP [130](#)
- registration
  - product [345](#)
- related documentation [3](#)
- remote management [209](#)
  - and LAN [209](#)
  - and NAT [209](#)
  - and WAN [209](#)
  - limitations [209](#)
  - priorities [209](#)
  - security [215](#)
  - web configurator [210](#)
- required bandwidth, and VoIP [132](#)
- reserving bandwidth [199](#)
- RESET button [42](#), [276](#)
- resetting the time [258](#)
- resetting to factory defaults [41](#)
- restoring configuration [275](#)
- restrict web features [188](#)
- RFC 1305 [259](#)
- RFC 1466 [96](#)
- RFC 1597 [96](#)
- RFC 1889 [130](#)
- RFC 2516 [95](#)
- RFC 3489 [131](#)
- RFC 3842 [132](#)
- RFC 867 [259](#)
- RFC 868 [259](#)
- RIP
  - and LAN [107](#)
  - direction [107](#)
  - versions [107](#)
- RIP (Routing Information Protocol) [107](#)
- Roadrunner [98](#)

- router features [35](#)
- routing [107](#), [109](#), [193](#)
- Routing Information Protocol, see RIP [107](#)
- RTP (Real Time Transport) [130](#)

**S**

- safety warnings [6](#)
- scheduler, and bandwidth management [198](#)
- security
  - alert settings [261](#)
  - data screening [179](#)
  - DECT phone [148](#)
  - firewall [179](#)
  - guidelines [180](#)
  - remote management [215](#)
- service mode
  - and analog telephone [142](#)
- Service Set IDentity, see SSID [79](#)
- Session Initiation Protocol, see SIP [127](#)
- sharing files [244](#)
- silence suppression, and VoIP [141](#)
- silence suppression, phone feature [289](#)
- silent packets, and VAD [141](#)
- Simple Network Management Protocol, see SNMP [212](#)
- SIP [127](#)
  - account [57](#)
  - accounts [127](#)
  - and DECT [150](#)
  - and multimedia sessions [127](#)
  - and VoIP [127](#)
  - call progression [128](#)
  - client-server protocol [128](#)
  - identities [127](#)
  - number [127](#)
  - outbound proxy [131](#)
  - proxy server [129](#)
  - redirect server [129](#)
  - register server [130](#)
  - server address [58](#)
  - servers [128](#)
  - service domain [128](#)
  - settings [57](#), [134](#)
  - user agent [128](#)
- SIP (Session Initiation Protocol) [127](#)
- SIP ALG [119](#), [130](#)
- SIP ALG (Application Layer Gateway) [119](#)
- SIP URI (Uniform Resource Identifier) [127](#)
- SNMP
  - manager [212](#)
  - MIBs [213](#)

SNMP (Simple Network Management Protocol) [212](#)  
 sound quality, and VoIP [131](#)  
 specification tables [287](#)  
 speed dial [157](#)  
 spoofing the MAC address [55, 96](#)  
 SSID [80](#)  
   hiding [83](#)  
 SSID (Service Set IDentity) [79](#)  
 SSID and security [80](#)  
 stateful inspection [179](#)  
 static route [193](#)  
   default [194](#)  
   gateway [194](#)  
   metric [195](#)  
   overview [193](#)  
 static WEP [81, 85](#)  
 status bar [45](#)  
 status indicators [37](#)  
 storage humidity [287](#)  
 storage temperature [287](#)  
 STUN [130, 131](#)  
   settings [138](#)  
 STUN (Simple Traversal of User Datagram Protocol  
 (UDP) through Network Address Translators) [131](#)  
 subnet [299](#)  
 subnet mask [105, 300](#)  
 subnet-based bandwidth management [198](#)  
 subnets on the LAN [108](#)  
 subnetting [302](#)  
 supplementary phone services [141](#)  
 supplementary services  
   and DECT phones [150](#)  
 syntax conventions [4](#)  
 system name [253](#)  
 system timeout [210](#)

## T

TCP/IP port [230](#)  
 telephone keys, and DTMF [132](#)  
 text file format [323](#)  
 TFTP restrictions [209](#)  
 three-way conference [143, 144](#)  
 time  
   resetting [258](#)  
 ToS [133, 289](#)  
   and VoIP [134](#)  
 ToS (Type of Service) [133](#)  
 Touch Tone® [132](#)

trademarks [343](#)  
 traffic logs [261](#)  
 traffic redirect [103](#)  
 triangle route solutions [182](#)  
 trigger ports [118](#)  
 trigger ports example [118](#)  
 trigger ports process [118](#)  
 trigger ports setup [122](#)  
 trunking, VoIP [161](#)  
 Type Of Service, see ToS [133](#)  
 types of encapsulation [98](#)  
 types of models [33](#)

## U

Uniform Resource Identifier, see SIP URI [127](#)  
 Universal Plug and Play  
   application [217](#)  
   security issues [217](#)  
 Universal Plug and Play Forum [218](#)  
 Universal Plug and Play, see UPnP [217](#)  
 unused & unbudgeted bandwidth [200](#)  
 uploading firmware [274](#)  
 UPnP [227](#)  
   and auto-discovery [221](#)  
   and NAT [217](#)  
   certification [218](#)  
   installing example [218](#)  
   overview [217](#)  
   web configurator [227](#)  
 UPnP (Universal Plug and Play) [217](#)  
 USA type call service mode [143](#)  
 USB  
   and file sharing [243](#)  
   hard drive [243](#)  
   printer sharing [229](#)  
 USB features [35](#)  
 USB printer [35](#)  
 user agent, and SIP [128](#)  
 user authentication and WLAN [80](#)

## V

VAD [141, 289](#)  
   and silent packets [141](#)  
 VAD (Voice Activity Detection) [141](#)  
 Virtual Local Area Network, see VLAN [134](#)  
 VLAN [134](#)

- and VoIP [134, 139](#)
- VLAN (Virtual Local Area Network) [134](#)
- VLAN group [134](#)
- VLAN ID [134](#)
- VLAN ID tags [134](#)
- Voice Activity Detection, see VAD [141](#)
- voice coding [131](#)
- voice functions [289](#)
- voice mail [127](#)
- Voice over IP, see VoIP [127](#)
- VoIP [127](#)
  - advanced settings [135](#)
  - and codecs [131](#)
  - and DECT [150](#)
  - and echo cancellation [141](#)
  - and frequencies [132](#)
  - and NAT [130, 138](#)
  - and outbound proxy [131](#)
  - and PSTN [159](#)
  - and QoS [127, 133, 134, 139](#)
  - and required bandwidth [132](#)
  - and sound quality [131](#)
  - and the phone [141](#)
  - and ToS [134](#)
  - and VLAN [134, 139](#)
  - and web configurator [134](#)
  - overview [127](#)
  - peer-to-peer calls [157](#)
  - phone book [155](#)
  - wizard setup [57](#)
- VoIP and SIP [127](#)
- VoIP features [33](#)
- VoIP links [161](#)
- VoIP trunking [34, 161](#)
  - and security [161](#)
  - call rules [163](#)
  - detailed example [169, 170, 171, 172, 174](#)
  - examples [163, 164](#)
  - how it works [161](#)
  - overview [161](#)
  - peer authentication [166](#)
  - peer calls [165](#)
  - scenarios [163, 164](#)
  - SIP settings [164](#)
  - web configurator [164](#)

## W

- WAN [95](#)
  - advanced setup [102](#)
  - and backup gateway [104](#)
  - and cost of transmission [101](#)
  - and DNS [255](#)

- and encapsulation [98](#)
- and firewall [103](#)
- and heartbeat packets [97](#)
- and IGMP [103](#)
- and ISP [95, 97](#)
- and MAC address [96](#)
- and metric [101](#)
- and multicasting [103](#)
- and NetBIOS [103](#)
- and PPPoE [95, 99](#)
- and remote management [209](#)
- and traffic redirect [103](#)
- firewall [180](#)
- idle timeout [100](#)
- IP address [52, 95](#)
- nailed-up connection [100](#)
- overview [95](#)
- web configurator [97](#)
- WAN (Wide Area Network) [52](#)
- warranty [345](#)
  - note [345](#)
- waveform codec [131](#)
- web configurator [39](#)
  - and bandwidth management [203](#)
  - and DECT phone [150](#)
  - and LAN [110](#)
  - and NAT [119](#)
  - and PSTN [160](#)
  - and VoIP [134](#)
  - and VoIP trunking [164](#)
  - and WAN [97](#)
  - and WLAN [82](#)
  - default URL [39](#)
  - firewall [183](#)
  - navigation [42](#)
  - OTIST [89](#)
  - status bar [45](#)
  - wizard setup [47](#)
- weight [287](#)
- WEP encryption [85, 86](#)
- Wide Area Network, see WAN [95](#)
- Windows Explorer, and file sharing [247](#)
- wizard setup [47](#)
  - bandwidth management [60](#)
  - connection type [52](#)
  - connections [48](#)
  - DNS [53](#)
  - exceptions [48](#)
  - ISP [50](#)
  - main [48](#)
  - PPPoE [51, 54](#)
  - system information [49](#)
  - VoIP [57](#)
- WLAN
  - advanced settings [93](#)
  - and RADIUS [86](#)
  - and the RESET button [42](#)

- and WEP [81, 84](#)
- and WPA [81, 87](#)
- and WPA-PSK [81, 85](#)
- AP [79](#)
- channels [83](#)
- clients [89, 90](#)
- enabling [83](#)
- encryption [81](#)
- general settings [83](#)
- modes [93](#)
- overview [79](#)
- recommendation [81](#)
- security [80](#)
- selecting security [83](#)
- SSID [80](#)
- terms explained [82](#)
- web configurator [82](#)
- WLAN security
  - and encryption [81](#)
  - and IEEE 802.1x [80](#)
  - and SSID [80](#)
  - MAC address filter [80, 91](#)
  - OTIST [82, 88](#)
  - RADIUS [80, 86](#)
  - recommendation [81](#)
  - types of [81](#)
  - user authentication [80](#)
- workgroup, and file sharing [244, 248](#)
- WPA [87](#)
- WPA2
  - WPA compatible [81, 87](#)
- WPA-PSK
  - configuration [85](#)