

ZyXEL GS-3012 Series

(GS-3012/GS-3012F)

Ethernet Switch

Support Notes

Version 3.60

March 2006



INDEX[How to manage & maintain your Switch?](#)

- Firmware Upgrade**
- Restore a Configuration File**
- Backing Up a Configuration File**
- Load Factory Defaults**

[Physical Switch connection](#)

- Connecting two switches via Fiber Channel**

[General Networking](#)

- DHCP option 82 (Relay Agent Information Option)**

[Separating a physical network into many virtual networks](#)

- Introduction to Virtual LAN**
- Port Based Virtual LAN**
- Setting up Port Based VLAN**
- IEEE 802.1Q Tag-based VLAN**
- Setting up Tag-based VLAN**

[IP Multicasting](#)

- IGMP Snooping**
- Multicast VLAN Registration (MVR)**

[To ring a network by building redundant links and connections between Switch](#)

- Introduction to Spanning Tree Protocol**
- How does Spanning Tree Protocol Work?**

[Switching security](#)

- MAC freeze**
- Classifier & Policy Rule (ACL)**

[Centralized Management](#)

- Introduction of SNMPc and NetAtlas**
- *NetAtlas v1.03 and newer releases will support GS-3012 Series**
- Cluster Management -- iStacking**
- Remote Monitoring (RMON)**

[FAQ](#)

- What is the default setting of the IP parameters?**
- What is the default login Name and Password of the Web Configuration?**
- How to access the Switch through the console port?**
- What is default login password of the console, telnet, and FTP?**
- How to change the password?**
- How to access the Command Line Interface?**
- If I forgot the Switch password, how can I reset the password to default?**

How do I configure an IP address?

Is Online Help available on the Web GUI?

How to restart device from Web?

How to check the current running firmware version?

Is the mini GBIC transceiver hot-swappable?

What is so called "Dual-Personality interface" in Ethernet Switching?

Remaining:

Some demonstration in this support note may not use the exact model that you are using. However, their functions and settings work the same way.

How to manage & maintain your Switch?

Firmware Upgrade

From Web GUI:

1. Download (and unzipped) the correct model firmware to your computer.
2. Click Management and then Maintenance in the navigator panel to bring up the following screen.

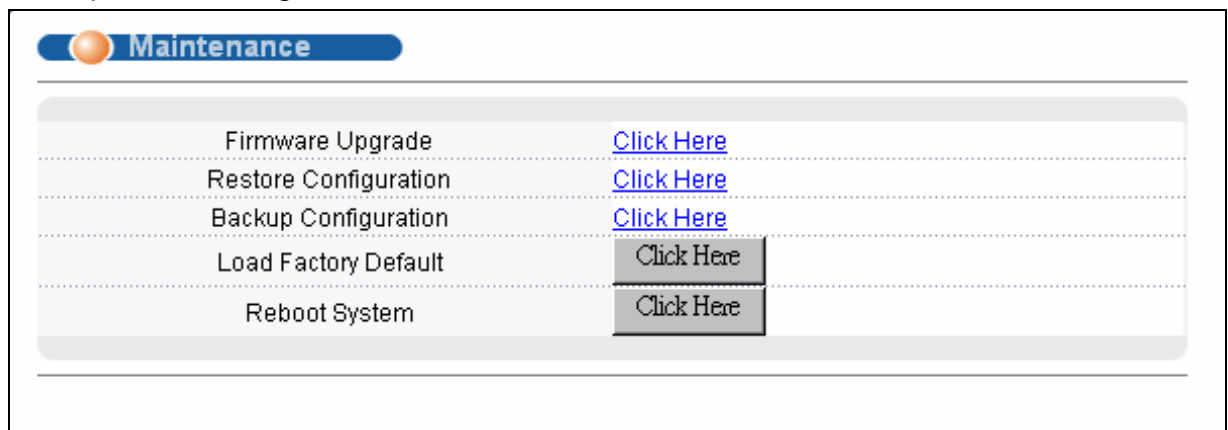

3. Click on the "Click Here" link of the Firmware Upgrade to bring up the following screen.

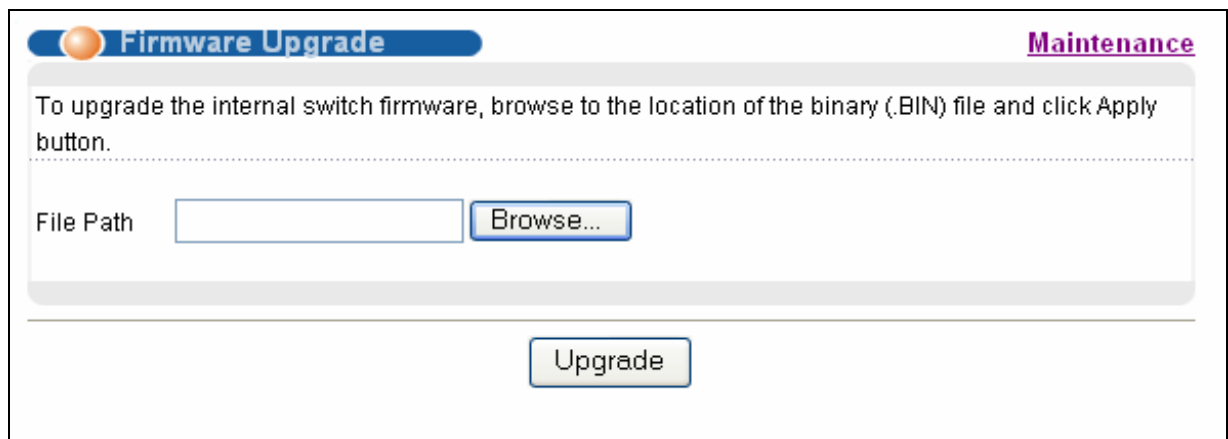

4. Browse the firmware located or type in the path into the "File Path" field.
5. Click on the Upgrade button.

From Console Port:

1. Download (and unzipped) the correct model firmware to your computer.
2. Connect to the console port and open the Terminal Emulation Software.
3. Restarting the switch to enter the debug mode via the terminal.
4. Enter "ATUR".
5. Use X-modem protocol to transfer (Send File) the firmware.
6. Enter "ATGO" to restart the switch after done uploading the firmware.

From Command Line FTP:

1. Download (and unzipped) the correct model firmware to your computer.
2. Launch the FTP client on your PC to login to Switch. (From the command prompt, type "ftp <Switch IP>")
3. Press "Enter" for the User name
4. Enter password to get the ftp prompt.
5. Enter "bin" to set transfer mode to binary.
6. Use "put" to transfer the firmware from the computer to the switch, for example: "put firmware.bin ras" transfers the firmware on your computer (firmware.bin) to the switch and renames it "ras".
7. Enter "quit" to exit the ftp prompt.

Restore a Configuration File

From Web GUI:

1. Click Management and then Maintenance in the navigator panel to bring up the following screen.

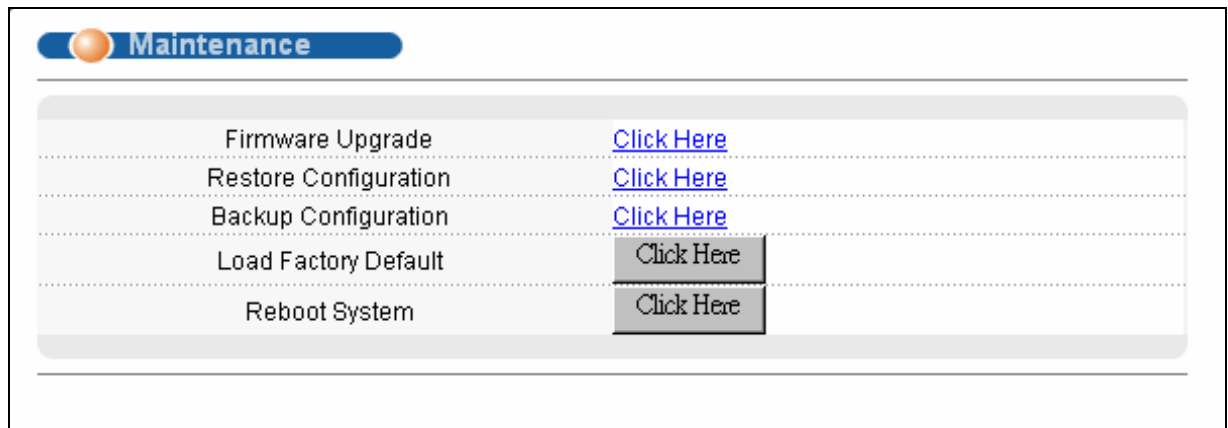

2. Click on the "Click Here" link of the Restore Configuration to bring up the following screen.

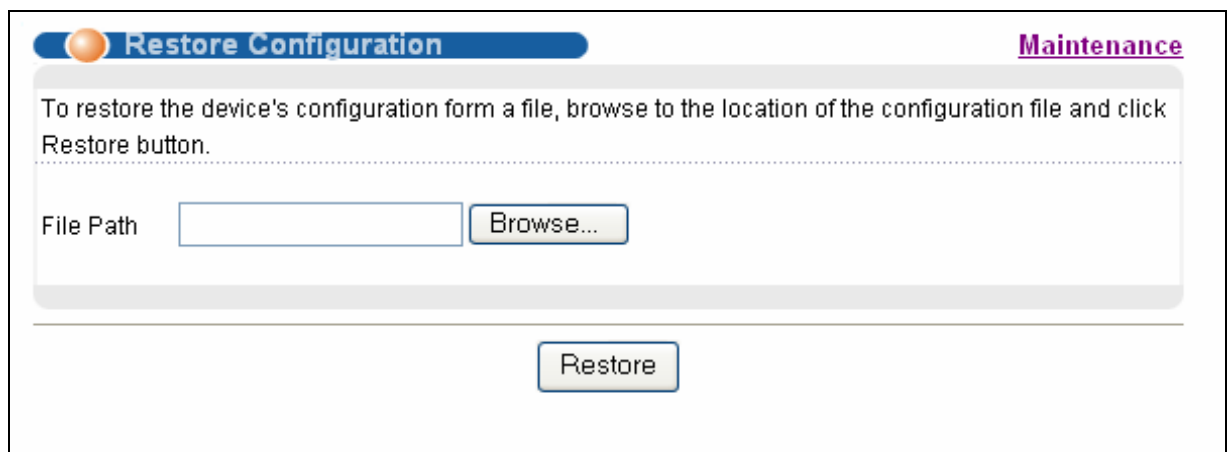

3. Browse to locate the file with the file name or type in the path and the file name into the "File Path" field.
4. Click on the Restore button.

From Console Port:

1. Connect to the console port and open the Terminal Emulation Software.

2. Restarting the Switch to enter the debug mode via the terminal.
3. Enter "ATLC"
4. Use X-modem protocol to transfer (Send File) the firmware.
5. Enter "ATGO" to restart the Switch after done uploading the configuration file.

From Command Line FTP:

1. Download (and unzipped) the correct model firmware to your computer.
2. Launch the FTP client on your PC to login to Switch. (From the command prompt, type "ftp <Switch IP>".
3. Press "Enter" for the User name
4. Enter password to get the ftp prompt.
5. Enter "bin" to set transfer mode to binary.
6. Use "put" to transfer the the configuration file from the computer to the switch, for example: "put comfig.rom rom-0" transfers the firmware on your computer (config.rom) to the switch and renames it "rom-0".
7. Enter "quit" to exit the ftp prompt.

Backing Up a Configuration File

From Web GUI:

1. Click Management and then Maintenance in the navigator panel to bring up the following screen.

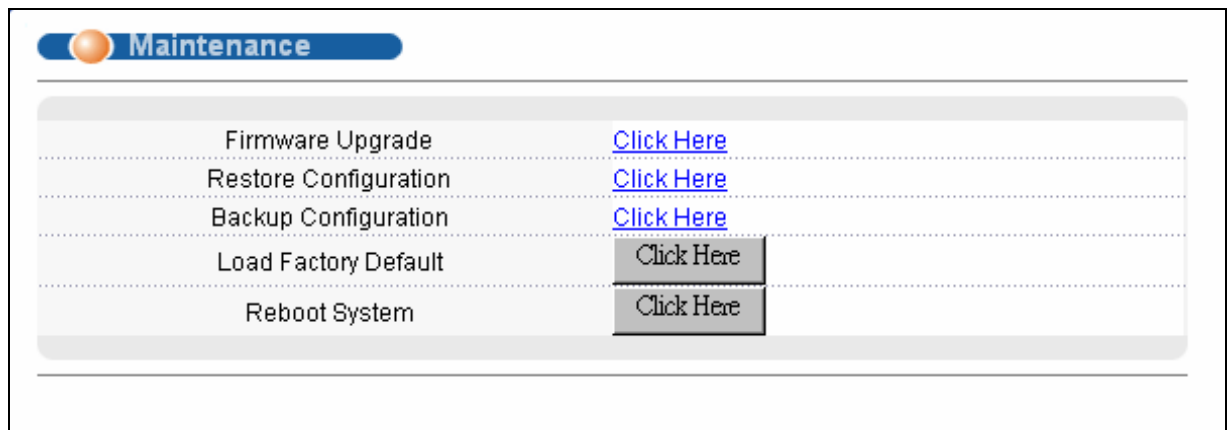

2. Click on the "Click Here" link of the Backup Configuration to bring up the following screen.

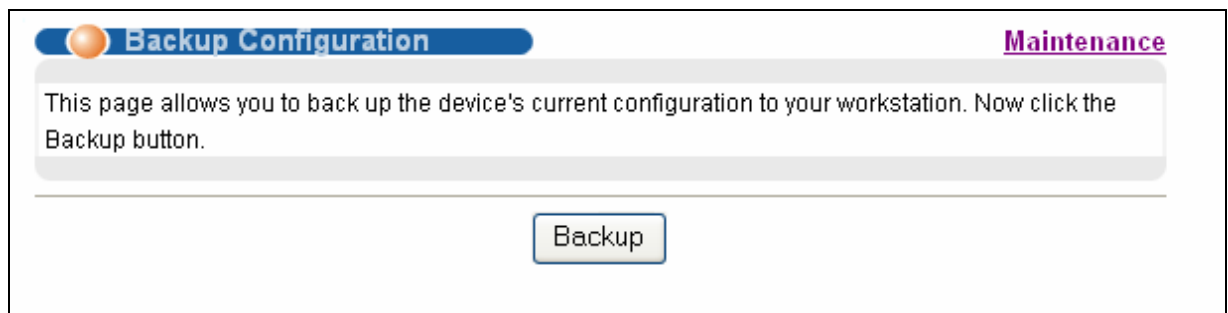

3. Click on the "Backup" button to bring up the File Download dialog. Then, clicking on the Save button to backup the configuration rom file to a proper location.

From Console Port:

1. Connect to the console port and open the Terminal Emulation Software.
2. Restarting the Switch to enter the debug mode via the terminal.
3. Enter "ATTD"

4. Use X-modem protocol to transfer (Receive File) the firmware.
5. Enter "ATGO" to restart the Switch after done uploading the configuration file.

From Command Line FTP:

1. Download (and unzipped) the correct model firmware to your computer.
2. Launch the FTP client on your PC to login Switch. (From the command prompt, type "ftp <Switch IP>")
3. Press "Enter" for the User name
4. Enter password to get the ftp prompt.
5. Enter "bin" to set transfer mode to binary.
6. Use "get" to transfer the firmware from the computer to the switch, for example: "get rom-0 config.rom" transfers the firmware on your computer (config.rom) to the switch and renames it "config.rom".
7. Enter "quit" to exit the ftp prompt.

Load Factory Defaults

From Web GUI:

1. Click Management and then Maintenance in the navigator panel to bring up the following screen.

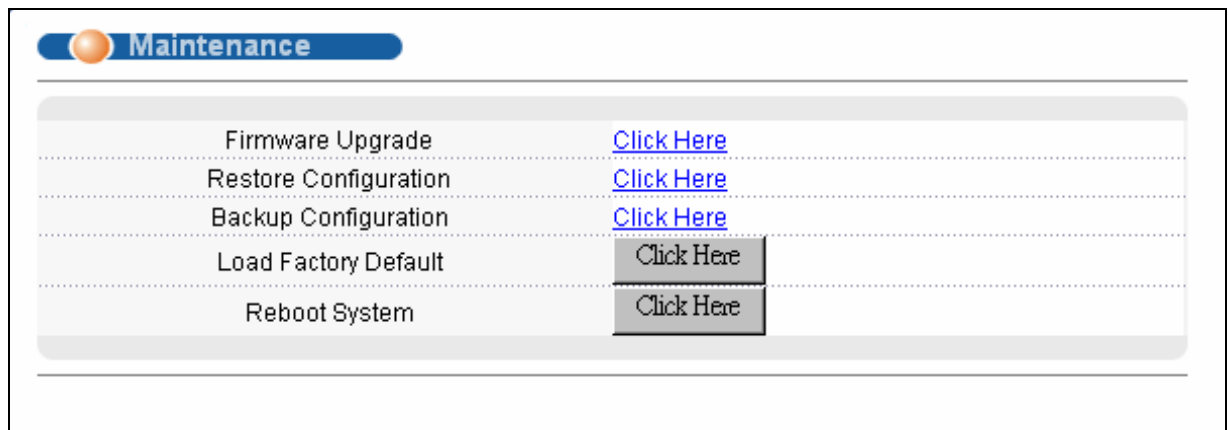

2. Click on the “Click Here” button of the Load Factory Defaults to bring up the following screen.
3. A dialog pops up with the message “Are you sure you want to load factory defaults?”.

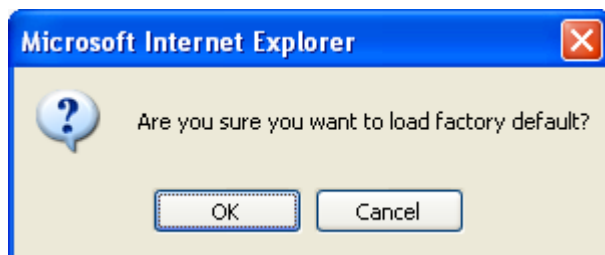

4. Click OK to go to the following dialog.
5. Click on the OK button. Now, all switch configurations has been reset to the factory defaults and the system will be restarted.
6. Please note that the switch IP address is now 192.168.1.1.

From Console Port:

1. Connect to the console port and open the Terminal Emulation Software.
2. Type in the correct password to bring up the prompt.
Type “erase run” to load the factory default configurations.

Physical Switch connection

How to connect two switches via Fiber Channel

Your Switch may come with one or many mini-GB ports. ZyXEL offers Small Form-factor Pluggable (SFP) transceivers for Gigabit Ethernet and Fiber Channel applications. These small, modular optical interface transceivers offer a convenient and cost effective solution for the adoption of Gigabit Ethernet and Fiber Channel in data center, campus, metropolitan area access, ring networks, and storage area networks. It supports full duplex Gigabit speeds and hot-pluggable feature.

Scenario

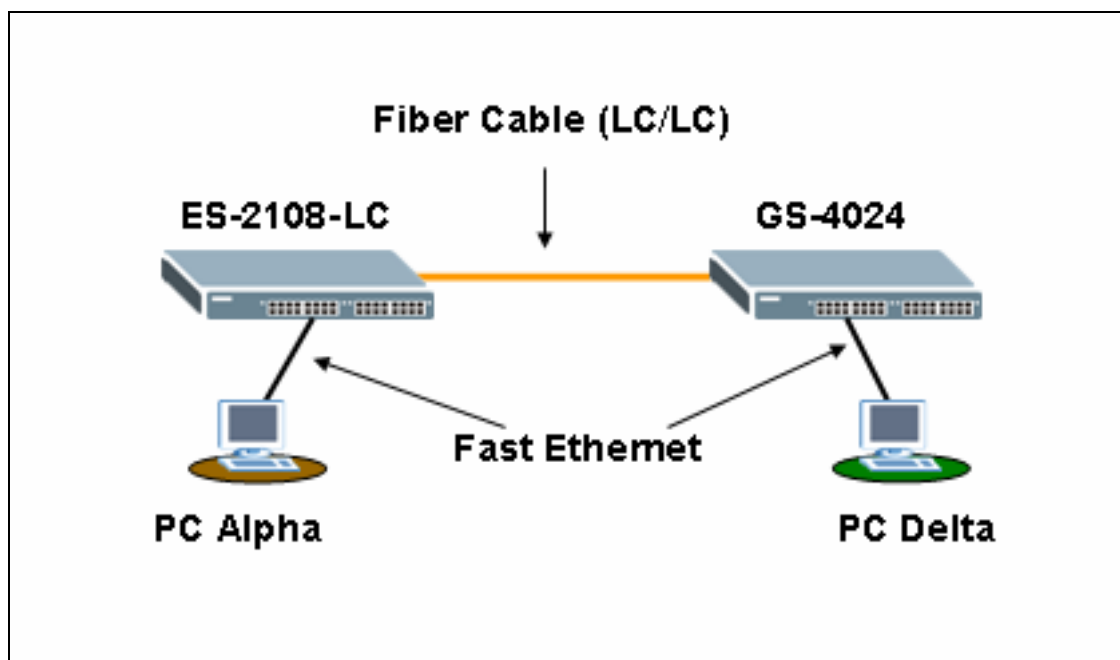

In this scenario, ES-2108-LC is connected to GS-4024 via the mini-GB Port with a LC/LC Fiber cable (62.5/125MM). PC "Alpha" is connected to ES-2108-LC and another PC "Delta" is connected to the GS-4024 Switch via the RJ45 Port.

What you need here to complete this scenario:

- ZyXEL Switch with Mini-GB port x2
(note: Each GS-3012 comes with 4 Mini-GB Port)
- SFP-SX Transceiver x2
- LC/LC Fiber Cable (62.5/125MM) x1

Here is the photo of the SFP-SX Transceiver & the LC/LC Fiber Cable.

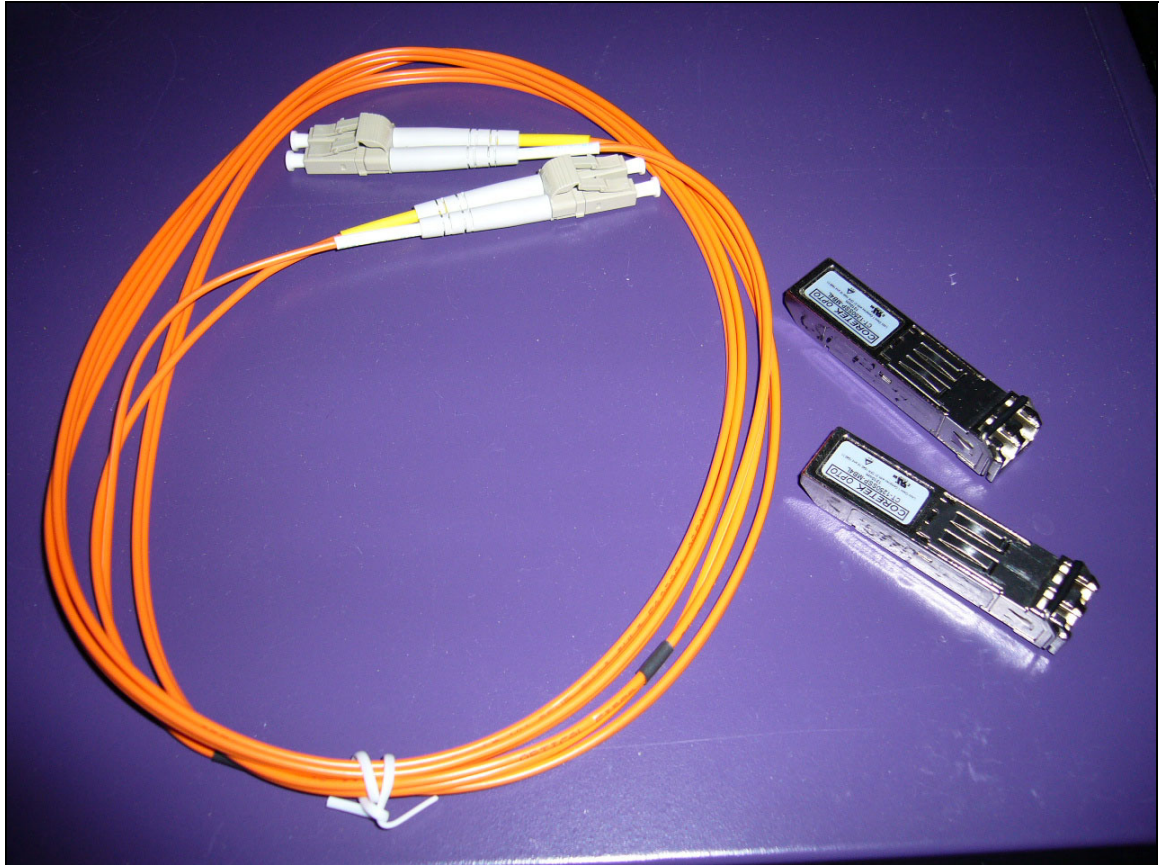

Steps to complete this scenario

1. First, pick up your ES-2108-LC and GS-4024Switch and power them up.

Photo of the ES-2108-LC Switch



2. Find both Mini-GB Port on ES-2108-LC and GS-4024.

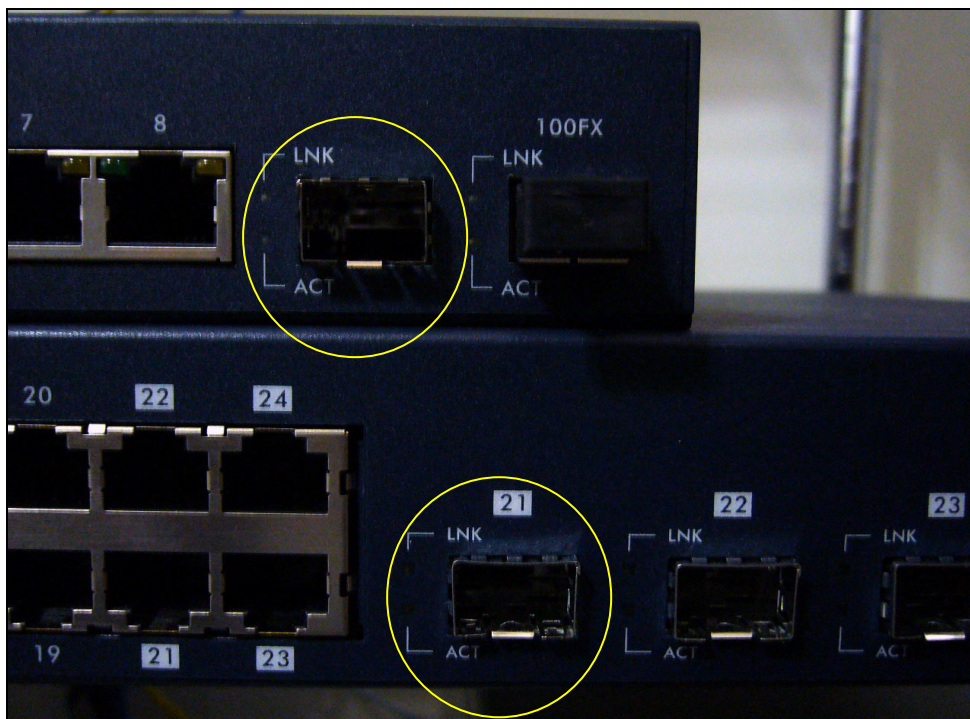

3. Get one transceiver and plug it into the Mini-GB Port of ES-2108-LC

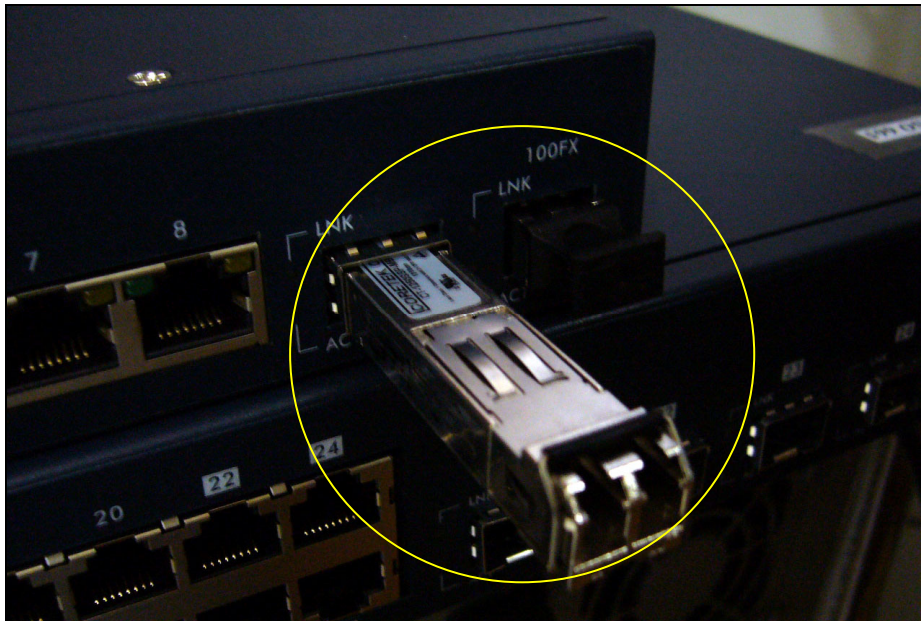

4. Plug another transceiver into the Mini-GB Port of GS-4024 Switch

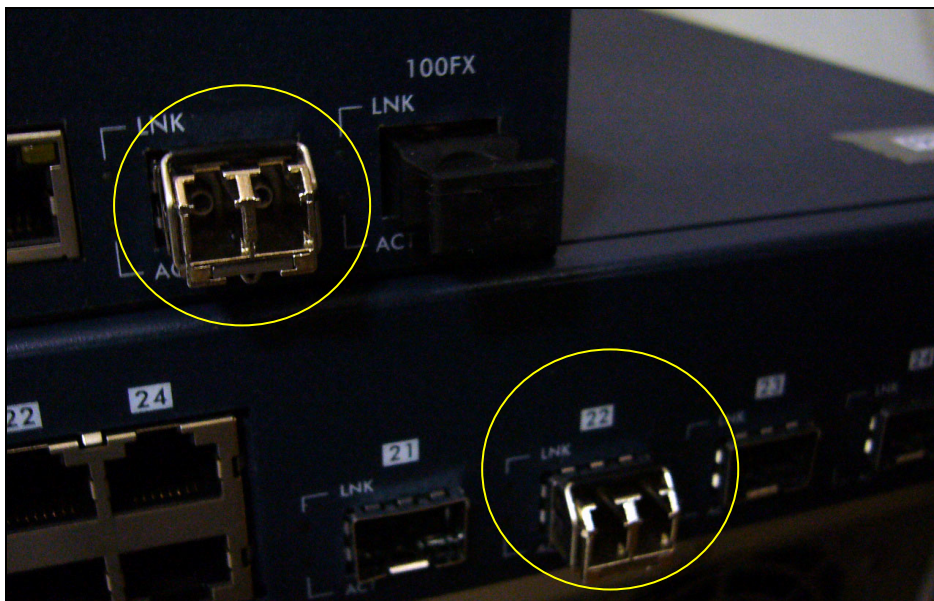

5. Remove both side of the protection cap from the LC/LC Fiber Cable.

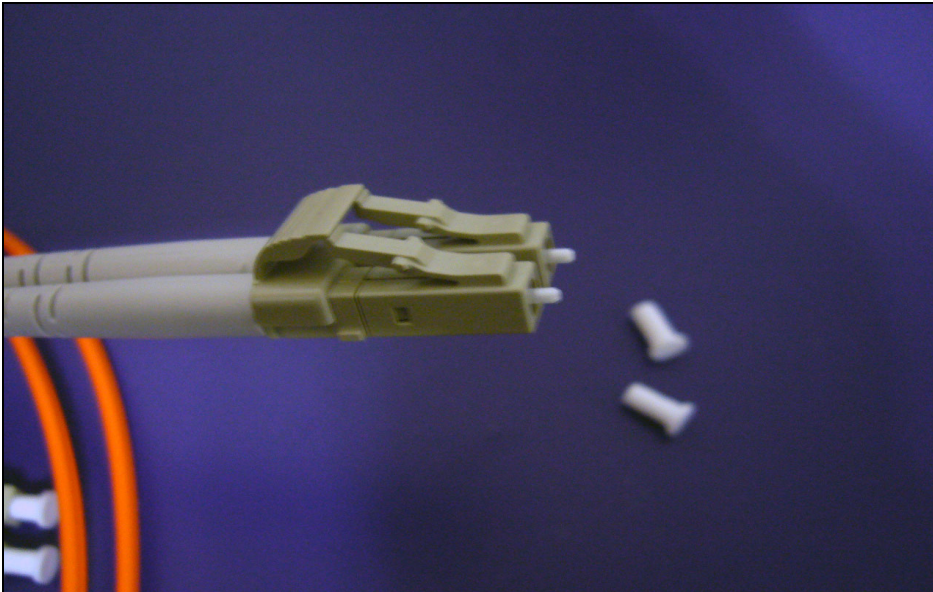

6. Plug the LC/LC Fiber Cable into the transceivers on both ES-2108-LC and GS-4024 Switch.

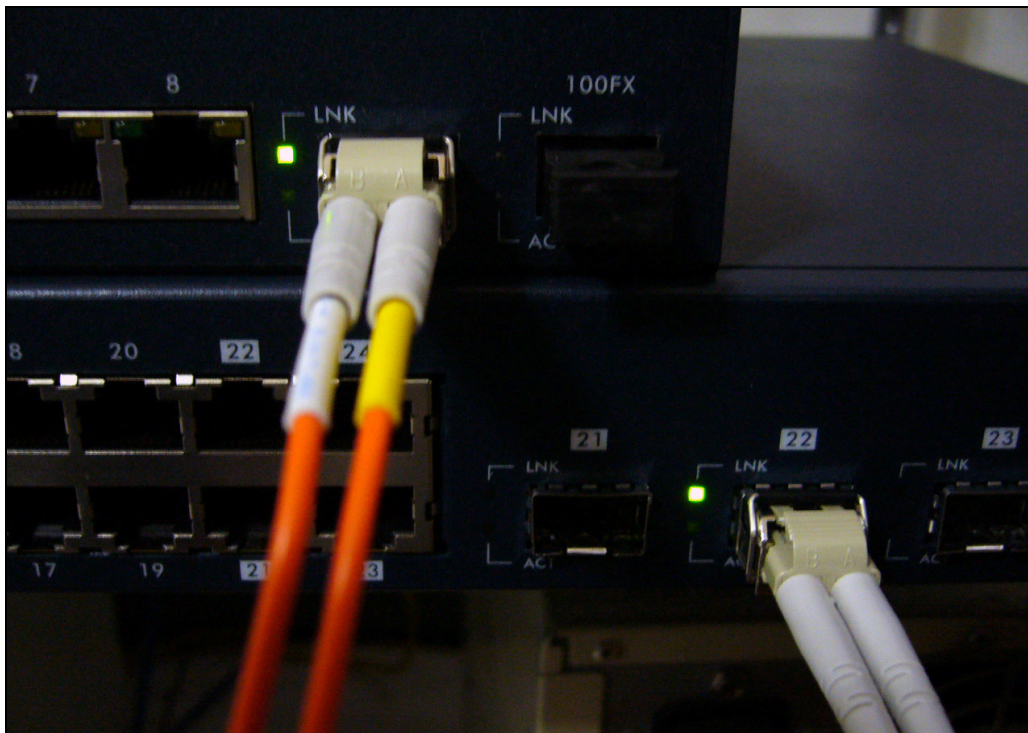

If you connected the cable correctly, the LED of the “LINK” will light up.

7. Now, connect the first PC “Alpha” to ES-2108-LC and the second PC “Delta” to the GS-4024 via the regular Ethernet cable.
8. Set the NICs in both computers to the same IP Domain.
(ex, PC “Alpha” :192.168.1.4/24; PC “Delta” : 192.168.1.5/24)
9. From PC “Alpha”, PING PC “Delta” at 192.168.1.5

```
C:\>ping 192.168.1.5

Pinging 192.168.1.5 with 32 bytes of data:

Reply from 192.168.1.5: bytes=32 time=10ms TTL=254
Reply from 192.168.1.5: bytes=32 time=5ms TTL=254
Reply from 192.168.1.5: bytes=32 time=5ms TTL=254
Reply from 192.168.1.5: bytes=32 time=6ms TTL=254

Ping statistics for 192.168.1.5:
    Packets: Sent = 4, Received = 4, Lost = 0 (0% loss),
    Approximate round trip times in milli-seconds:
        Minimum = 5ms, Maximum = 10ms, Average = 6ms
```

10. From PC “Delta”, PING PC “Alpha” at 192.168.1.4

```
C:\>ping 192.168.1.4

Pinging 192.168.1.4 with 32 bytes of data:

Reply from 192.168.1.4: bytes=32 time=5ms TTL=254
Reply from 192.168.1.4: bytes=32 time=9ms TTL=254
Reply from 192.168.1.4: bytes=32 time=5ms TTL=254
Reply from 192.168.1.4: bytes=32 time=28ms TTL=254

Ping statistics for 192.168.1.4:
    Packets: Sent = 4, Received = 4, Lost = 0 (0% loss),
    Approximate round trip times in milli-seconds:
        Minimum = 5ms, Maximum = 28ms, Average = 11ms
```

11. Now you can confirm that the network connection between ES-2108-LC and GS-4024 is up and running.

General Networking

DHCP Relay Option 82 Application

ISP may want to limit the number of IP address or deliver some specific IP addresses according to certain Switch port, VLAN ID and option 82 string. They can easily to achieve this with DHCP Relay Option 82 feature and a DHCP server supporting Option 82 function.

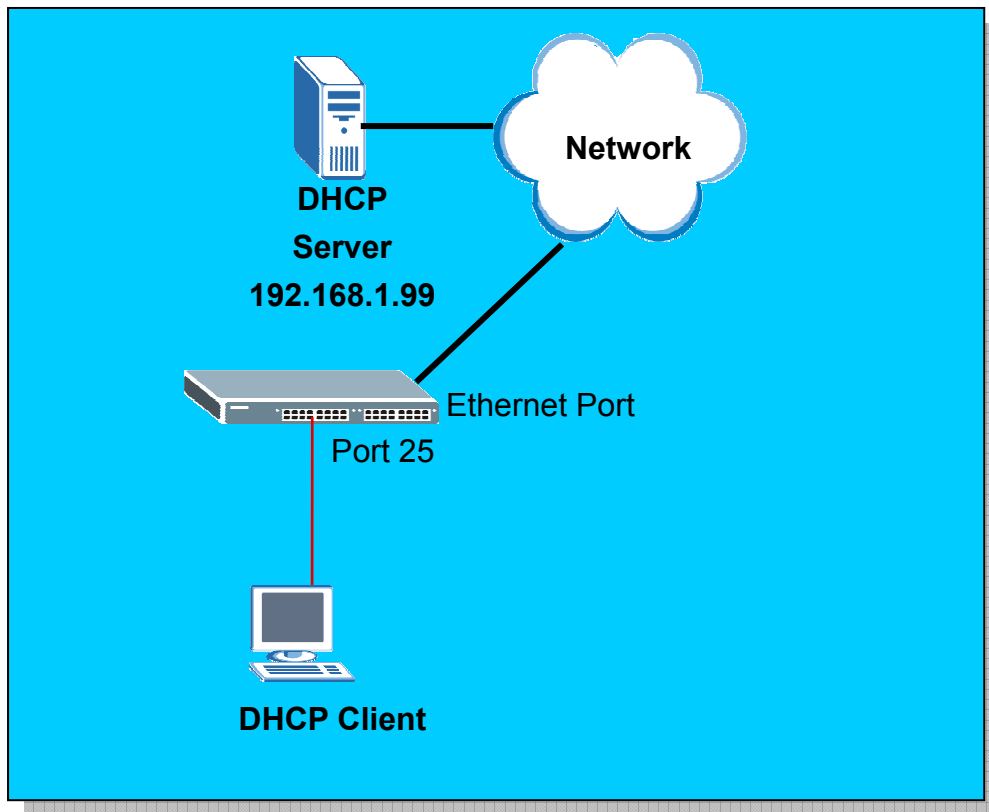

How to set up DHCP Relay Option 82 Environment

Here, we will set up an environment to allow a PC to get DHCP IP address in specific IP pool according to its Switch port, VLAN ID and the option 82 string. In this case, the PC is behind 25th Switch port and the option 82 string is a string "GS-3012". We use the IP Commander as DHCP server. Its IP is 192.168.1.99 and the IP pool is between 192.168.1.201 and 192.168.1.203 for VID=1, Switch port=25 and the option 82 string is "GS-3012".

1. Switch (GS-3012) settings

Click **IP Application**, **DHCP Relay** in the navigation panel to display configuration screen as shown. You will see the **DHCP Relay** setup page. Active the DHCP relay and Option 82 function. Also, click **Information** to make "GS-3012" as the Option 82 string. **Information** is READ ONLY here and it is the same as the host name of the Switch.

DHCP Relay	
Active	<input checked="" type="checkbox"/>
Remote DHCP Server 1	192.168.1.99
Remote DHCP Server 2	0.0.0.0
Remote DHCP Server 3	0.0.0.0
Relay Agent Information	<input checked="" type="checkbox"/> Option 82
Information	<input type="text" value="GS-3012"/>

Apply Cancel

Now we can connect PC to the 25th SWITCH port. Please see former applications for detailed settings.

3. IP Commander settings

Open IP Commander. Right click "IP commander and then click "connect new server".

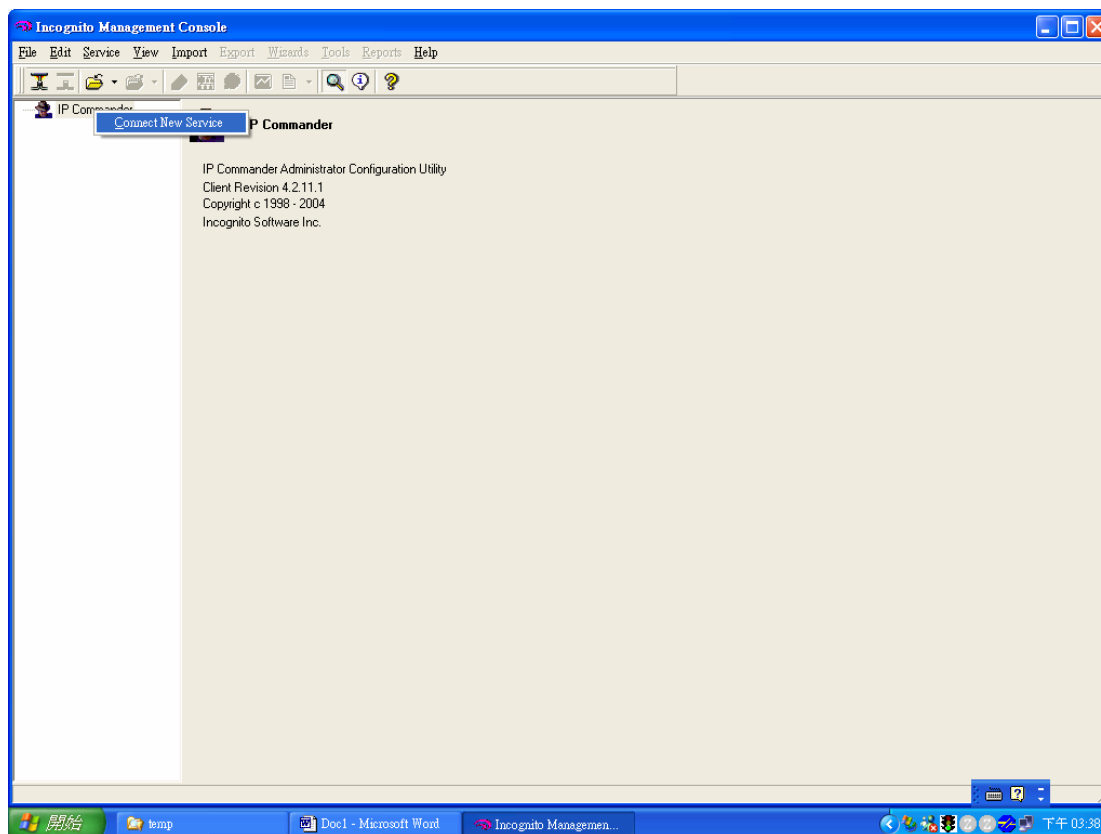

Input the DHCP IP address or domain name and click "ok". Our IP is 192.168.1.99.

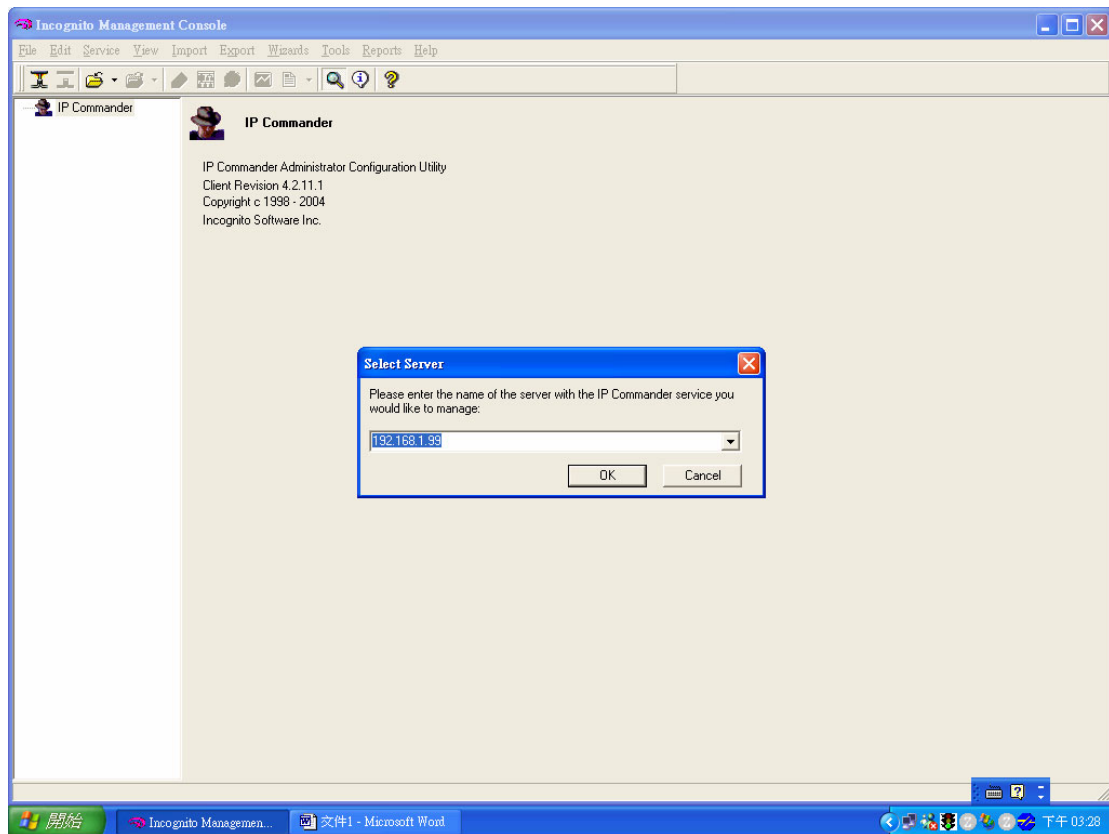

Input user name and password. The default user name is “administrator” and password is “incognito”.

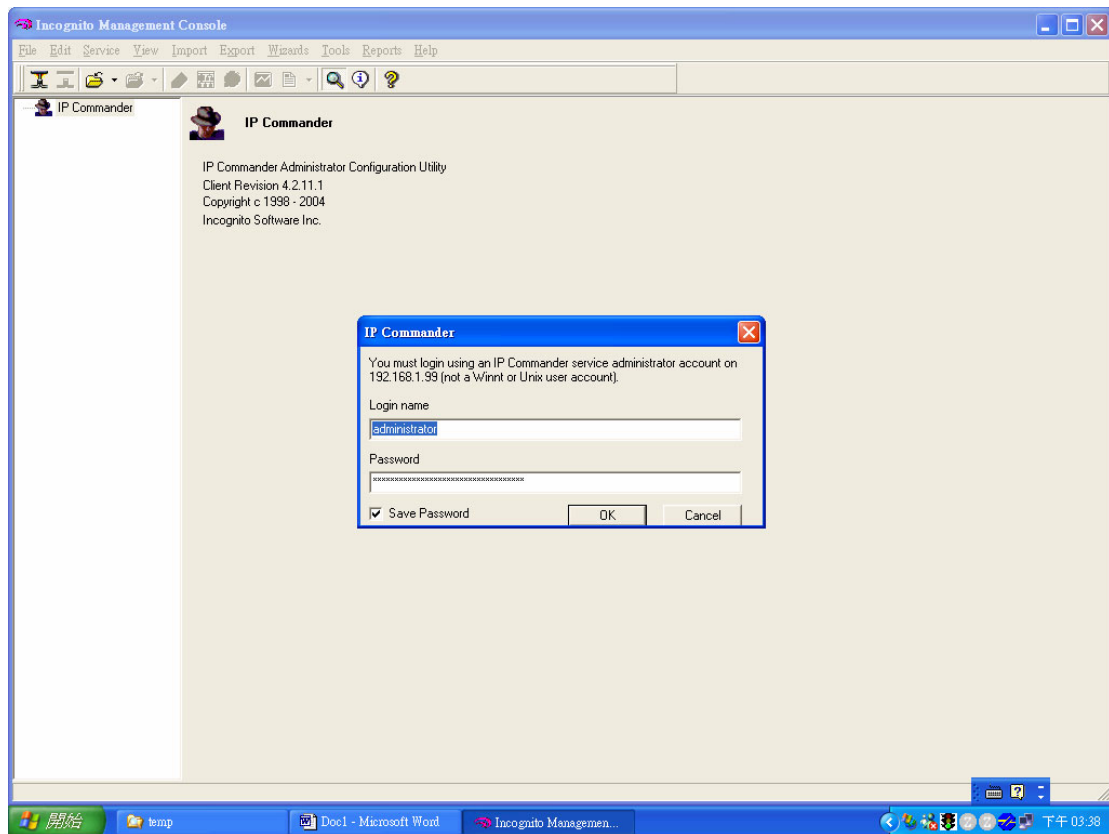

It will bring up the following screen, please make sure that your DHCP is in “online” status. Then click “wizard” in the top tool bars and select “rule wizard”.

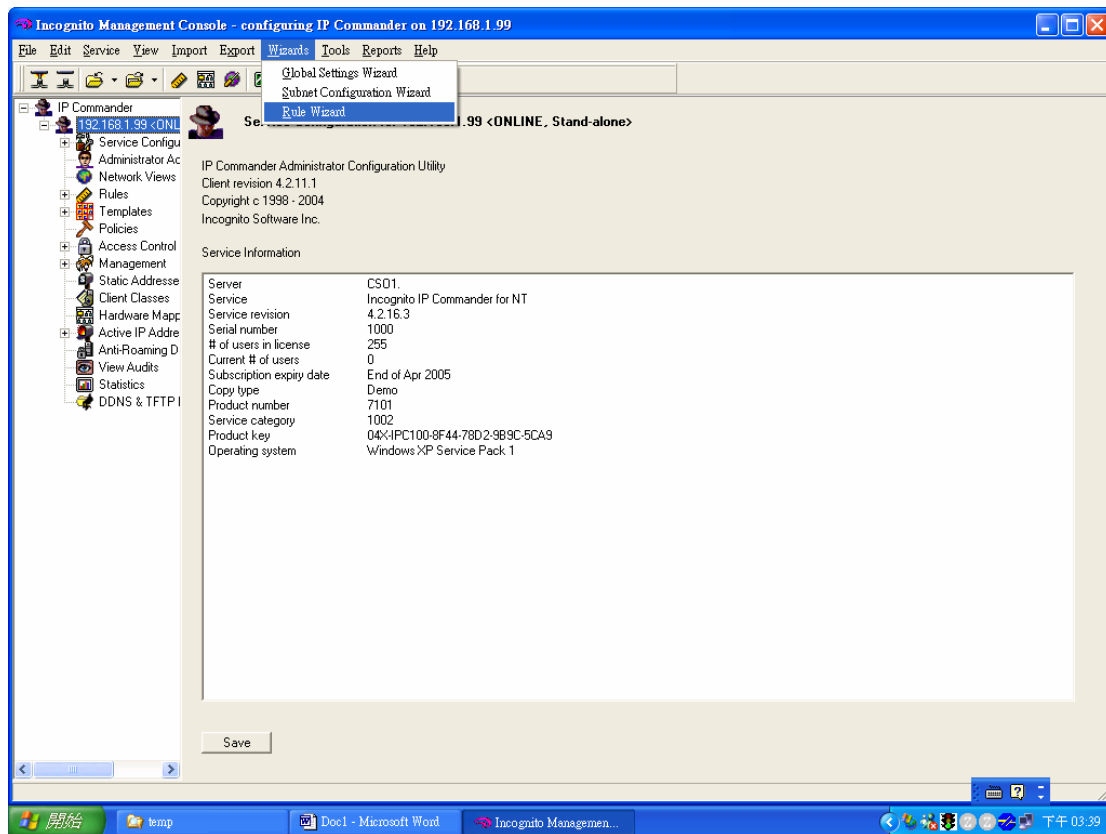

Give a name and description to the new rule.

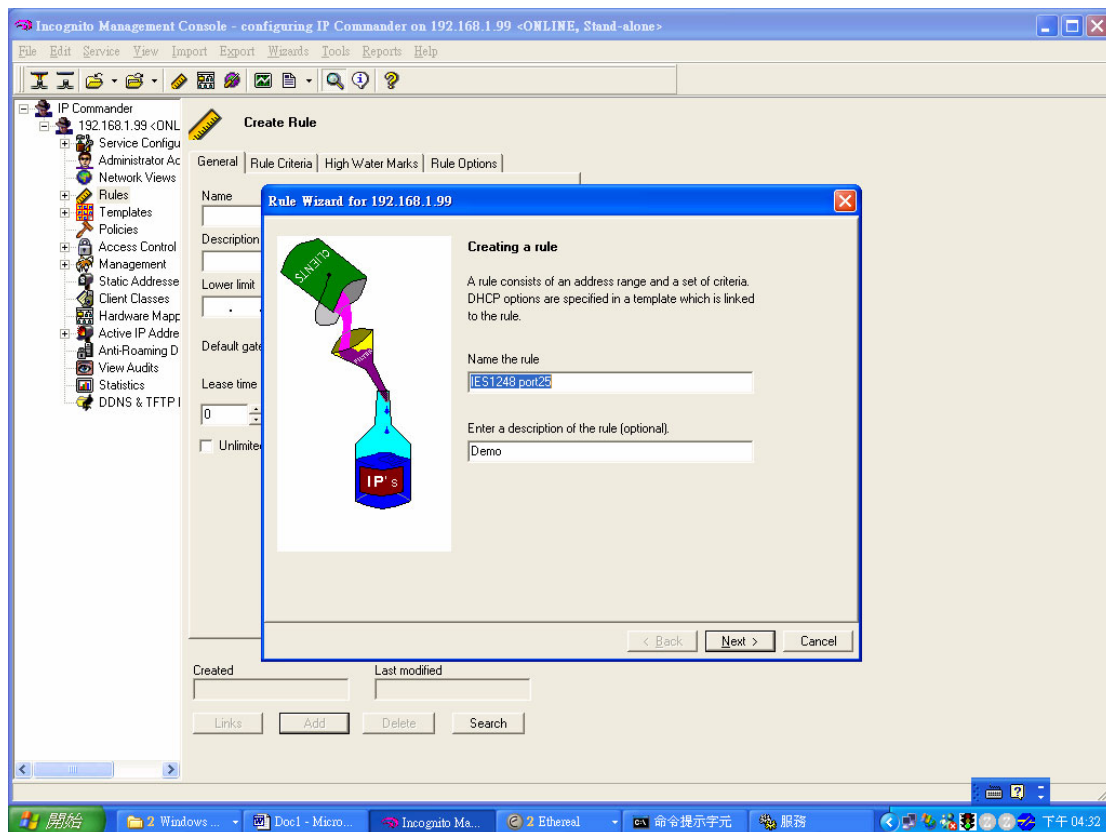

Assign a range of IP addresses or just one IP address to this rule. In our case, we set the IP pool from 192.168.1.201 to 192.168.1.203.

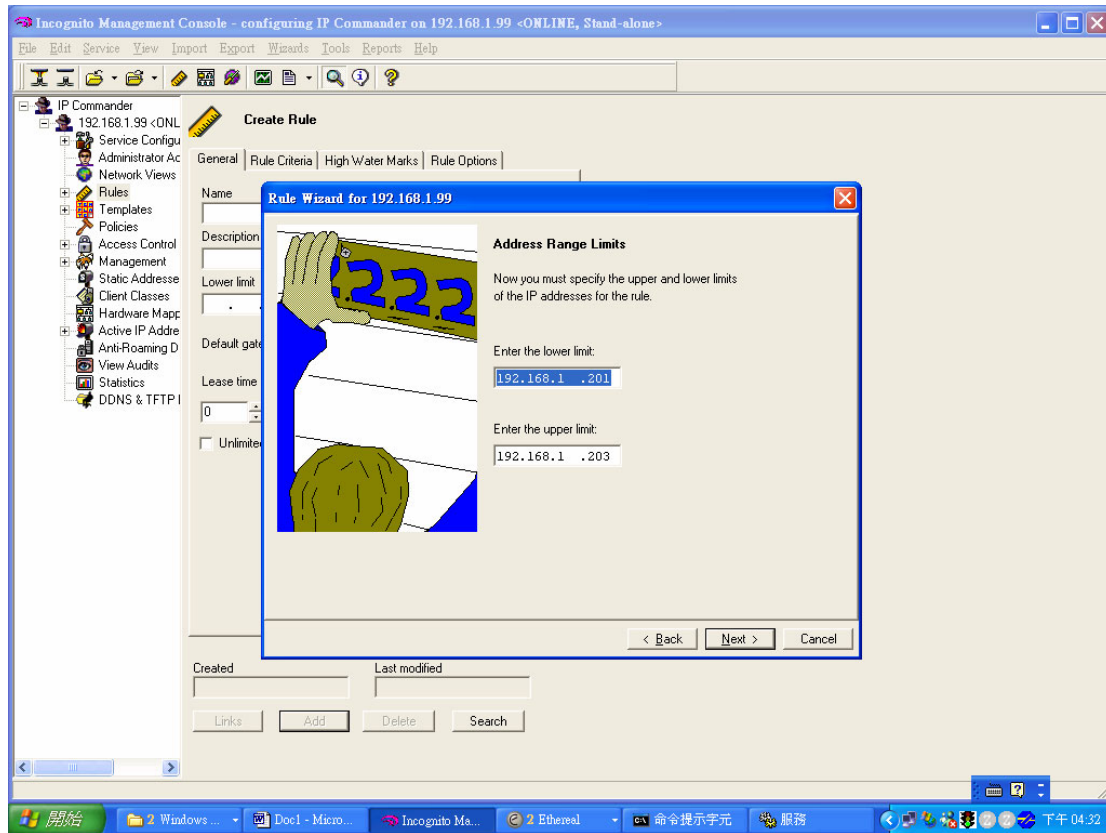

After input IP pool, we select “DHCP Option” in Keywords combobox.

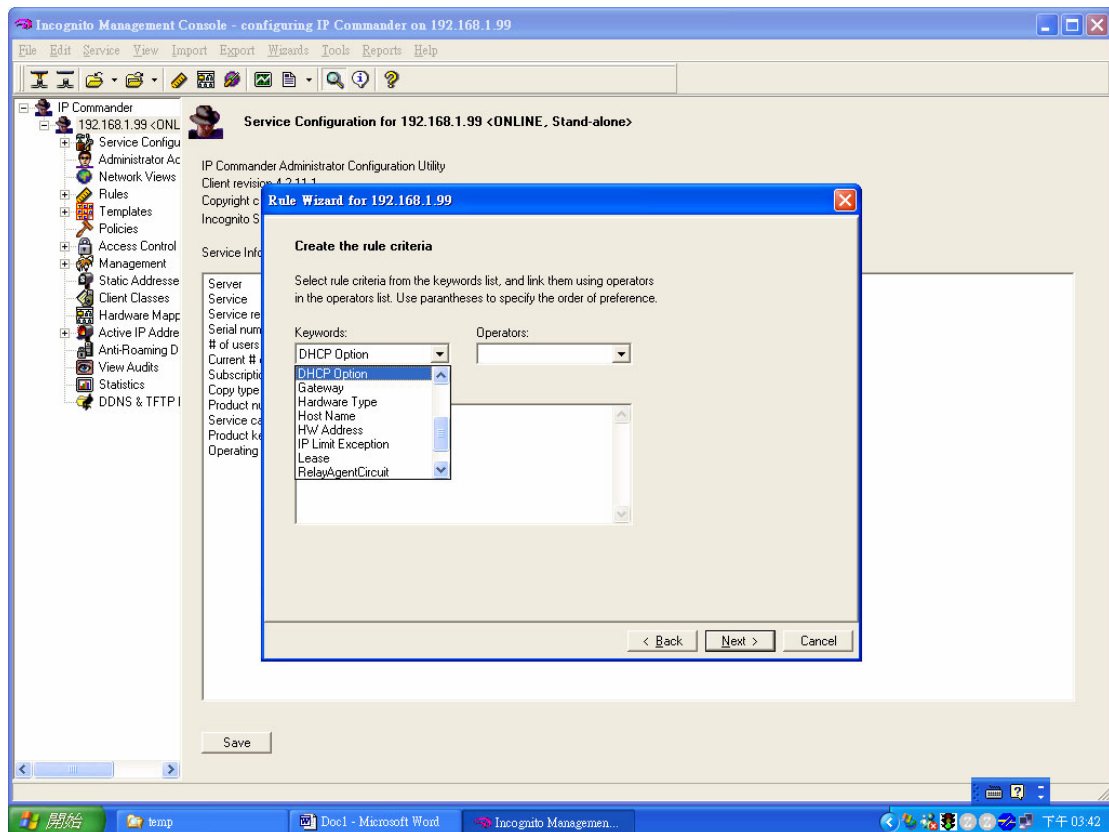

After select the “DHCP Option”, it will pop up “Add DHCP Option Rule” dialog. Select “option 82 Relay Agent Information”, sub-option 1, binary data. For port 25, VLAN 1, “GS-3012”, please key in “0019000147532d33303132” as the key value and click OK. Please note that the first 2 bytes define port number, the second 2 bytes is VLAN ID and the other bytes are the Option 82 string.

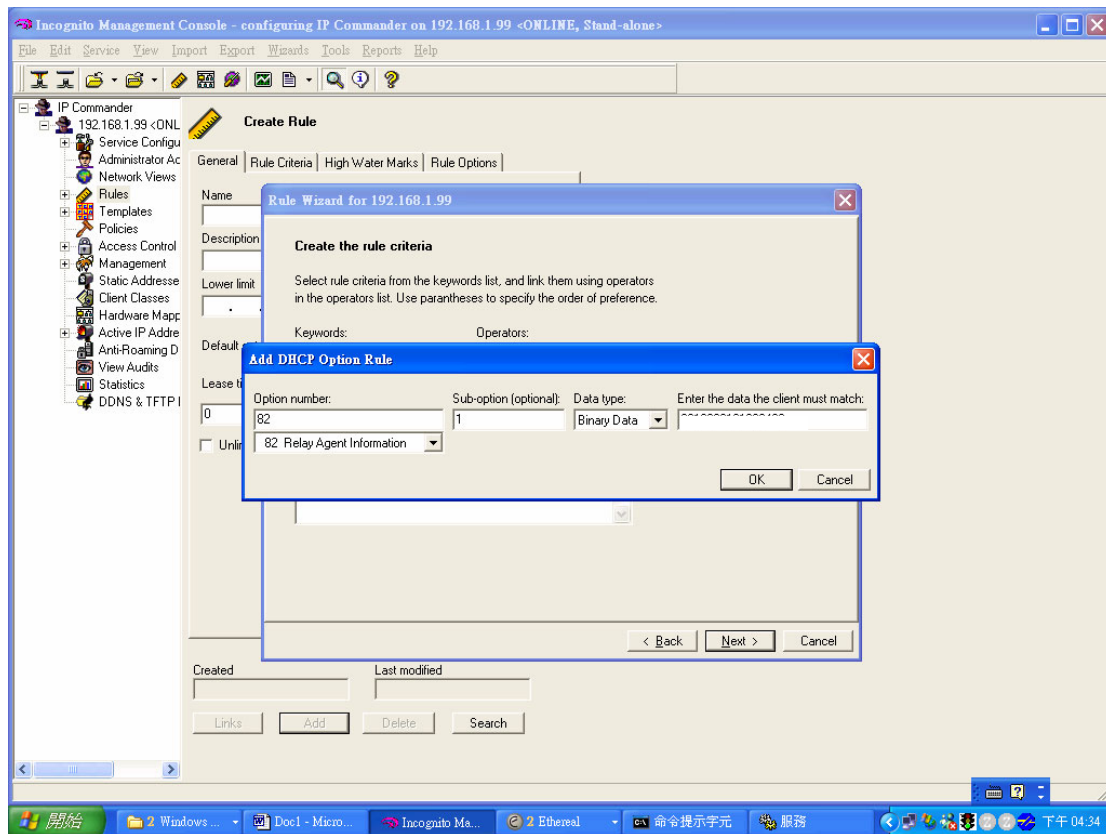

After you finish above step, you will see the following figure.

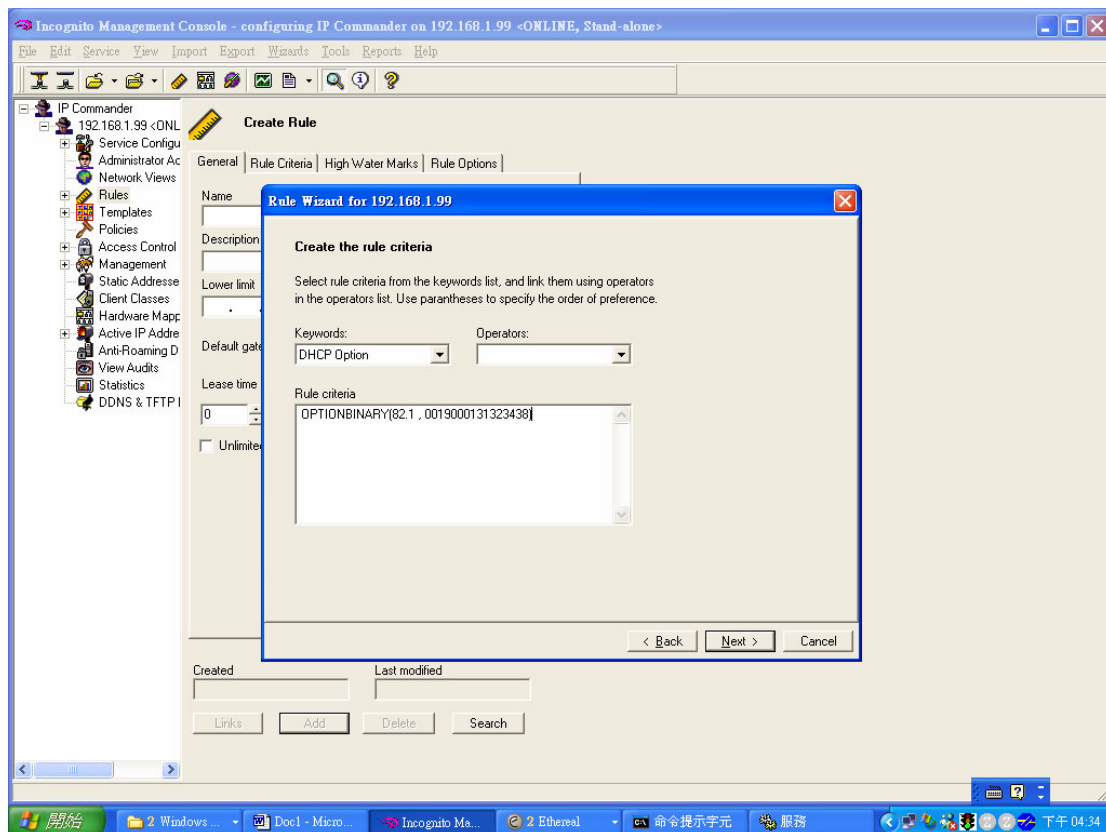

Then pop up the following screen and you can just press **Next** button.

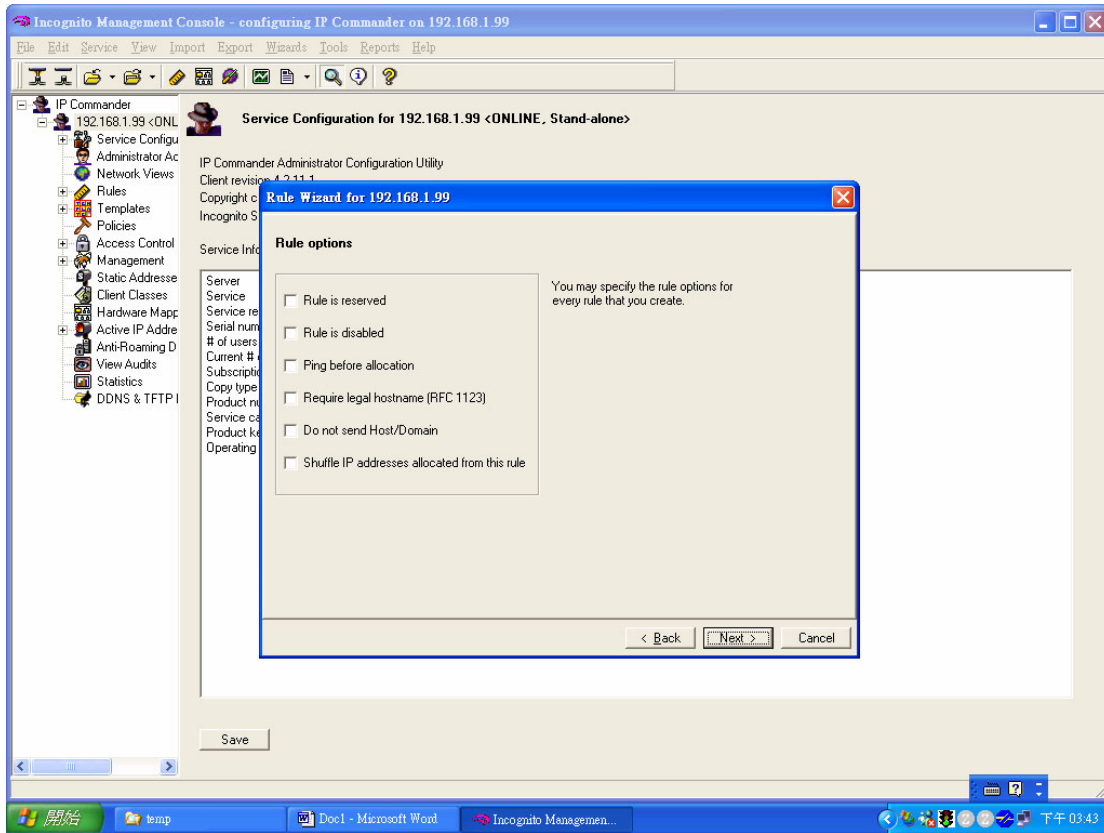

Then you can add DHCP template (option) such as gateway, DNS server and so on.

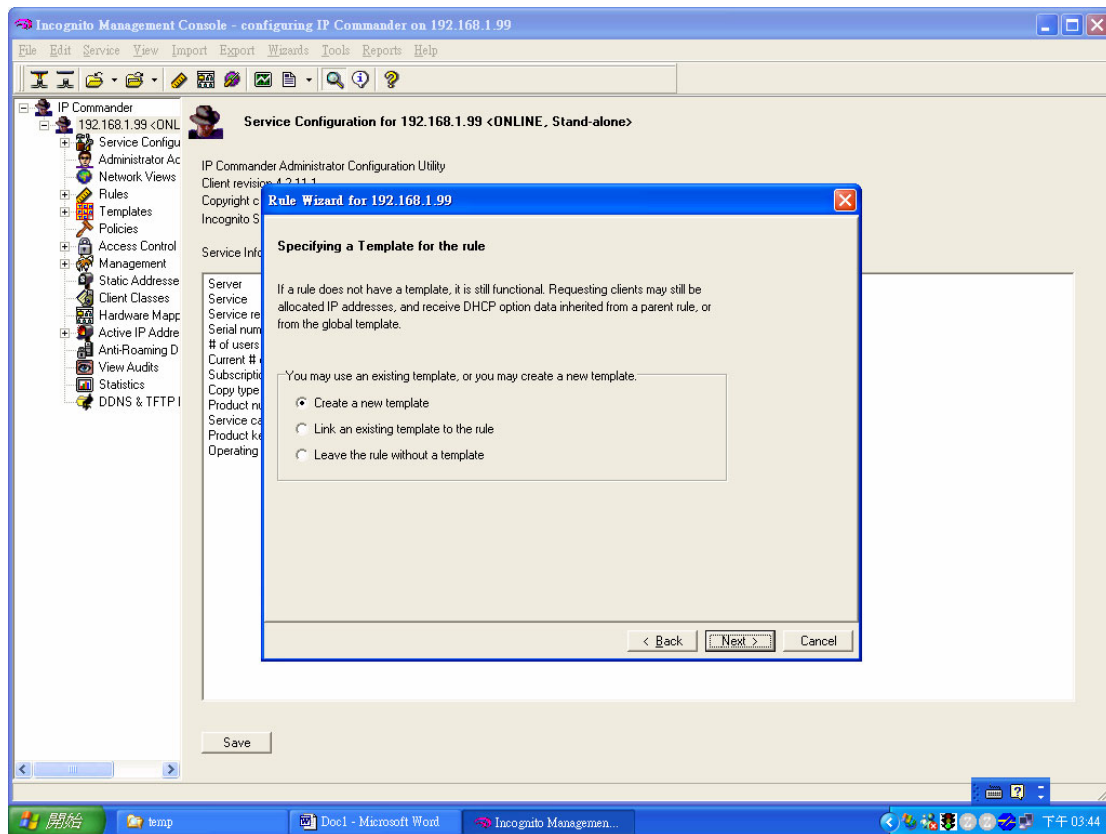

Here we use "192.168.1.1" as gateway IP address of DHCP client PC.

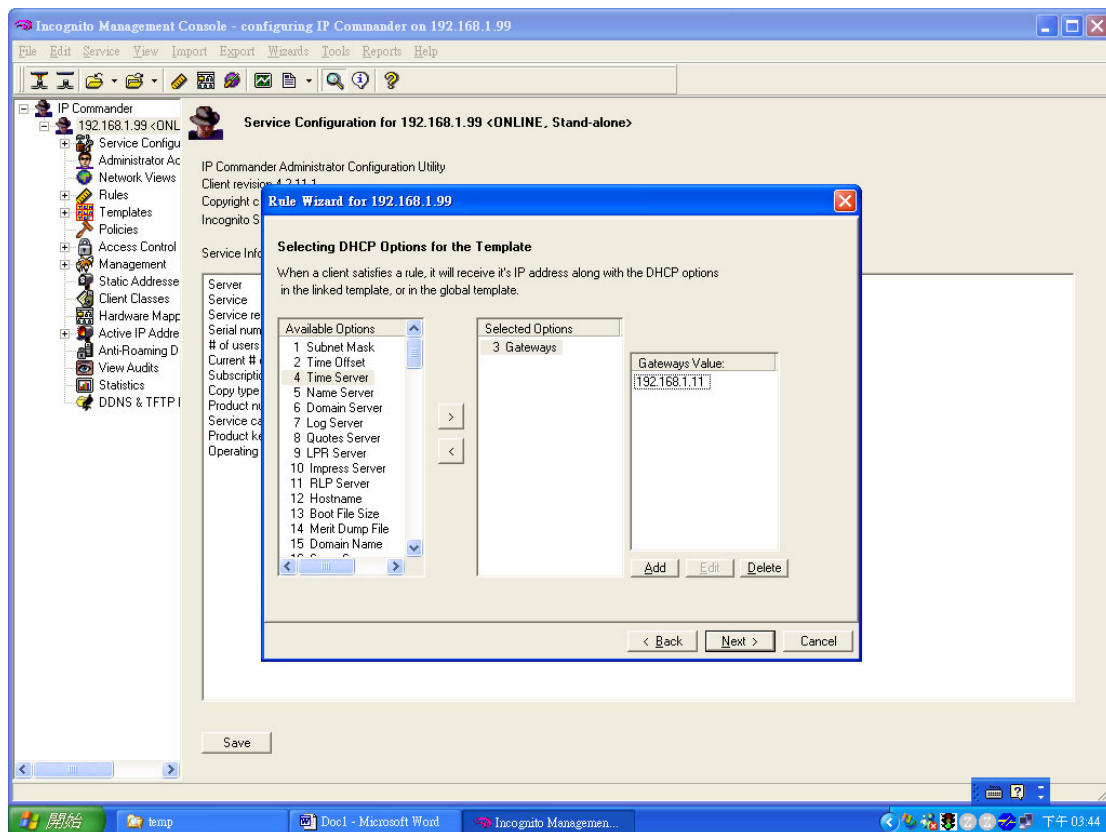

You can apply DDNS service to DHCP server or not.

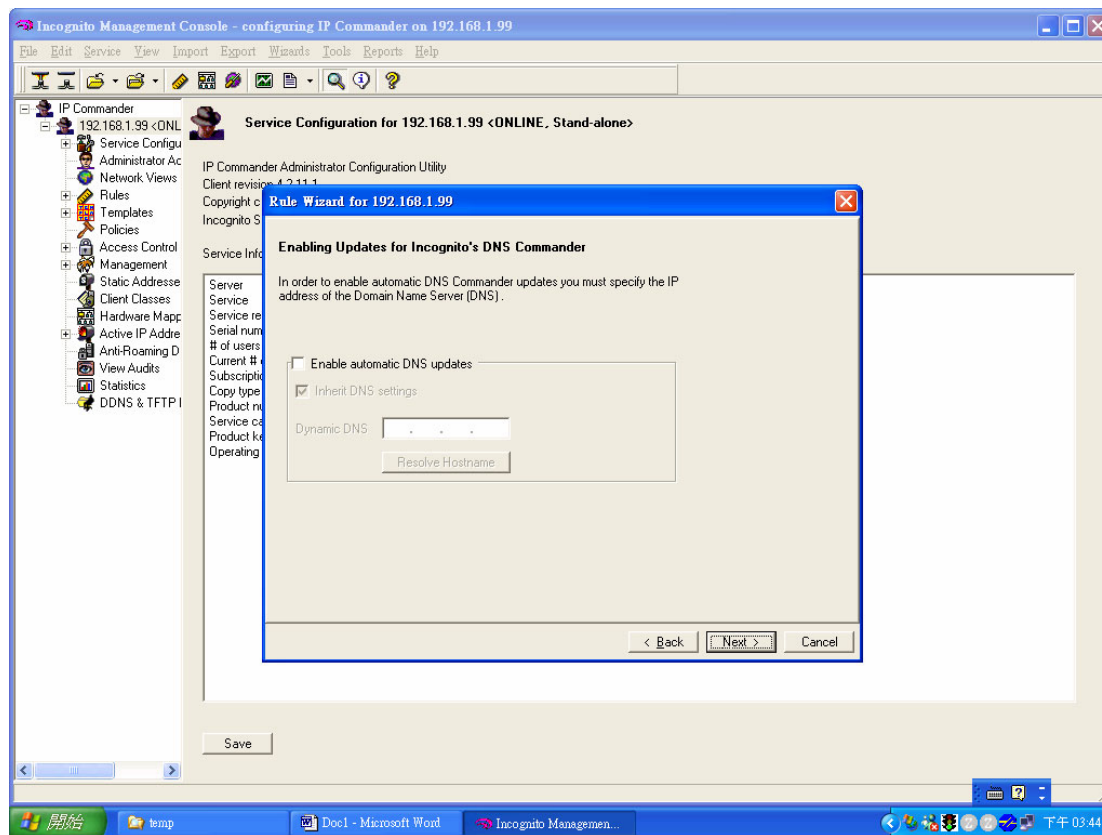

The rule creation has been finished.

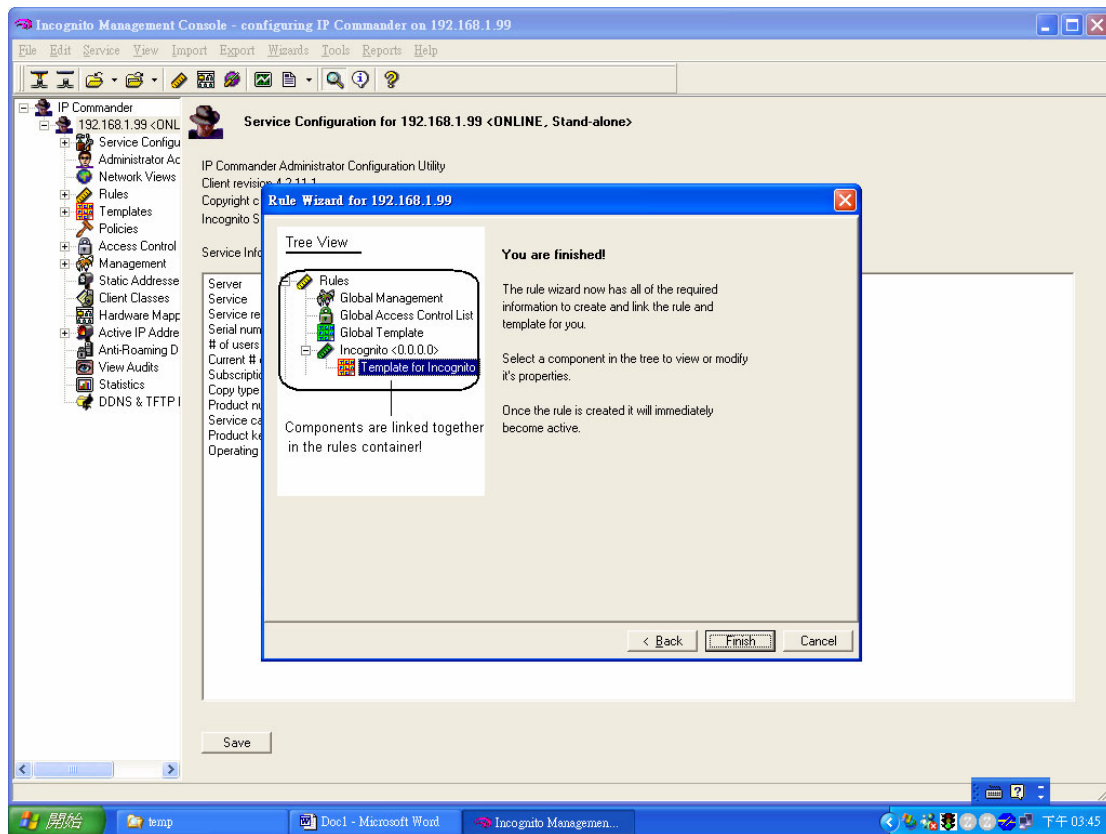

After finishing all above procedures, your PC will get the IP address 192.168.1.201 when you send a DHCP request.

Separating a physical network into many virtual networks

What is Virtual LAN?

- **VLAN Overview**

A VLAN (Virtual Local Area Network) allows a physical network to be partitioned into multiple logical networks. Stations on a logical network belong to one group called VLAN Group. A station can belong to more than one group. The stations on the same VLAN group can communicate with each other. With VLAN, a station cannot directly talk to or hear from stations that are not in the same VLAN group(s); the traffic must first go through a router.

In MTU or IP-DSLAM applications, VLAN is vital in providing isolation and security among the subscribers. When properly configured, VLAN prevents one subscriber from accessing the network resources of another on the same LAN, thus a user will not see the printers and hard disks of another user in the same building.

VLAN also increases network performance by limiting broadcasts to a smaller and more manageable logical broadcast domain. A VLAN group is a broadcast domain. In traditional Layer-2 switched environments, all broadcast packets go to each and every individual port. With VLAN, all broadcasts are confined to a specific broadcast domain.

There are two most popular VLAN implementations, Port-based VLAN and IEEE 802.1q Tagged VLAN. GS-3012 series supports both VLAN implementations. The most difference between both VLAN implementations is Tagged VLAN can across Layer-2 switch but Port-based VLAN cannot.

- **Port-based VLAN**

Port-based VLANs are VLANs where the packet forwarding decision is based on the destination MAC address and its associated port. You must define

outgoing ports allowed for each port when using port-based VLANs. Note that VLAN only governs the outgoing traffic, in the other word, it is unidirectional.

Therefore, if you wish to allow two subscriber ports to talk to each other, e.g., between conference rooms in a hotel, you must define the egress (outgoing port) for both ports. An egress port is an outgoing port, that is, a port through which a data packet leaves.

There are 5 hosts (Host A, B, C, D and E) connected to a 5-port layer-2 switch which supported port-based VLAN.

Case 1: Host A and Host B can talk to each other, because they are in the same VLAN group. But Host A and Host B can't talk to Host C, D, and E.

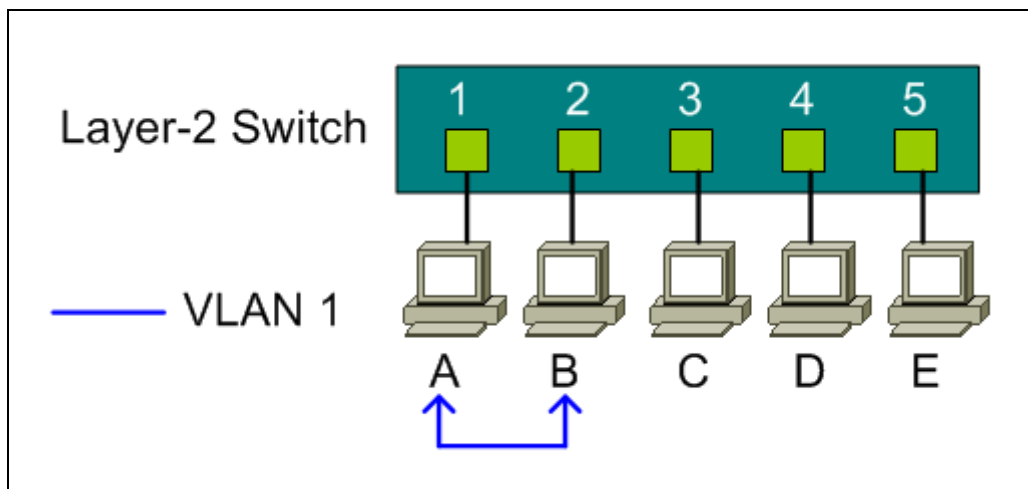

Port-based VLAN definition:

- Egress port for port 1: port 2
- Egress port for port 2: port 1

Case 2: There are 3 VLAN groups in the physical network. Host A and Host B can talk to each other; they are in the same VLAN group 1. Host B and Host C are in VLAN group 2. Host A, Host D and Host E are in VLAN group 3.

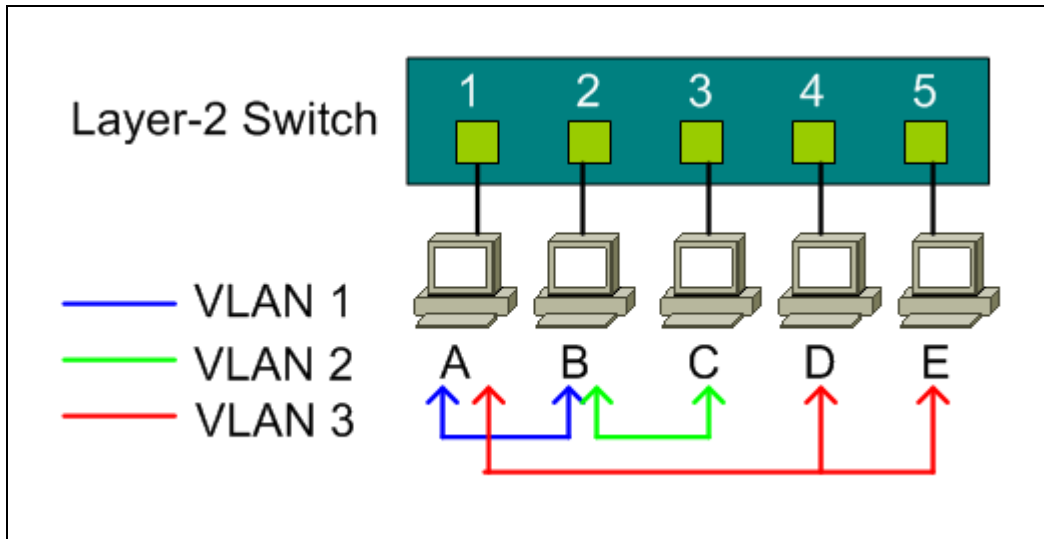

Port-based VLAN definition:

- Egress port for port 1: port 2, port 4, port 5
- Egress port for port 2: port 1, port 3
- Egress port for port 3: port 2
- Egress port for port 4: port 1, port 5
- Egress port for port 5: port 1, port 4

• Port-based VLAN across different switch

Port-based VLAN is specific only to the switch on which it was created. Definitely, Port-based VLAN can't across different switches. As the following network diagram shown in most MTU case, for the sake of security, subscribers are isolated with each other except for the gateway. There are two switches, Switch-2 and Switch-3, supported port-based VLAN and uplink to a none-port-based VLAN switch, Switch-1.

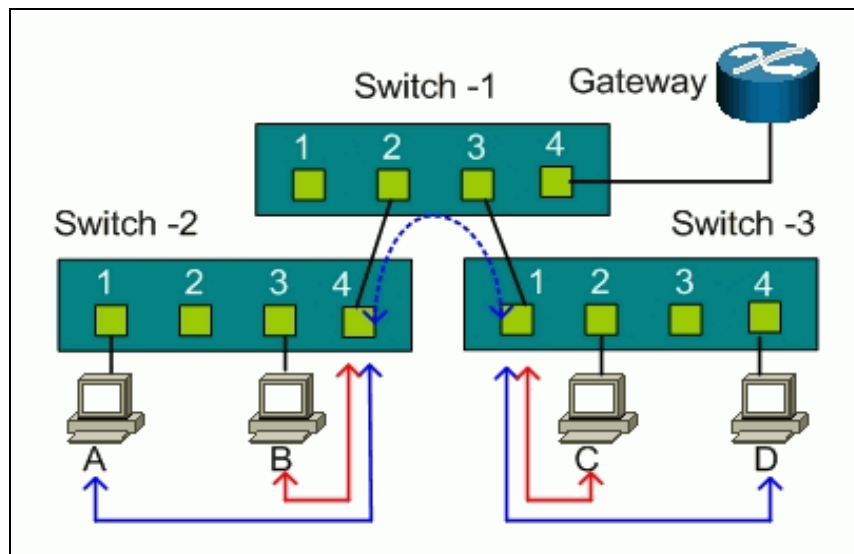

For Switch-2, port 1, port 2, and port 3 are allowed to communicate back and forth with uplink port 4, but not with other ports.

- Switch-2 VLAN 1 member port: port 1 and port 4
- Switch-2 VLAN 2 member port: port 2 and port 4
- Switch-2 VLAN 3 member port: port 3 and port 4

For Switch-3, port 2, port 3, and port 4 are allowed to communicate back and forth with uplink port 1, but not with other ports.

- Switch-3 VLAN 1 member port: port 2 and port 1
- Switch-3 VLAN 2 member port: port 3 and port 1
- Switch-2 VLAN 3 member port: port 4 and port 1

Host A can't talk to Host B due to the port-based VLAN in Switch-2, and Host C can't talk to Host D due to the port-based VLAN in Switch-3. But both Switch-2 and Switch-3 uplink to the none VLAN Switch-1. Host A and Host B will talk to Host C and Host D via the none VLAN switch because port-based VLAN can't across different switches.

To achieve the security between different switches, you must put another port-based VLAN switch for the uplink. Each port on the uplink switch also should be separated into different VLAN, except for the port to the gateway. So subscribers only can talk to the gateway for Internet access but not communicate with each other.

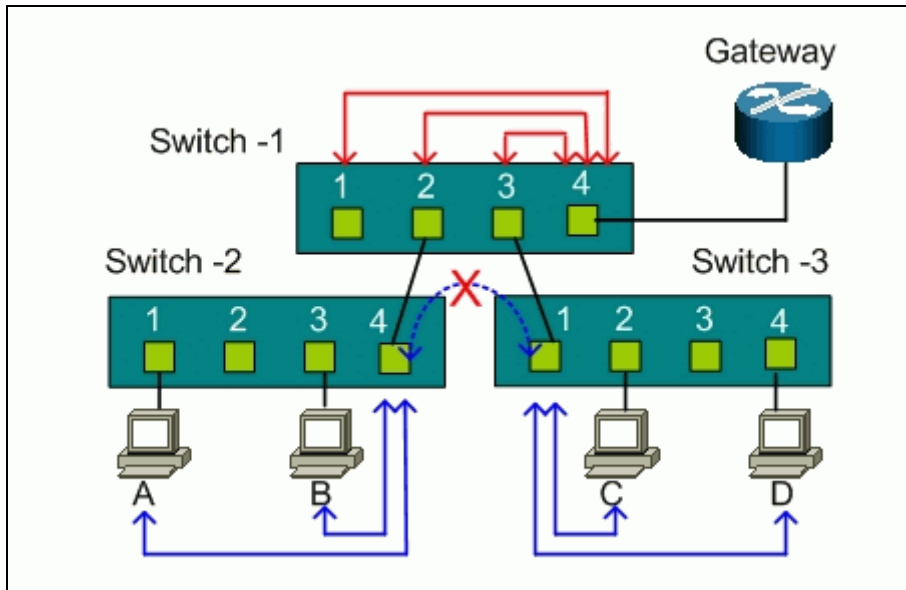

For Switch-1, port 1, port2, and port 3 are allowed to communicate back and forth with uplink port 4, but not with other ports.

- Switch-1 VLAN 1 member port: port 1 and port 4
- Switch-1 VLAN 2 member port: port 2 and port 4
- Switch-1 VLAN 3 member port: port 3 and port 4

How to configure Port-Based VLAN

Port-based VLANs are VLANs where the packet forwarding decision is based on the destination MAC address and its associated port.

Scenario

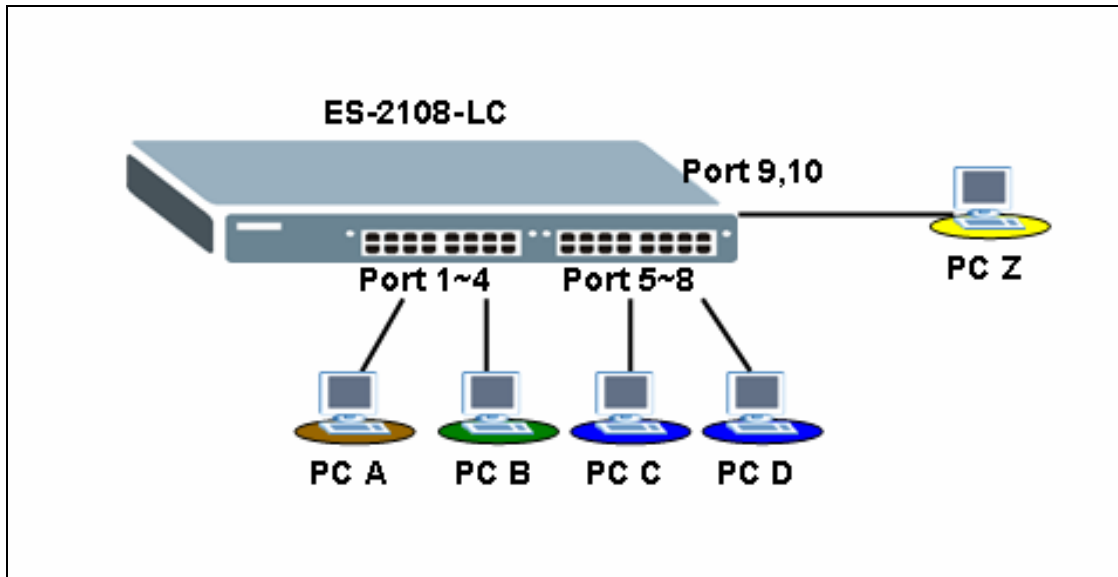

In this scenario, Port Based VLAN is used to separate one physical Switch into two smaller logical Switches. Port 1~4 and 9, 10 are in one group. And Port 5~10 are in another group. Port-based VLANs are specific only to the switch on which they were created.

Configuring your Switch to fulfill this scenario (GUI)

1. Connect port 1 with a PC or Notebook via the RJ45 Cable.
2. By default the MGMT IP on every port is 192.168.1.1/24
3. Set your NIC to 192.168.1.2/24
4. Open an Internet browser such as IE and give <http://192.168.1.1> on the URL.
5. By default you will need to put “admin” as the username and “1234” as the password.
6. After you login successfully, you will see a similar screen like below.

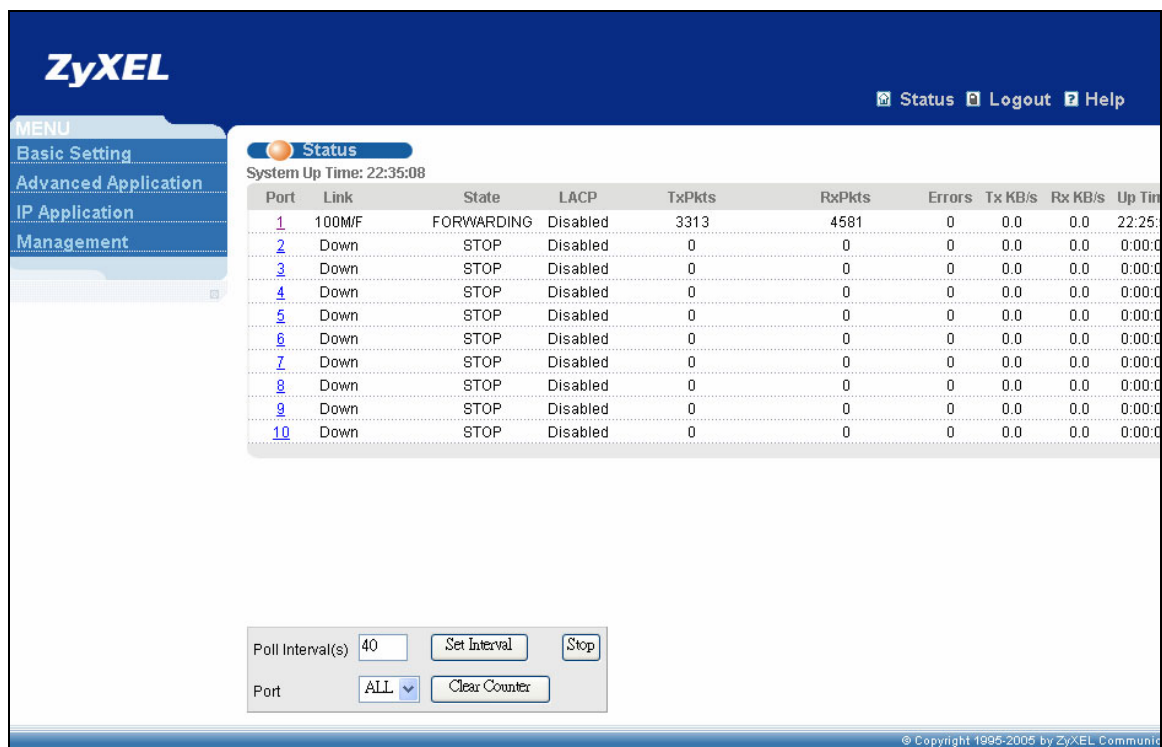

ZyXEL Status Logout Help

MENU
Basic Setting
Advanced Application
IP Application
Management

Status
System Up Time: 22:35:08

Port	Link	State	LACP	TxPkts	RxPkts	Errors	Tx KB/s	Rx KB/s	Up Time
1	100M/F	FORWARDING	Disabled	3313	4581	0	0.0	0.0	22:25:00
2	Down	STOP	Disabled	0	0	0	0.0	0.0	0:00:00
3	Down	STOP	Disabled	0	0	0	0.0	0.0	0:00:00
4	Down	STOP	Disabled	0	0	0	0.0	0.0	0:00:00
5	Down	STOP	Disabled	0	0	0	0.0	0.0	0:00:00
6	Down	STOP	Disabled	0	0	0	0.0	0.0	0:00:00
7	Down	STOP	Disabled	0	0	0	0.0	0.0	0:00:00
8	Down	STOP	Disabled	0	0	0	0.0	0.0	0:00:00
9	Down	STOP	Disabled	0	0	0	0.0	0.0	0:00:00
10	Down	STOP	Disabled	0	0	0	0.0	0.0	0:00:00

Poll Interval(s) 40 Set Interval Stop

Port ALL Clear Counter

© Copyright 1995-2005 by ZyXEL Communication

7. First, we need to tell the Switch to run VLAN as port based instead of 802.1q based. In order to do so, we first click on the “Basic Setting”, then “Switch Setup”; on your right screen the VLAN Type, choose “Port Based” instead of “802.1Q”, and click “Apply” to save your changes.

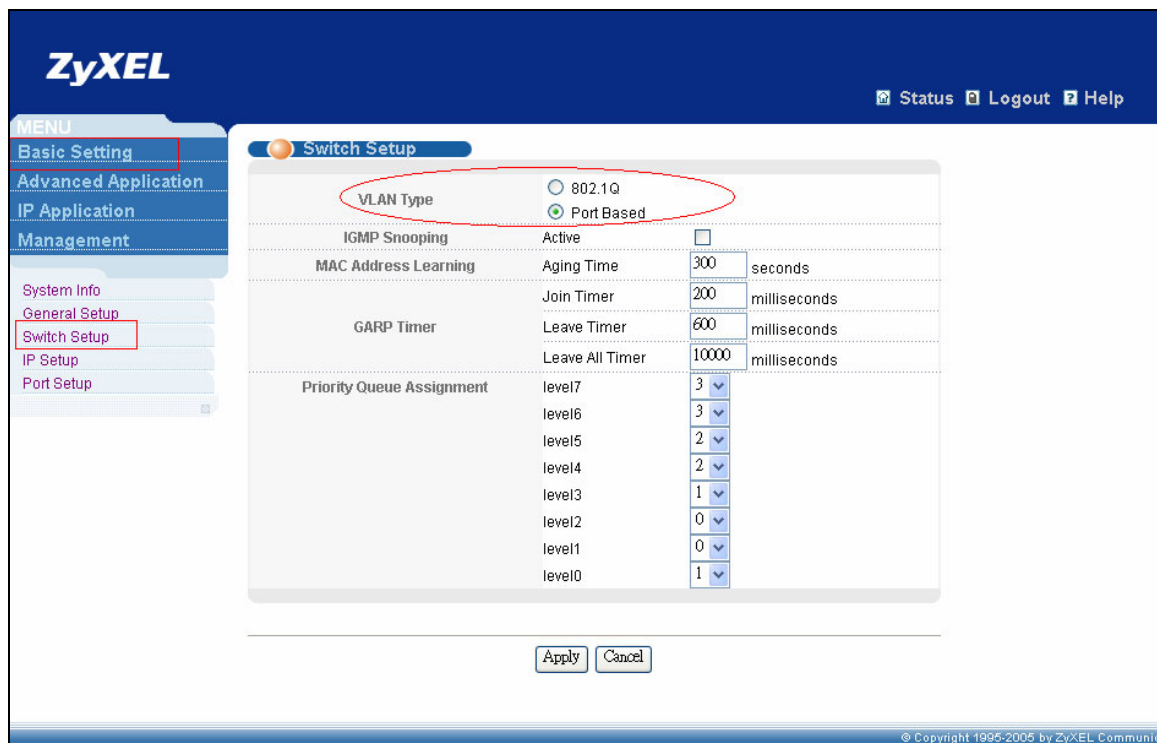

- Now, you need to tell the Switch how you are going to separate the physical Switch into some logical small Switches. Thus, we click “Advanced Application” then “VLAN”. On the right screen, check the boxes to suit your need. In this case, we need to make port 1~4 and port 9, 10 in a group in order for them to communicate in both ways. And port 5~10 in another group but these two groups cannot talk with each others. Here we also logically defined Port 9 and Port 10 as the uplink ports. Therefore, both groups can pass data to Port 9 and Port 10. In another word, these two ports belong to both of the groups on the same time. Please confirm if your setting looks similar to below.

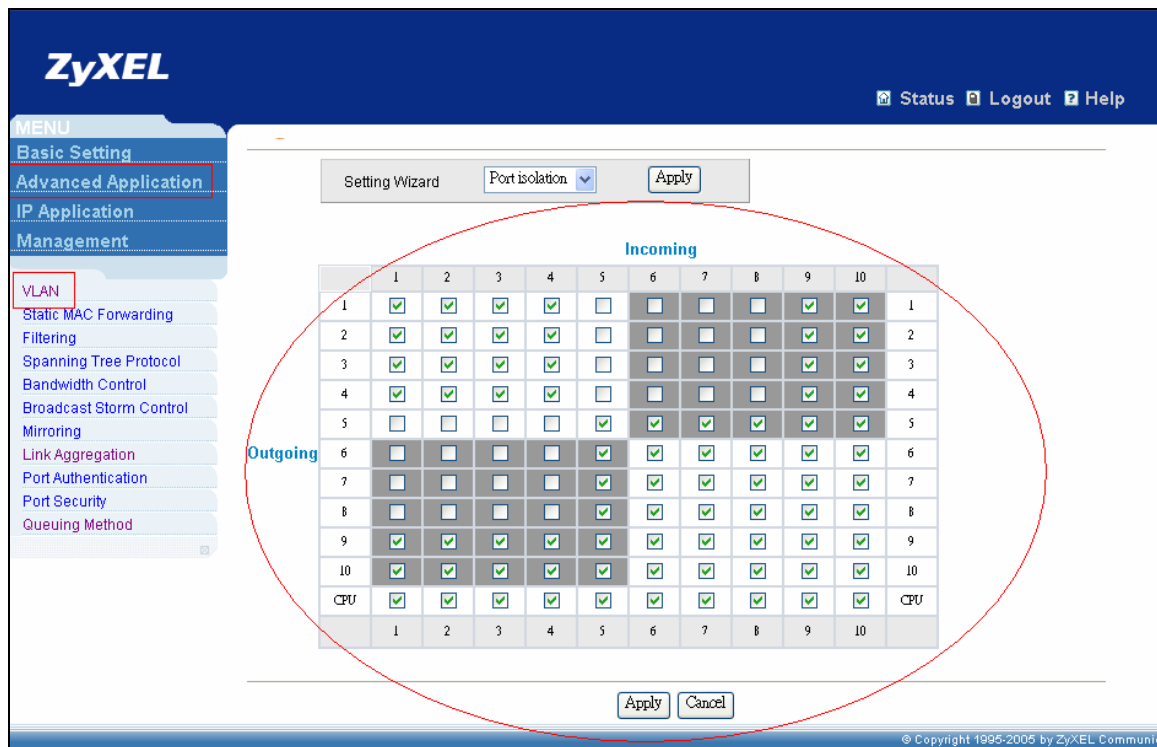

9. Finally, you can now verify your result. If everything works fine, PC A can ping PC B and PC Z. But it cannot ping PC C or PC D. On the same time, this should work vice versa.

10. For example,

PC A: 192.168.1.4/24

PC B: 192.168.1.5/24

PC C: 192.168.1.6/24

PC D: 192.168.1.7/24

PC Z: 192.168.1.99/24

11. PING PC B from PC A (Should work)

```
C:\>ping 192.168.1.5

Pinging 192.168.1.5 with 32 bytes of data:

Reply from 192.168.1.5: bytes=32 time=12ms TTL=254
Reply from 192.168.1.5: bytes=32 time=6ms TTL=254
Reply from 192.168.1.5: bytes=32 time=7ms TTL=254
Reply from 192.168.1.5: bytes=32 time=6ms TTL=254

Ping statistics for 192.168.1.5:
    Packets: Sent = 4, Received = 4, Lost = 0 (0% loss),
Approximate round trip times in milli-seconds:
    Minimum = 6ms, Maximum = 12ms, Average = 7ms
```

12. PING PC Z from PC A (Should work)

```
C:\>ping 192.168.1.99

Pinging 192.168.1.99 with 32 bytes of data:

Reply from 192.168.1.99: bytes=32 time=15ms TTL=254
Reply from 192.168.1.99: bytes=32 time=6ms TTL=254
Reply from 192.168.1.99: bytes=32 time=6ms TTL=254
Reply from 192.168.1.99: bytes=32 time=7ms TTL=254

Ping statistics for 192.168.1.99:
    Packets: Sent = 4, Received = 4, Lost = 0 (0% loss),
Approximate round trip times in milli-seconds:
    Minimum = 6ms, Maximum = 15ms, Average = 8ms
```

13. PING PC C from PC A (Should NOT work)

```
C:\>ping 192.168.1.6

Pinging 192.168.1.6 with 32 bytes of data:

Request timed out.
Request timed out.
Request timed out.
Request timed out.

Ping statistics for 192.168.1.6:
    Packets: Sent = 4, Received = 0, Lost = 4 (100% loss),
```

Configuring your Switch to fulfill this scenario (CLI)

1. Connect the Switch Console port with your PC or Notebook.
2. Open your Terminal program.(Ex, Hyper Terminal in Windows System)
3. Make sure that your port settings are
 - bps:9600
 - Data bits:8
 - Parity: None
 - Stop bits:1
 - Flow control: None:
4. After you connected successfully, give the correct user name and password.
5. Put “en” or “enable” to go into the privileged mode. Then put “config” to go into the configuration mode.
6. Put the following commands to setup Port Based VLAN on your Switch in this

scenario.

```
vlan-type port-based
interface port-channel 1
  no egress set 5-8
exit
interface port-channel 2
  no egress set 5-8
exit
interface port-channel 3
  no egress set 5-8
exit
interface port-channel 4
  no egress set 5-8
exit
interface port-channel 5
  no egress set 1-4
exit
interface port-channel 6
  no egress set 1-4
exit
interface port-channel 7
  no egress set 1-4
exit
interface port-channel 8
  no egress set 1-4
exit
```

7. When all of the above are done, do not forget to give the “write memory” command under the enable mode to save your configuration.

What is IEEE 802.1Q Tag-based VLAN?

- **Tag-based VLAN Overview**

Regarding IEEE 802.1Q standard, Tag-based VLAN uses an extra tag in the MAC header to identify the VLAN membership of a frame across bridges. This tag is used for VLAN and QoS (Quality of Service) priority identification. The VLANs can be created statically by hand or dynamically through GVRP. The **VLAN ID** associates a frame with a specific VLAN and provides the information that switches need to

process the frame across the network. A tagged frame is four bytes longer than an untagged frame and contains two bytes of TPID (Tag Protocol Identifier, residing within the type/length field of the Ethernet frame) and two bytes of TCI (Tag Control Information, starts after the source address field of the Ethernet frame).

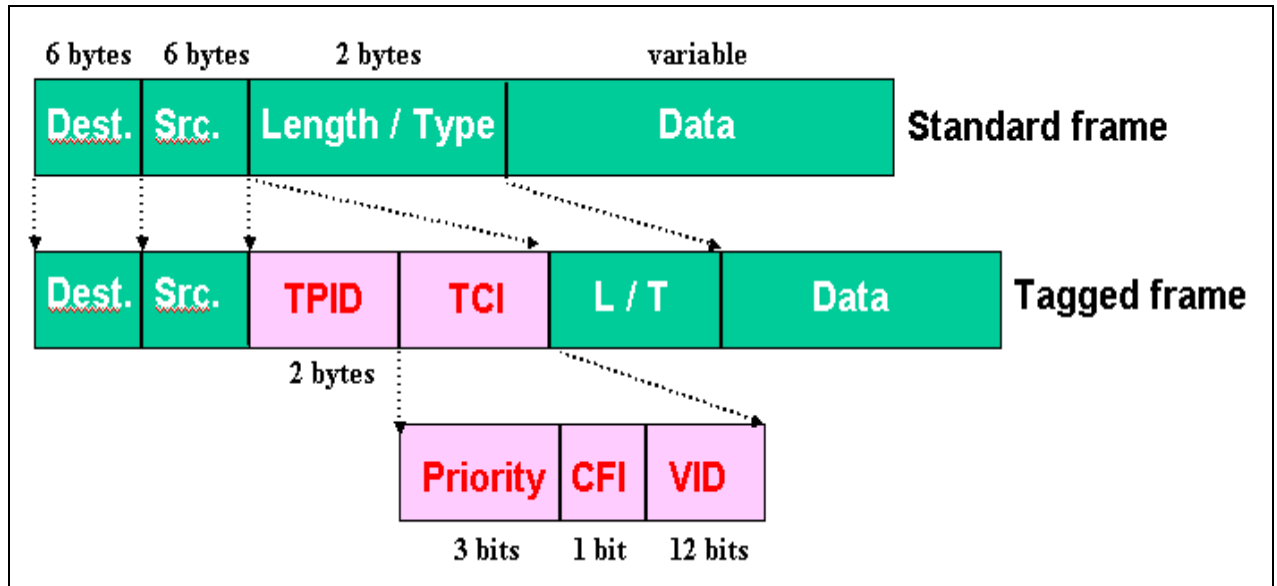

- **TPID:** TPID has a defined value of 8100 in hex. When a frame has the EtherType equal to 8100, this frame carries the tag IEEE 802.1Q / 802.1P.
- **Priority:** The first three bits of the TCI define user priority, giving eight (2^3) priority levels. IEEE 802.1P defines the operation for these 3 user priority bits.
- **CFI:** Canonical Format Indicator is a single-bit flag, always set to zero for Ethernet switches. CFI is used for compatibility reason between Ethernet type network and Token Ring type network. If a frame received at an Ethernet port has a CFI set to 1, then that frame should not be forwarded as it is to an untagged port.
- **VID:** VLAN ID is the identification of the VLAN, which is basically used by the standard 802.1Q. It has 12 bits and allows the identification of 4096 (2^{12}) VLANs. Of the 4096 possible VIDs, a VID of 0 is used to identify priority frames and value 4095 (FFF) is reserved, so the maximum possible VLAN configurations are 4,094.

Note that user priority and VLAN ID are independent of each other. A frame with VID (VLAN Identifier) of null (0) is called a priority frame, meaning that only the priority level is significant and the default VID of the ingress port is given as the VID of the frame.

- **How 802.1Q VLAN works**

According to the VID information in the tag, the switch forward and filter the frames among ports. These ports with same VID can communicate with each other. IEEE 802.1Q VLAN function contains the following three tasks, Ingress Process, Forwarding Process and Egress Process.

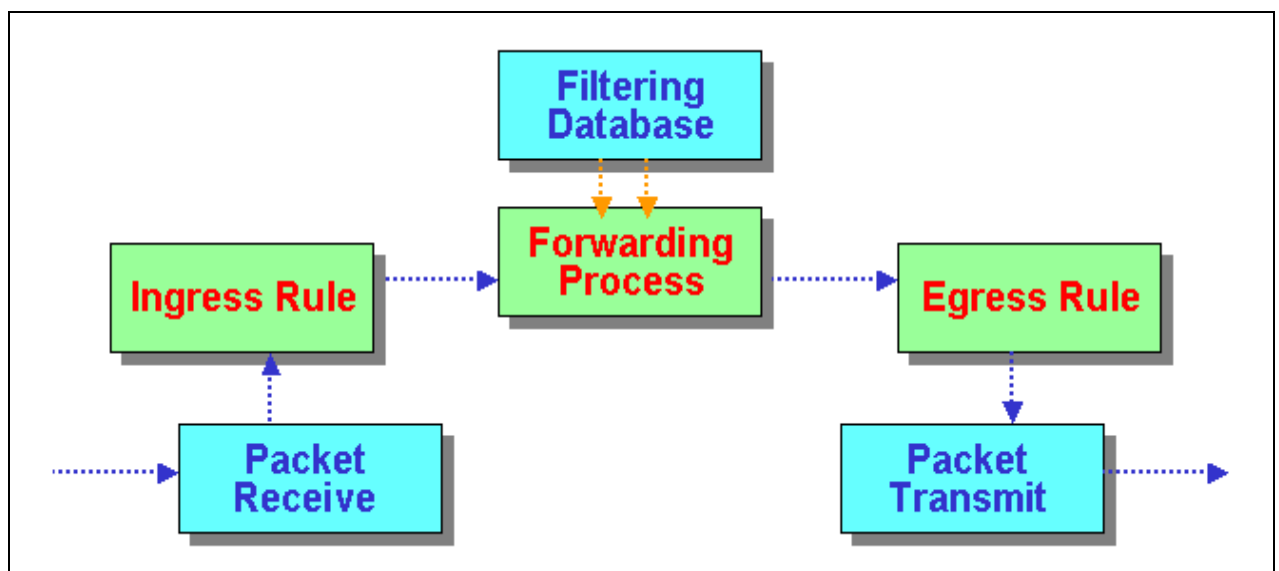

1. Ingress Process:

Each port is capable of passing tagged or untagged frames. Ingress Process identifies if the incoming frames contain tag, and classifies the incoming frames belonging to a VLAN. Each port has its own Ingress rule. If Ingress rule accept tagged frames only, the switch port will drop all incoming non-tagged frames. If Ingress rule accept all frame type, the switch port simultaneously allow the incoming tagged and untagged frames:

- When a tagged frame is received on a port, it carries a tag header that has a explicit VID. Ingress Process directly pass the tagged frame to Forwarding Process.
- An untagged frame doesn't carry any VID to which it belongs. When a

untagged frame is received, Ingress Process insert a tag contained the PVID into the untagged frame. Each physical port has a default VID called PVID (Port VID). PVID is assigned to untagged frames or priority tagged frames (frames with null (0) VID) received on this port.

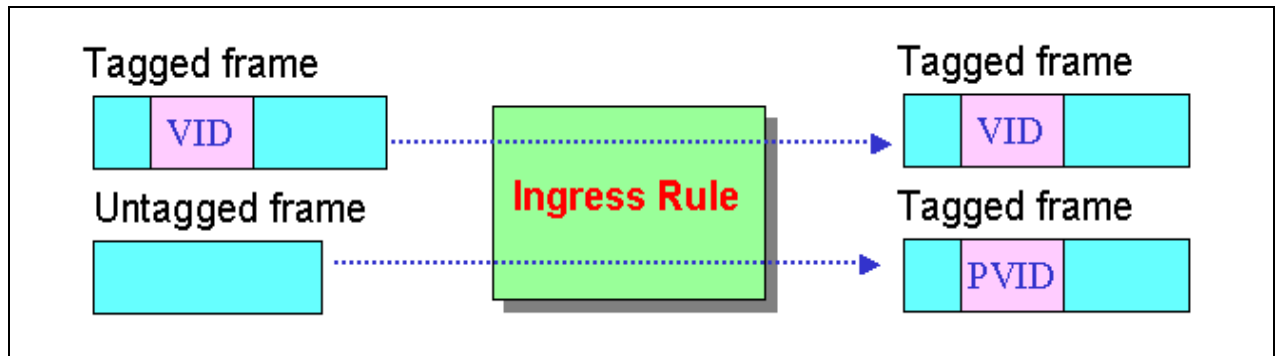

After Ingress Process, all frames have 4-bytes tag and VID information, and then go to Forwarding Process.

2. Forwarding Process:

The Forwarding Process decides to forward the received frames according to the Filtering Database. If you want to allow the tagged frames can be forwarded to certain port, this port must be the egress port of this VID. The egress port is an outgoing port for the specified VLAN, that is, frames with specified VID tag can go through this port. The Filtering Database stores and organizes VLAN registration information useful for switching frames to and from switch ports. It consists of static registration entries (Static VLAN or SVLAN table) and dynamic registration entries (Dynamic VLAN or DVLAN table). SVLAN table is manually added and maintained by the administrator. DVLAN table is automatically learned via GVRP protocol, and can't be created and upgraded by the administrator.

The VLAN entries in Filtering Database have the following information:

1. **VID:** VLAN ID
2. **Port:** The switch port number
3. **Ad Control:** Registration administration control. There are 3 type of ad control, including **forbidden** registration, **fixed** registration and **normal** registration.

- **Forbidden** registration: This port is forbidden to be the egress port of specified VID..
 - **Fixed** registration: While ad control is fixed registration, it means this is a static registration entry. This port is the egress port of the specified VID (a member port of the specified VLAN). The frames with specified VID tag can go through this port.
 - **Normal** registration: While ad control is normal registration, it means this is a dynamic registration entry. The forwarding decision is depended on Dynamic VLAN table.
4. **Egress tag Control:** This information is used for Egress Process. The value may be tagged or untagged. If the value is tagged, the outgoing frame on the egress port is tagged. If the value is untagged, the tag will be removed before frame leaves the egress port.

VID	Port	Ad Control	Tag Control
10	1	Forbidden	Tag
10	2	Fixed	Tag
10	3	Normal	UnTag
20	1	Fixed	Tag
20	5	Fixed	UnTag

Filtering Database

VID	Egress Port
10	1
10	2
20	3

Dynamic VLAN (DVLAN) table

3. Egress Process:

The Egress Process decides if the outgoing frames but be sent tagged or untagged. The Egress Process refers to the egress tag control information in

Filtering Database. If the value is tagged, the outgoing frame on the egress port is tagged. If the value is untagged, the tag will be removed before frame leaves the egress port.

How to connect two switches using VLAN?

I want to make VLAN on two layer 2 switches, and I want to connect first switch to second switch with trunk port. There will be 5 VLAN on first Switch and there will be 7 VLAN on second switch. Trunk port will be port 25 on both switches as well. I made VLAN s on both switch, but I did not find trunk options on both switches. How can I use Port 25 as trunk port?

The scenario is described as below:

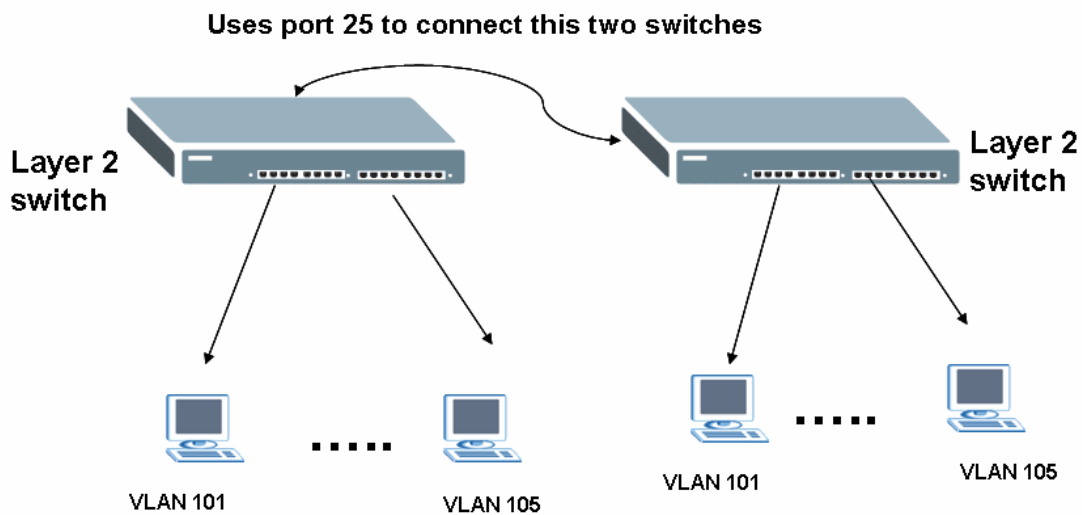

Where the configurations of VLAN in this two switches are:

VLAN 2, 3, 4, 5, 6, 7, 8 on switch A

VLAN 2, 3, 4, 5, 6 on switch B

Configuration of VLAN on switch A

Index	VID	2	4	6	8	10	12	14	16	18	20	22	24	26	Elapsed Time	Status
		1	3	5	7	9	11	13	15	17	19	21	23	25		
1	1	U	U	U	U	U	U	U	U	U	U	U	U	U	0:01:49	Static
		U	U	U	U	U	U	U	U	U	U	U	U	U		
2	101	U	-	-	-	-	-	-	-	-	-	-	-	-	0:01:49	Static
		U	U	-	-	-	-	-	-	-	-	-	-	-		
3	102	-	U	U	-	-	-	-	-	-	-	-	-	-	0:01:49	Static
		-	-	U	-	-	-	-	-	-	-	-	-	-		
4	103	-	-	-	U	U	-	-	-	-	-	-	-	-	0:01:49	Static
		-	-	-	U	U	-	-	-	-	-	-	-	-		
5	104	-	-	-	-	-	-	-	-	-	-	-	U	-	0:01:49	Static
		-	-	-	-	-	-	-	-	-	-	-	U	-		
6	105	-	-	-	-	-	U	U	-	-	-	-	-	-	0:01:49	Static
		-	-	-	-	-	U	U	-	-	-	-	-	-		
7	106	-	-	-	-	-	-	-	U	-	-	-	-	-	0:01:49	Static
		-	-	-	-	-	-	-	U	U	-	-	-	-		
8	107	-	-	-	-	-	-	-	-	U	U	-	-	-	0:01:48	Static
		-	-	-	-	-	-	-	-	U	U	-	-	-		

2. Configuration of VLAN on switch B

Number Of VLAN = 6

Index	VID	Port Number														Elapsed Time	Status
		2	4	6	8	10	12	14	16	18	20	22	24	26			
1	1	U	U	U	U	U	U	U	U	U	U	U	U	U	0:02:25	Static	
		U	U	U	U	U	U	U	U	U	U	U	U	U			
2	101	U	U	-	-	-	-	-	-	-	-	-	-	-	0:02:25	Static	
		U	U	U	-	-	-	-	-	-	-	-	-	-			
3	102	-	-	U	U	U	-	-	-	-	-	-	-	-	0:02:25	Static	
		-	-	-	U	U	-	-	-	-	-	-	-	-			
4	103	-	-	-	-	-	U	U	-	-	-	-	-	-	0:02:25	Static	
		-	-	-	-	-	U	U	-	-	-	-	-	-			
5	104	-	-	-	-	-	-	-	U	U	-	-	-	-	0:02:25	Static	
		-	-	-	-	-	-	-	U	U	-	-	-	-			
6	105	-	-	-	-	-	-	-	-	-	U	U	-	-	0:02:25	Static	
		-	-	-	-	-	-	-	-	-	U	U	U	-			

Answer:

In switch A, add port 25 in each VLAN

VID:101 (port 1,2,3,"25 TAG")

VID:102 (port 4,5,6,,"25 TAG")

VID:103 (port 7,8,9,10,"25 TAG")

VID:104 (port 23,24,"25 TAG")

VID:105 (port 11,12,13,14,"25 TAG")

VID:106 (port 15,16,17,"25 TAG")

VID:107 (port 18,19,20,21,"25 TAG")

In switch B, add port 25 in each VLAN

VID:101 (port 1,2,3,,4,"25 TAG")

VID:102 (port 6,7,8,9,10,"25 TAG")

VID:103 (port 11,12,13,14,"25 TAG")

VID:104 (port 15,16,17,18,"25 TAG")

VID:105 (port 19,20,21,23,22"25 TAG)

Clients in same VLAN on both switches can communicate each other.

PVID:

- Set PVID on switch 1

Port 1, 2, 3 : **101**

Port 4, 5, 6 : **102**

Port 7, 8, 9, 10 : **103**

Port 23, 24: **104**

Port 11, 12, 13, 14: **105**

Port 15, 16, 17: **106**

Port 18, 19, 20, 21: **107**

port 25: PVID=any

- Set PVID on switch 2:

Port 1, 2, 3, 4 : **101**

Port 6, 7, 8, 9, 10, : **102**

Port 11, 12, 13, 14, : **103**

Port 15, 16, 17, 18: **104**

Port 19, 20, 21, 22, 23: **105**

Port 25:PVID=any

IP Multicasting

How to setup IGMP snooping in your switch?

Figure 1: IGMP and IGMP snooping

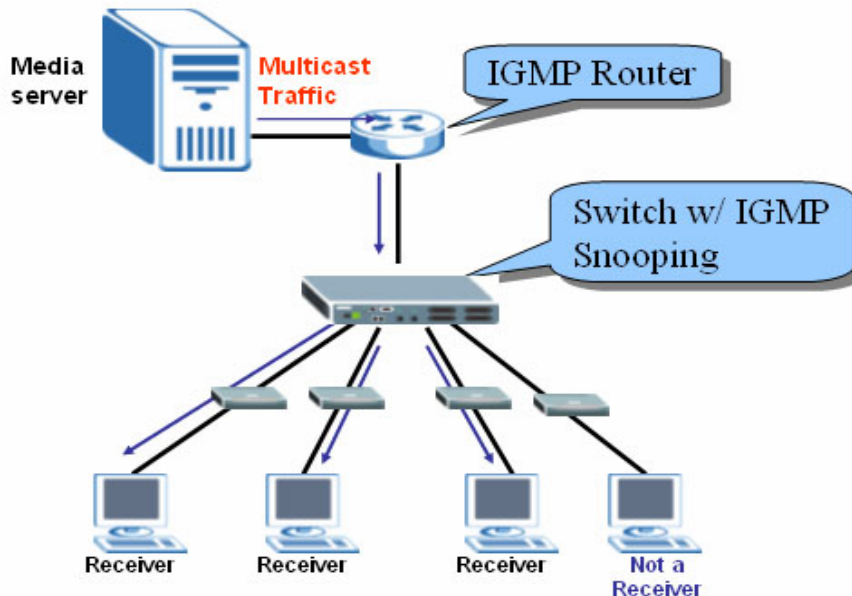

IGMP snooping is designed for application with deployment of multicast traffic. It operates on the underlying IGMP mechanism where a layer two switch passively listens to the IGMP Query, Report and Leave (IGMP version 2) packets transmitted between the IGMP router and clients and collects passing IGMP messages. After that, the switch records the message's group registration information, and configures multicasting information accordingly. If the multicast group information is unknown (not recorded on the switch), the switch discards that multicast traffic. Only the registered clients that join the group will receive multicast stream from the IGMP router. Thus this significantly reduces the multicast traffic forwarded down to the clients. Another advantage of IGMP snooping is to allow the intermediate switch to learn multicast group information without manually configuring switches.

Configuration of IGMP snooping by web

In this example, we enable the IGMP function on the GS-4024 (an IGMP router) to connect to a multimedia server. Also, we enable IGMP snooping function on the ES-3124 or other ZyXEL L2 Switch to connect to the multimedia clients.

Figure 2: IGMP snooping Example

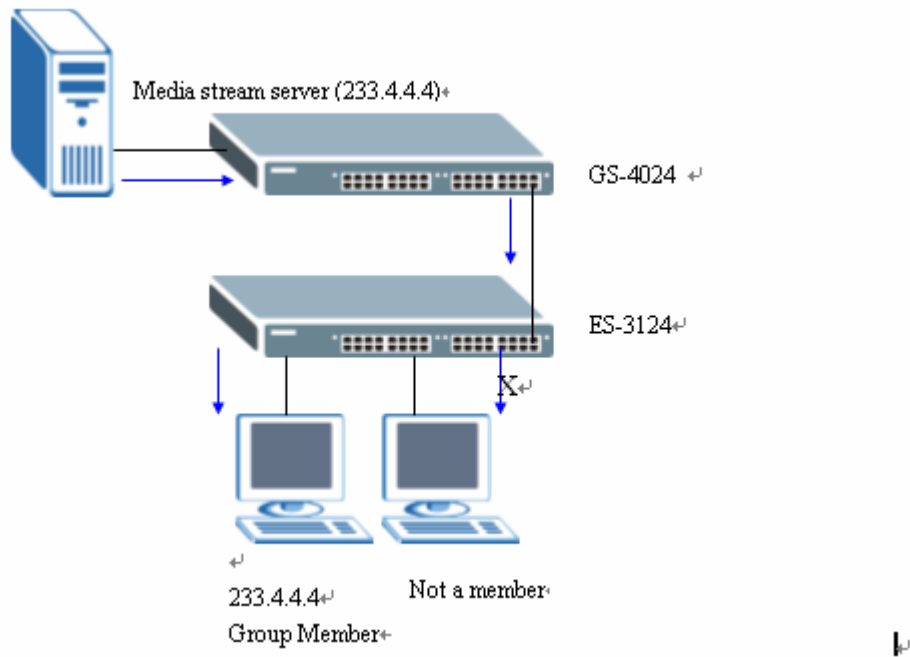

Step one: In the GS-4024, click the **IP Application**, select **IGMP** where, IGMP function can be enabled and we can select either IGMP-v1 or IGMP-v2.

Figure 3: IGMP Setup

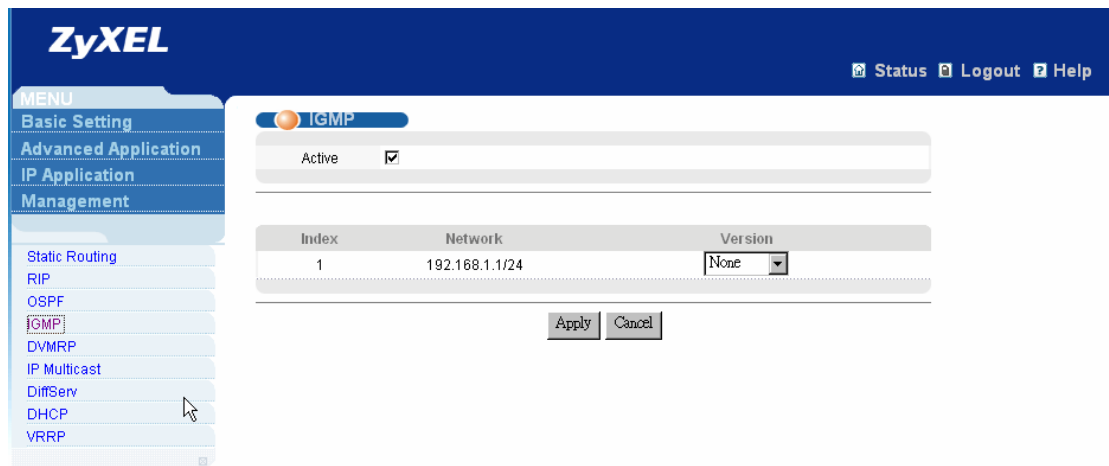

Step two: In the L2 Switch, click **Basic Setting** and then **Switch Setup** where we can enable IGMP snooping function with WEB-GUI.

Figure 4: IGMP Snooping Setup

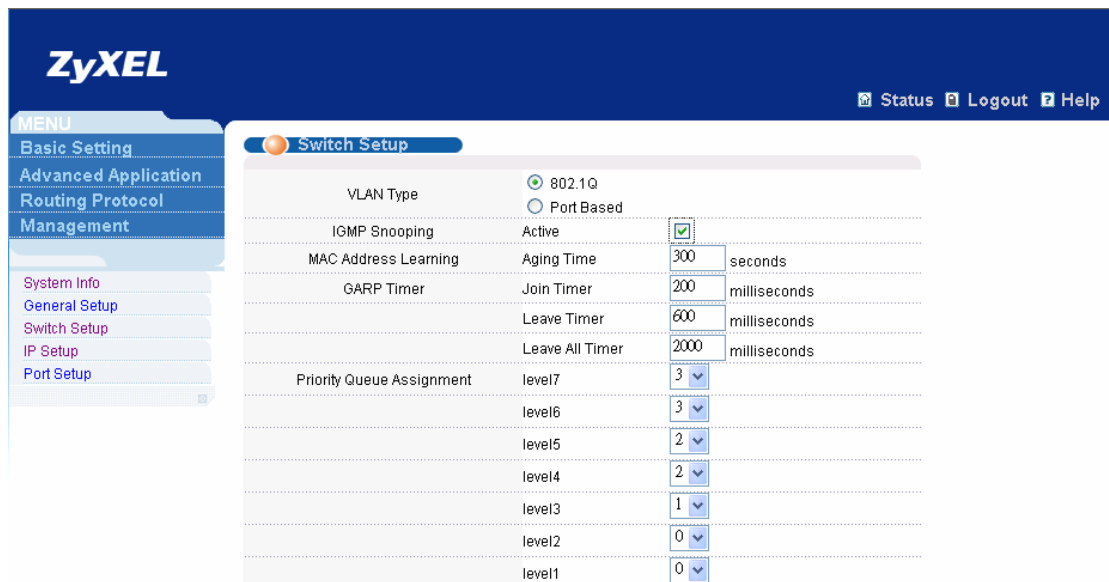

Configuration of IGMP and IGMP snooping by CLI

Step one: Enable IGMP function

In the configure mode

GS-4024(config)# **router igmp**

Step two: Enable IGMP snooping

In the configure mode of CLI,
L2Switch(config)# **igmp-snooping**

Step three: Display the IGMP Status

In the exec mode of CLI
GS-4024# **show router igmp**

Step Four: Display the IGMP snooping Status

In the exec mode of CLI
L2Switch# **show igmp-snooping**

Note: One thing needs to be mentioned is that in the IGMP router, we do not need to enable IGMP snooping function.

Overview of MVR

MVR refers to Multicast VLAN Registration that enables a media server to transmit multicast stream in a single multicast VLAN while clients receiving multicast VLAN stream can reside in different VLANs. Clients in different VLANs intend to join or leave the multicast group simply by sending the IGMP Join/leave message to a receiver port. The receiver port belongs to one of the multicast group can receive multicast stream from media server. In the Figure 1, without support of MVR, the Multicast stream from media server and subscriber must reside in the same VLAN. For each VLAN, A media server is required to transmit multicast stream once and totally, media server transmits 6 times. In the Figure 2, on the contrary, with MVR, a media server is required to transmit multicast traffic once to clients in different VLANs.

Figure 1

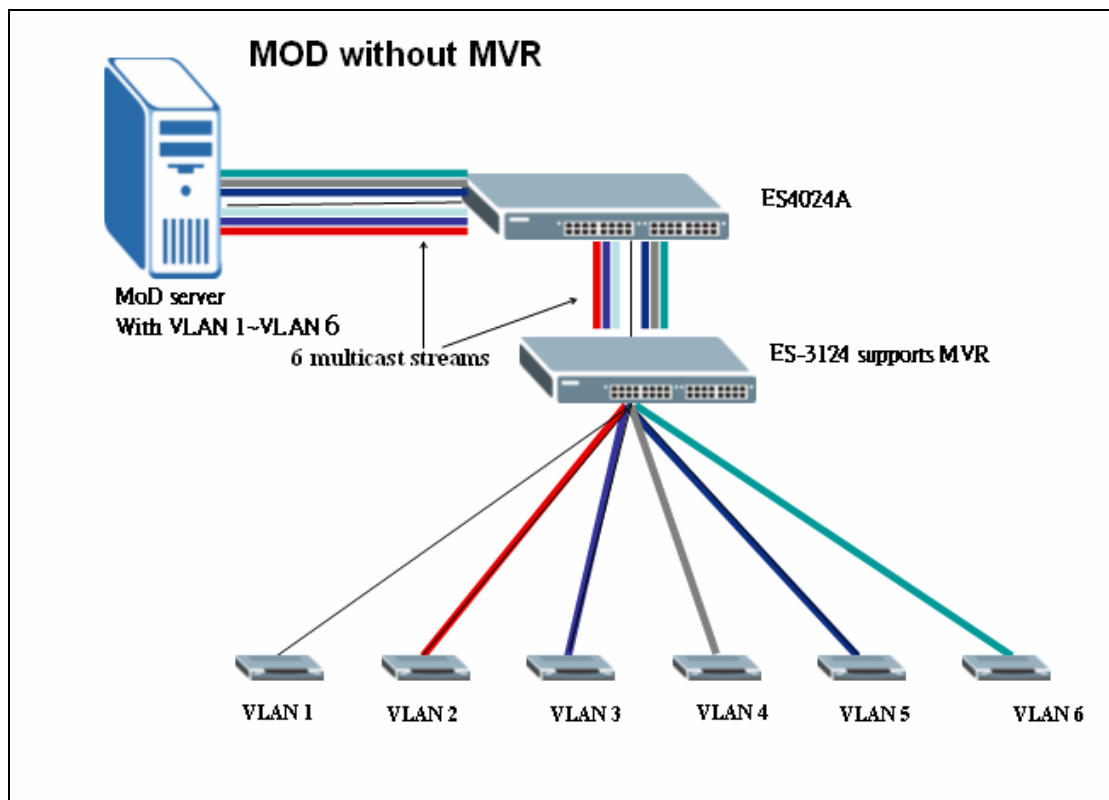
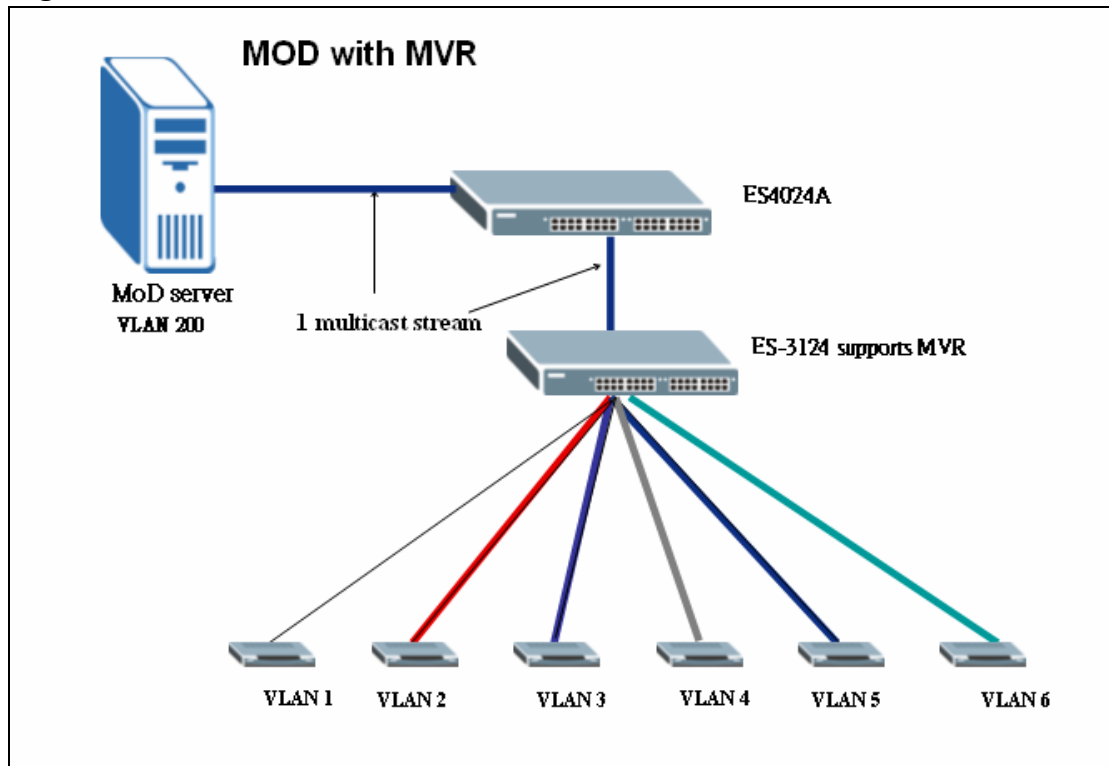

Figure 2



MVR Mode

◆ Dynamic Mode

If we select the dynamic mode in MVR setting, IGMP report message transmitted from the receiver port will be forwarded to a multicast router through its source port. Multicast router knows which multicast groups exist on which interface dynamically.

◆ Compatible mode

If we select the dynamic mode in MVR setting, IGMP report message transmitted from the receiver port will not be transmitted to a multicast router. Multicast router must be statically configured.

Operation Mode

◆ Join Operation

A subscriber sends an IGMP report message to the switch to join the appropriate multicast. Whether IGMP report matches the switch

configured multicast MAC address. If matches, the switch CPU modifies the hardware address table to include this receiver port and VLAN as a forwarding destination of the MVLAN

◆ **Leave Operation**

Subscriber sends an IGMP leave message to the switch to leave the multicast. The switch CPU sends an IGMP group-specific query through the receiver port VLAN. If there is another subscriber in the VLAN, subscriber must respond within the max response time. If there is no subscriber, the switch eliminates this receiver port.

◆ **Immediate Leave Operation**

Subscriber sends an IGMP leave message to the switch to leave the multicast. Subscribers do not need to wait the switch CPU to send an IGMP group-specific query through the receiver port VLAN. The switch will immediately eliminate this receiver port.

Scenario of MVR

In the following section, we will provide an example to illustrate how to configure MVR. In this scenario, the main job of media server is to transmit the media stream via port 10 to ES-4024A and the multicast traffic flowing into the ES-4024A will be tagged with PVID=100. In the ES-3124, we enable the MVR function to allocate the multicast traffic from ES-4024A to separate VLAN hosts.

Figure 3 illustration of MVR

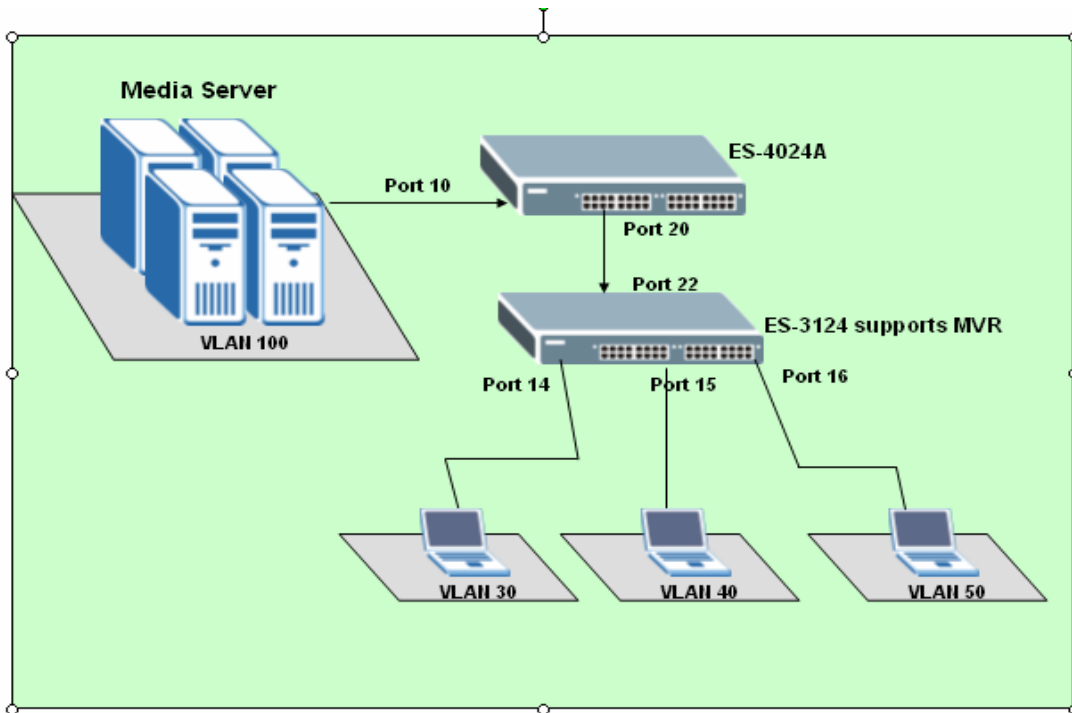

Configuration via Web

Step 1: We need to create a VLAN for multicast traffic in ES-4024A. In the **ES-4024A**, Click the **Advanced Application** and then select the **VLAN** and in the VLAN Configuration, create a new VLAN 100.

Figure 4 VLAN Configuration

VLAN Status		VLAN Port Setting														Static VLAN		
The Number Of VLAN = 2																		
Index	VID	Port Number														Elapsed Time	Status	
		2	4	6	8	10	12	14	16	18	20	22	24	26	S2			
1	1	U	U	U	U	U	U	U	U	U	U	U	U	U	U	U	0:00:52	Static
		U	U	U	U	U	U	U	U	U	U	U	U	U	U			
2	100	-	-	-	-	U	-	-	-	-	T	-	-	-	-	-	0:00:51	Static
		-	-	-	-	-	-	-	-	-	-	-	-	-	-			

Step 2, In the **ES-4024A**, click the **Advanced Application** and then select the **VLAN**. In the **VLAN port Setting**, please be noted to set the PVID of the port 10 to 100 as the multicast traffic that flowing from media server in port 10 must be tagged with PVID=100 to communicate with the port in MVR VLAN 100 in ES-3124.

Figure 5 VLAN Port Setting

VLAN Port Setting
VLAN Status

GVRP

Port isolation

Port	Ingress Check	PVID	GVRP	Acceptable Frame Type	VLAN Trunking
1	<input type="checkbox"/>	1	<input type="checkbox"/>	All	<input type="checkbox"/>
2	<input type="checkbox"/>	1	<input type="checkbox"/>	All	<input type="checkbox"/>
3	<input type="checkbox"/>	1	<input type="checkbox"/>	All	<input type="checkbox"/>
4	<input type="checkbox"/>	1	<input type="checkbox"/>	All	<input type="checkbox"/>
5	<input type="checkbox"/>	1	<input type="checkbox"/>	All	<input type="checkbox"/>
6	<input type="checkbox"/>	1	<input type="checkbox"/>	All	<input type="checkbox"/>
7	<input type="checkbox"/>	1	<input type="checkbox"/>	All	<input type="checkbox"/>
8	<input type="checkbox"/>	1	<input type="checkbox"/>	All	<input type="checkbox"/>
9	<input type="checkbox"/>	1	<input type="checkbox"/>	All	<input type="checkbox"/>
10	<input type="checkbox"/>	100	<input type="checkbox"/>	All	<input type="checkbox"/>
11	<input type="checkbox"/>	1	<input type="checkbox"/>	All	<input type="checkbox"/>
12	<input type="checkbox"/>	1	<input type="checkbox"/>	All	<input type="checkbox"/>
13	<input type="checkbox"/>	1	<input type="checkbox"/>	All	<input type="checkbox"/>
14	<input type="checkbox"/>	1	<input type="checkbox"/>	All	<input type="checkbox"/>

Step 3, we need to create separate VLANs for different Clients. In the **ES-3124**, in the **Advanced Application**, click **Multicast** to enter the **Multicast Setting** and configure the MVR VLAN=100. Define port 14, port 15 and port 16 as the receiver ports to forward multicast stream to clients in different VLANs; set port 22 as a source port to receive traffic from the media server. Also, we select mode as *dynamic* mode. The switch sends IGMP report message to multicast router through its source port.

Figure 6 MVR Configuration

MVR
Multicast Setting [Group Configuration](#)

Active

Name

Multicast VLAN ID

Mode Dynamic Compatible

Port	Source Port	Receiver Port	None	Tagging
1	<input type="radio"/>	<input type="radio"/>	<input checked="" type="radio"/>	<input type="checkbox"/>
2	<input type="radio"/>	<input type="radio"/>	<input checked="" type="radio"/>	<input type="checkbox"/>
3	<input type="radio"/>	<input type="radio"/>	<input checked="" type="radio"/>	<input type="checkbox"/>
4	<input type="radio"/>	<input type="radio"/>	<input checked="" type="radio"/>	<input type="checkbox"/>
5	<input type="radio"/>	<input type="radio"/>	<input checked="" type="radio"/>	<input type="checkbox"/>
6	<input type="radio"/>	<input type="radio"/>	<input checked="" type="radio"/>	<input type="checkbox"/>
7	<input type="radio"/>	<input type="radio"/>	<input checked="" type="radio"/>	<input type="checkbox"/>
8	<input type="radio"/>	<input type="radio"/>	<input checked="" type="radio"/>	<input type="checkbox"/>
9	<input type="radio"/>	<input type="radio"/>	<input checked="" type="radio"/>	<input type="checkbox"/>
10	<input type="radio"/>	<input type="radio"/>	<input checked="" type="radio"/>	<input type="checkbox"/>
11	<input type="radio"/>	<input type="radio"/>	<input checked="" type="radio"/>	<input type="checkbox"/>
12	<input type="radio"/>	<input type="radio"/>	<input checked="" type="radio"/>	<input type="checkbox"/>
13	<input type="radio"/>	<input type="radio"/>	<input checked="" type="radio"/>	<input type="checkbox"/>
14	<input type="radio"/>	<input checked="" type="radio"/>	<input type="radio"/>	<input type="checkbox"/>
15	<input type="radio"/>	<input checked="" type="radio"/>	<input type="radio"/>	<input type="checkbox"/>
16	<input type="radio"/>	<input checked="" type="radio"/>	<input type="radio"/>	<input type="checkbox"/>
17	<input type="radio"/>	<input type="radio"/>	<input checked="" type="radio"/>	<input type="checkbox"/>
18	<input type="radio"/>	<input type="radio"/>	<input checked="" type="radio"/>	<input type="checkbox"/>
19	<input type="radio"/>	<input type="radio"/>	<input checked="" type="radio"/>	<input type="checkbox"/>
20	<input type="radio"/>	<input type="radio"/>	<input checked="" type="radio"/>	<input type="checkbox"/>
21	<input type="radio"/>	<input type="radio"/>	<input checked="" type="radio"/>	<input type="checkbox"/>
22	<input checked="" type="radio"/>	<input type="radio"/>	<input type="radio"/>	<input checked="" type="checkbox"/>
23	<input type="radio"/>	<input type="radio"/>	<input checked="" type="radio"/>	<input type="checkbox"/>
24	<input type="radio"/>	<input type="radio"/>	<input checked="" type="radio"/>	<input type="checkbox"/>
25	<input type="radio"/>	<input type="radio"/>	<input checked="" type="radio"/>	<input type="checkbox"/>
26	<input type="radio"/>	<input type="radio"/>	<input checked="" type="radio"/>	<input type="checkbox"/>
27	<input type="radio"/>	<input type="radio"/>	<input checked="" type="radio"/>	<input type="checkbox"/>
28	<input type="radio"/>	<input type="radio"/>	<input checked="" type="radio"/>	<input type="checkbox"/>

Step 4: In the **ES-3124**, after the MVR configuration, click the **Advanced Application** to browse the **VLAN Status** and see we have add a new VLAN 100 in the VLAN list. We also create three separate VLANs, 20, 30, 40 and assign their PVID as 20, 30 and 40 respectively.

Figure 7 VLAN Status

VLAN Status		VLAN Port Setting														Static VLAN	
The Number Of VLAN = 5		Port Number														Elapsed Time	Status
Index	VID	2	4	6	8	10	12	14	16	18	20	22	24	26	28		
1	1	U	U	U	U	U	U	U	U	U	U	U	U	U	U	0:00:05	Static
2	20	-	U	-	-	-	-	U	-	-	-	-	-	-	-		
3	30	-	-	-	-	-	-	-	-	-	-	-	-	-	-	0:00:05	Static
4	40	-	-	U	-	-	-	-	U	-	-	-	-	-	-		
5	100	-	-	-	-	-	-	U	U	-	-	T	-	-	-	0:00:05	Other
		-	-	-	-	-	-	-	U	-	-	-	-	-	-		

Figure 8 VLAN Port Setting

Port	Ingress Check	PVID	GVRP	Acceptable Frame Type	VLAN Trunking
1	<input type="checkbox"/>	1	<input type="checkbox"/>	All	<input type="checkbox"/>
2	<input type="checkbox"/>	1	<input type="checkbox"/>	All	<input type="checkbox"/>
3	<input type="checkbox"/>	1	<input type="checkbox"/>	All	<input type="checkbox"/>
4	<input type="checkbox"/>	20	<input type="checkbox"/>	All	<input type="checkbox"/>
5	<input type="checkbox"/>	30	<input type="checkbox"/>	All	<input type="checkbox"/>
6	<input type="checkbox"/>	40	<input type="checkbox"/>	All	<input type="checkbox"/>
7	<input type="checkbox"/>	1	<input type="checkbox"/>	All	<input type="checkbox"/>
8	<input type="checkbox"/>	1	<input type="checkbox"/>	All	<input type="checkbox"/>
9	<input type="checkbox"/>	1	<input type="checkbox"/>	All	<input type="checkbox"/>
10	<input type="checkbox"/>	1	<input type="checkbox"/>	All	<input type="checkbox"/>
11	<input type="checkbox"/>	1	<input type="checkbox"/>	All	<input type="checkbox"/>
12	<input type="checkbox"/>	1	<input type="checkbox"/>	All	<input type="checkbox"/>
13	<input type="checkbox"/>	1	<input type="checkbox"/>	All	<input type="checkbox"/>
14	<input type="checkbox"/>	20	<input type="checkbox"/>	All	<input type="checkbox"/>
15	<input type="checkbox"/>	30	<input type="checkbox"/>	All	<input type="checkbox"/>
16	<input type="checkbox"/>	40	<input type="checkbox"/>	All	<input type="checkbox"/>
17	<input type="checkbox"/>	1	<input type="checkbox"/>	All	<input type="checkbox"/>
18	<input type="checkbox"/>	1	<input type="checkbox"/>	All	<input type="checkbox"/>

Step 5: Before we start to use the MVR, it is quite fundamental to enable the IGMP Snooping first. In the **ES-3124 Menu**, click the **Multicast** and go to the **Multicast Setting**, activate the **IGMP Snooping**.

Figure 10 Multicast Setting

Multicast Setting		Multicast Status	IGMP Filtering Profile	MVR
IGMP Snooping	Active	<input checked="" type="checkbox"/>		
IGMP Filtering	Active	<input type="checkbox"/>		
Unknown Multicast Frame	<input type="radio"/> Flooding <input checked="" type="radio"/> Drop			

Port	Immed. Leave	Group Limited	Max Group Num.	IGMP Filtering Profile
1	<input type="checkbox"/>	<input type="checkbox"/>	0	Default
2	<input type="checkbox"/>	<input type="checkbox"/>	0	Default
3	<input type="checkbox"/>	<input type="checkbox"/>	0	Default
4	<input type="checkbox"/>	<input type="checkbox"/>	0	Default
5	<input type="checkbox"/>	<input type="checkbox"/>	0	Default
6	<input type="checkbox"/>	<input type="checkbox"/>	0	Default
7	<input type="checkbox"/>	<input type="checkbox"/>	0	Default
8	<input type="checkbox"/>	<input type="checkbox"/>	0	Default
9	<input type="checkbox"/>	<input type="checkbox"/>	0	Default
10	<input type="checkbox"/>	<input type="checkbox"/>	0	Default
11	<input type="checkbox"/>	<input type="checkbox"/>	0	Default
12	<input type="checkbox"/>	<input type="checkbox"/>	0	Default

Step 6: In the **ES-3124**, in the **advanced application**, select **Multicast**, and then in the **Multicast setting**, and choose **MVR** and click the **Group configuration**. Here, we configure 233.1.1.1~ 233.1.1.100 as the range of multicast address and only the clients belong to that range of multicast group will receive the multicast traffic.

Figure 11 Group Configuration

Group Configuration			MVR
Multicast VLAN ID	100		

Name	Start Address	End Address
<input type="text"/>	0.0.0.0	0.0.0.0

MVLAN	Name	Start Address	End Address	Delete All	Delete Group
100	Test	233.1.1.1	233.1.1.100	<input type="checkbox"/>	<input type="checkbox"/>

Configuration via CLI

Step 1: On the ES-3124, in the configure mode, create VLAN 100

```
ES-3124# config
ES-3124(config)# vlan 100
```

Step 2: In the VLAN 100, set the port 22 to be fixed port.

```
ES-3124(config-vlan)# fixed 22
```

Step 3: On the ES-3124, in the configure mode, create VLAN 20, and set the port 4 and port 14 to be fixed port.

```
ES-3124(config)# vlan 20
ES-3124(config-vlan)# untagged 4
ES-3124(config-vlan)# fixed 4
ES-3124(config-vlan)# untagged 14
ES-3124(config-vlan)# fixed 14
```

Step 4: On the ES-3124, in the configure mode, create VLAN 30, and set the port 5 and port 15 to be fixed port.

```
ES-3124(config)# vlan 30
ES-3124(config-vlan)# untagged 5
ES-3124(config-vlan)# fixed 5
ES-3124(config-vlan)# untagged 15
ES-3124(config-vlan)# fixed 15
```

Step 5: On the ES-3124, in the configure mode, create VLAN 40, and set the port 6 and port 16 to be fixed port.

```
ES-3124(config)# vlan 40
ES-3124(config-vlan)# untagged 6
ES-3124(config-vlan)# fixed 6
ES-3124(config-vlan)# untagged 16
ES-3124(config-vlan)# fixed 16
```

Step 6: On the ES-3124, set the PVID of specific VLAN 20

```
ES-3124(config)# interface port-channel 4
```

```
ES-3124(config-interface)# pvid 20
ES-3124(config-interface)# exit
ES-3124(config)# interface port-channel 14
ES-3124(config-interface)# pvid 20
```

Step 7: On the ES-3124, set the PVID of specific VLAN 30

```
ES-3124(config)# interface port-channel 5
ES-3124(config-interface)# pvid 30
ES-3124(config-interface)# exit
ES-3124(config)# interface port-channel 15
ES-3124(config-interface)# pvid 30
```

Step 8: On the ES-3124, set the PVID of specific VLAN 40

```
ES-3124(config)# interface port-channel 6
ES-3124(config-interface)# pvid 40
ES-3124(config-interface)# exit
ES-3124(config)# interface port-channel 16
ES-3124(config-interface)# pvid 40
```

Step 9: On the ES-3124, in the configure mode, enable IGMP snooping

```
ES-3124(config)# igmpsnooping
```

Step 10: On the ES-3124, in the configure mode, create MVR

```
ES-3124(config)# mvr 100
```

Step 11: Define the Dynamic mode

```
ES-3124(config-mvr)# mode dynamic
```

Step 12: on the ES-3124, in the MVR 100, set up the multicast group address.

```
ES-3124(config-mvr)# group test start-address 233.1.1.1
end-address 233.1.1.100
```

Step 13: In the MVR 100, specify receiver ports on port 14~16 as tagged ports

```
ES-3124(config-mvr)# receiver-port 14-16
ES-3124(config-mvr)# untagged 14-16
```

Step 14: Then, specify the source port 22 and assign it to be tagged ports

```
ES-3124(config-mvr)# source-port 22
```

```
ES-3124(config-mvr)# tagged 22
```

To ring a network by building redundant links and connections between Switch

What is Spanning Tree Protocol

- **Spanning Tree Overview**

Spanning-Tree Protocol (STP) is a Layer 2 protocol designed to run on bridges and switches. The specification for STP is defined in IEEE 802.1d. The main purpose of STP is to ensure that you do not run into a loop situation when you have redundant paths in your network. STP detects/disables network loops and provides backup links between switches or bridges. It allows the device to interact with other STP compliant devices in your network to ensure that only one path exists between any two stations on the network.

The redundant topology without STP will cause the following problem:

1. Broadcast storm:

Without Spanning Tree loop avoidance mechanism, each switch will endlessly flood broadcast packets to all ports. This situation is called broadcast storm.

1. When Host sends a broadcast frame, like an ARP request to Router, the frame will be received by Switch A.
2. Switch A identify the destination MAC address field (broadcast FF:FF:FF:FF:FF:FF) in the frame and determine to flood it onto Segment B.
3. When the broadcast frame arrives at Switch B, Switch will repeat above process, flood it to Segment A.
4. The broadcast frame will endlessly travel around the loop network even Router has already received this frame.

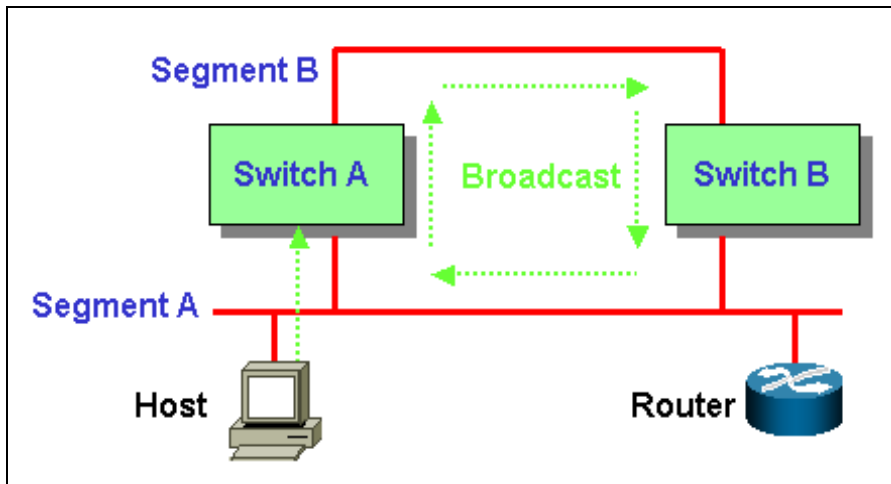

2. Filtering Database Instability:

When multiple copies of a frame arrive at different ports of a switch, the MAC entry instability in Filtering Database will occur.

1. Host sends an unicast frame to Router (source MAC address is Host's MAC, destination MAC address is Router's MAC). Both Switch A and Switch B will receive this frame and learn MAC address of Host on Port 2.
2. Switch A has not yet learned the MAC address of Router. So Switch A will flood a copy of the received frame to Segment B.
3. When the copy of the frame from Switch A arrives at Switch B, Switch B will remove the first entry (Host MAC address on Port 2) in Filtering Database and add a new mapping of Host MAC address on Port 1. Switch B incorrectly learn Host MAC address on Port 1. Switch B can't forward frames properly because the instability of mapping MAC address to Port.

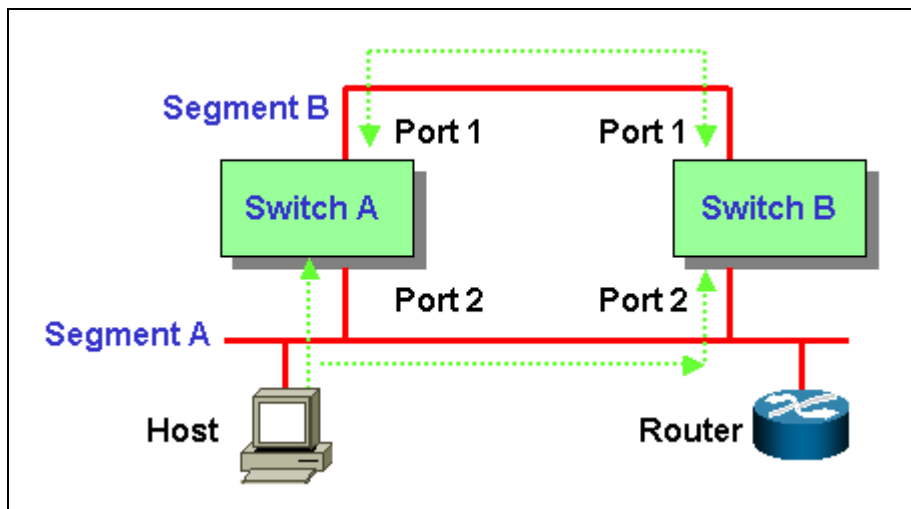

How STP Works

Spanning Tree provide a loop-free network. When a switch supported STP recognize a loop in the network topology, it blocks one or more redundant ports. Spanning Tree Protocol continually explore the network, so when the network topology changes, STP automatically reconfigure switch ports to avoid the failure by blocking certain port.

Spanning tree algorithm aware switches (bridges) exchange configuration messages periodically. The configuration message is a multicast frame called BPDU (Bridge Protocol Data Unit) or Hello message. According to BPDU, these STP aware will construct a loop free network with "tree" architecture.

STP operation is listed as the following:

1. Select a root bridge

Only one switch/ bridge can be selected as the root bridge in a given network. All other decisions in the network, such as which port is blocked and which port is put in forwarding mode, are made regarding this root bridge. The root bridge is the "root" of the constructed "tree".

1. One of the important field included in the BPDU is the bridge ID. Each bridge has unique bridge ID. **The root bridge is the bridge with the lowest bridge ID** in the spanning tree network.

2. The bridge ID includes two parts, bridge priority (2 bytes) and bridge MAC address (6 bytes). The 802.1d default bridge priority is 32768. For example, a switch with default priority 32768 (8000 hex), MAC address is 00:A0:C5:12:34:56, its bridge ID is 8000:00A0:C512:3456.
3. On the root bridge, all its ports are **designated ports**. **Designated ports are always in the forwarding state**. While in forwarding state, a port can receive and send traffic.

2. Select a root port for the non-root bridge

For the non-root switch/bridge, there will be one root port. The root port is the port through which this non-root switch / bridge communicates with the root bridge (the "leaf" side of the "tree").

1. The root port is the port on the non-root bridge with the lowest path cost to the root bridge. **The root port is normally in forwarding state**.
2. Path cost is the total cost of transmitting a frame on to a LAN through that port to bridge root. It is assigned according to the bandwidth of the link. The slower the media, the higher the cost. Some of the path costs specified in the IEEE 802.1d specification are listed below.

Link Speed	Recommended Cost	Recommended Cost Range
4Mbps	250	100 to 1000
10Mbps	100	50 to 600
16Mbps	62	40 to 400
100Mbps	19	10 to 60
1Gbps	4	3 to 10
10Gbps	2	1 to 5

3. When multiple ports have the same path cost to root bridge, **the port with lowest port priority is selected as root port**.

3. Select a designated port on each segment

For each LAN segment (collision domain), there is a designated port. The designated port has the lowest cost to the root bridge. Designated ports are normally in the forwarding state to forward and receive traffic to the segment. If more than one port in the segment have the same path cost, the port on which bridge has lowest bridge ID is selected as a designated port.

1. How STP works

After STP determines the lowest cost spanning tree, it enables all root ports and designated ports, and disables all other ports. Network packets are therefore only forwarded between root ports and designated ports, eliminating any possible network loops. STP-aware devices exchange Bridge Protocol Data Units (BPDUs) periodically. When the bridged LAN topology changes, a new spanning tree is constructed.

Once a stable network topology has been established, all bridges listen for Hello BPDUs (Bridge Protocol Data Units) transmitted from the root bridge. If a bridge does not get a Hello BPDU after a predefined interval (Max Age), the bridge assumes that the link to the root bridge is down. This bridge then initiates negotiations with other bridges to reconfigure the network to re-establish a valid network topology.

For example:

Switch A: MAC = 00A0C5111111, Priority = 32768			Switch B: MAC = 00A0C5222222, Priority = 32768			Switch C: MAC = 00A0C5333333 Priority = 1	
	Port 1	Port 2		Port 1	Port 2		Port 1
Cost	19	100	Cost	19	100	Cost	19
Priority	128	128	Priority	128	128	Priority	128

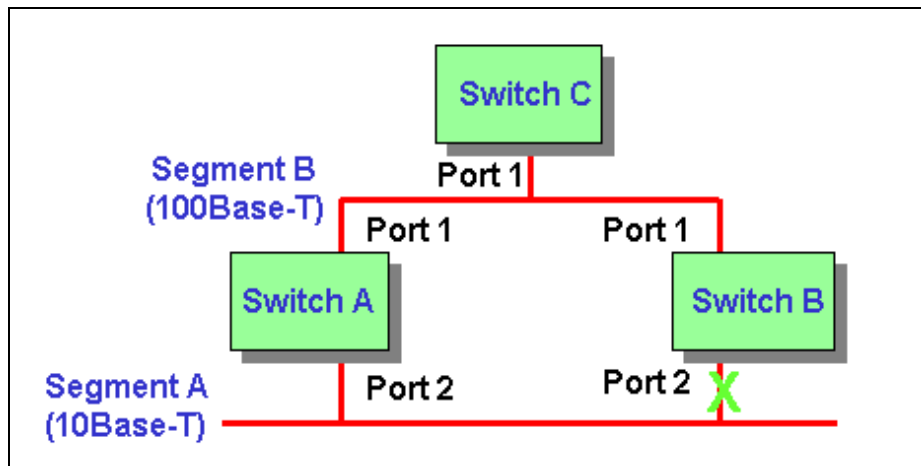

1. Switch A bridge ID = 8000:00A0:C511:1111, Switch B bridge ID = 8000:00A0:C522:2222, Switch C bridge ID = 0001:00A0:C533:3333. Switch C has the lowest bridge ID, so Switch C is the root bridge. All ports of the root bridge are designated ports, so Port 1 is designated port.
2. For non-root bridge Switch A, Port 1 path cost to root bridge is 19, Port 2 path cost is 119, 100 (Switch A Port 2) + 19 (Switch B Port 1). For Switch B, Port 1 path cost is 19, Port 2 path cost is 119. Root port = Port 1 of Switch A and Switch B because it has the lowest path cost to the root bridge Switch C.
3. On Segment A, both Port 2 of Switch A and Switch B have the same path cost to root bridge. Since Switch A has lower bridge ID than Switch B, the designated port is selected on Switch A. So Port 2 of Switch A is designated port.

Blocking = Port 2 of Switch B, the non designated port on the segment.

Forwarding = All designated ports and root ports.

Switching security

MAC freeze

As an added protection against network intrusion attacks, ZyXEL has implemented the MAC Freeze feature on ES-3124, ES-3124PWR, GS-3012 Series and ES-2024A. Security has been the focus of our Ethernet switch design. This feature will also be available for GS-4024, GS-4012F, GS-3012 Series, ES-2024A and new switch models in future firmware releases.

With the MAC freeze feature enabled, dynamic MAC addresses on specified ports are stored in the static MAC address table. At the same time, MAC address learning is disabled on these ports thus denying network access for computers within unknown MAC addresses.

Without the MAC freeze function, any computer can access the network through a switch port. The port automatically learns the computer's MAC address and stores that to the MAC address table.

Activate the MAC freeze function on a port by entering the `port-security [port number] MAC-freeze` command in the CLI.

The following figure shows an example where the MAC freeze feature is enabled on port 6. The switch automatically copies all dynamically learnt MAC address on port 6 to the static MAC address.

Figure 1: Enable MAC Freeze Example

```

Telnet 172.23.3.75
wfq                               Set WFQ method
ES-3124(config)# port-security 6 mac-freeze
Add [port:6 vid:1 mac:00:02:3f:67:17:be] to static forwarding
Add [port:6 vid:1 mac:00:02:e3:4a:af:3c] to static forwarding
Add [port:6 vid:1 mac:00:04:80:9b:78:00] to static forwarding
Add [port:6 vid:1 mac:00:08:02:1f:da:fe] to static forwarding
Add [port:6 vid:1 mac:00:0a:e4:13:7d:04] to static forwarding
Add [port:6 vid:1 mac:00:0a:e4:13:7e:fa] to static forwarding
Add [port:6 vid:1 mac:00:0a:e4:13:7f:d3] to static forwarding
Add [port:6 vid:1 mac:00:0d:60:13:86:81] to static forwarding
Add [port:6 vid:1 mac:00:0d:60:77:1a:f1] to static forwarding
Add [port:6 vid:1 mac:00:0d:60:78:d5:e9] to static forwarding
Add [port:6 vid:1 mac:00:0d:60:80:21:20] to static forwarding
Add [port:6 vid:1 mac:00:0d:60:8f:1c:80] to static forwarding
Add [port:6 vid:1 mac:00:0d:60:cb:3b:b5] to static forwarding
Add [port:6 vid:1 mac:00:0d:60:cb:7a:85] to static forwarding
Add [port:6 vid:1 mac:00:0d:9d:d9:43:4f] to static forwarding
Add [port:6 vid:1 mac:00:0f:20:6f:a9:3c] to static forwarding
Add [port:6 vid:1 mac:00:0f:20:75:09:db] to static forwarding
Add [port:6 vid:1 mac:00:0f:20:75:09:fc] to static forwarding
Add [port:6 vid:1 mac:00:0f:fe:09:c9:97] to static forwarding
Add [port:6 vid:1 mac:00:11:2f:0f:2c:73] to static forwarding
Add [port:6 vid:1 mac:00:13:49:17:45:17] to static forwarding
Add [port:6 vid:1 mac:00:50:8d:36:3b:26] to static forwarding
Add [port:6 vid:1 mac:00:50:8d:af:41:fa] to static forwarding
Add [port:6 vid:1 mac:00:a0:c5:01:23:45] to static forwarding
    
```

You can display the **Static MAC Address** screen in the web configurator to view the copied MAC addresses.

Figure 2: Displaying MAC Addresses From MAC Freeze

Index	Active	Name	MAC Address	VID	Port	Delete
1	Yes	00:02:3f:67:17:be	00:02:3f:67:17:be	1	6	<input type="checkbox"/>
2	Yes	00:02:e3:4a:af:3c	00:02:e3:4a:af:3c	1	6	<input type="checkbox"/>
3	Yes	00:04:80:9b:78:00	00:04:80:9b:78:00	1	6	<input type="checkbox"/>
4	Yes	00:08:02:1f:da:fe	00:08:02:1f:da:fe	1	6	<input type="checkbox"/>
5	Yes	00:0a:e4:13:7d:04	00:0a:e4:13:7d:04	1	6	<input type="checkbox"/>
6	Yes	00:0a:e4:13:7e:fa	00:0a:e4:13:7e:fa	1	6	<input type="checkbox"/>
7	Yes	00:0a:e4:13:7f:d3	00:0a:e4:13:7f:d3	1	6	<input type="checkbox"/>
8	Yes	00:0d:60:13:86:81	00:0d:60:13:86:81	1	6	<input type="checkbox"/>

After you enabled MAC freeze on port 6 using the CLI command, the switch automatically disables MAC address learning on that port. Display the **Port Security** screen to verify this.

Figure 3: Disabled Automatic MAC Address Learning After MAC Freeze

Port Security

Active

Port	Active	Address Learning	Limited Number of Learned MAC Address
1	<input type="checkbox"/>	<input checked="" type="checkbox"/>	<input type="text" value="0"/>
2	<input type="checkbox"/>	<input checked="" type="checkbox"/>	<input type="text" value="0"/>
3	<input type="checkbox"/>	<input checked="" type="checkbox"/>	<input type="text" value="0"/>
4	<input type="checkbox"/>	<input checked="" type="checkbox"/>	<input type="text" value="0"/>
5	<input type="checkbox"/>	<input checked="" type="checkbox"/>	<input type="text" value="0"/>
6	<input checked="" type="checkbox"/>	<input type="checkbox"/>	<input type="text" value="0"/>
7	<input type="checkbox"/>	<input checked="" type="checkbox"/>	<input type="text" value="0"/>
8	<input type="checkbox"/>	<input checked="" type="checkbox"/>	<input type="text" value="0"/>
9	<input type="checkbox"/>	<input checked="" type="checkbox"/>	<input type="text" value="0"/>
10	<input type="checkbox"/>	<input checked="" type="checkbox"/>	<input type="text" value="0"/>
11	<input type="checkbox"/>	<input checked="" type="checkbox"/>	<input type="text" value="0"/>
12	<input type="checkbox"/>	<input checked="" type="checkbox"/>	<input type="text" value="0"/>
13	<input type="checkbox"/>	<input checked="" type="checkbox"/>	<input type="text" value="0"/>
14	<input type="checkbox"/>	<input checked="" type="checkbox"/>	<input type="text" value="0"/>

Setting up Classifier & Policy rule on your Switch

How should I configure if I only allow certain IP address on a certain port to forward its traffic but deny all others?

In the beginning, we need to set up the classifier to group traffic into data flows based on some such as source address, destination address, port number and packet format. In this example, we specify which format of the packet that ES-3124 applies its policy rules. We define three rules. Firstly, we define a classifier that source address is coming from 192.168.1.20; secondly, we specify a classifier that is based on port 2; finally, we define a classifier that is ARP traffic for testing.

After the classification, we need to define the policy rule to ensure that the traffic gets the deserved treatment in the network. Here, we also define three policy rules. The first policy rule is to forward only the traffic from 192.168.1.20. The second policy rule is to discard all the traffic from port 2 on first classifier; and we apply the second policy rule on second classifier. Finally, the last policy rule is set to forward the traffic that is ARP packet format.

Below is the configuration of classifier and policy rule.

Classifier 1

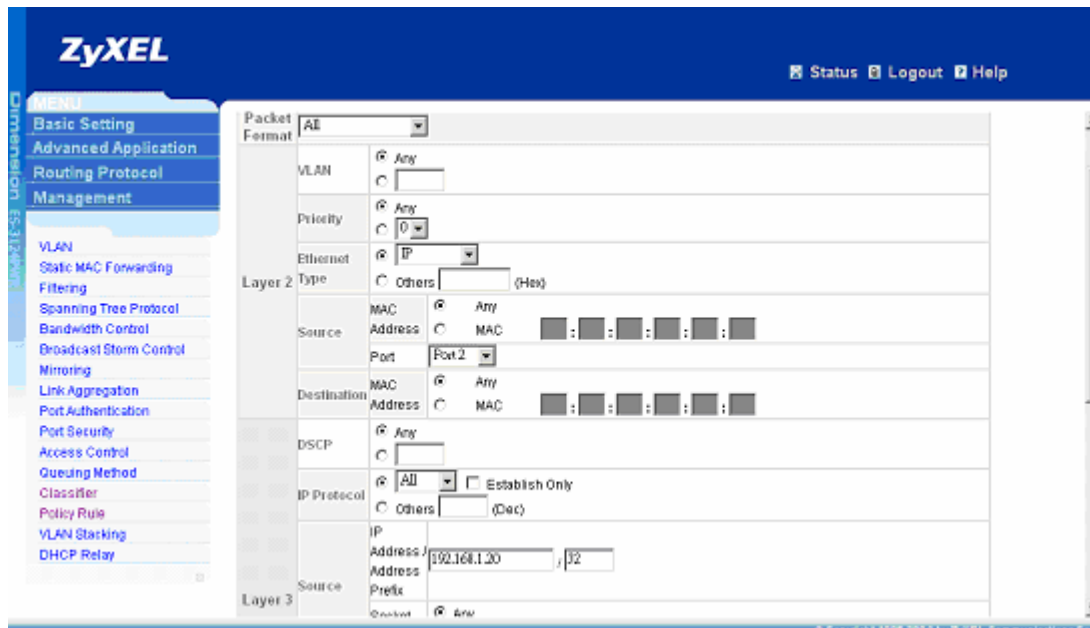

● Classifier 2

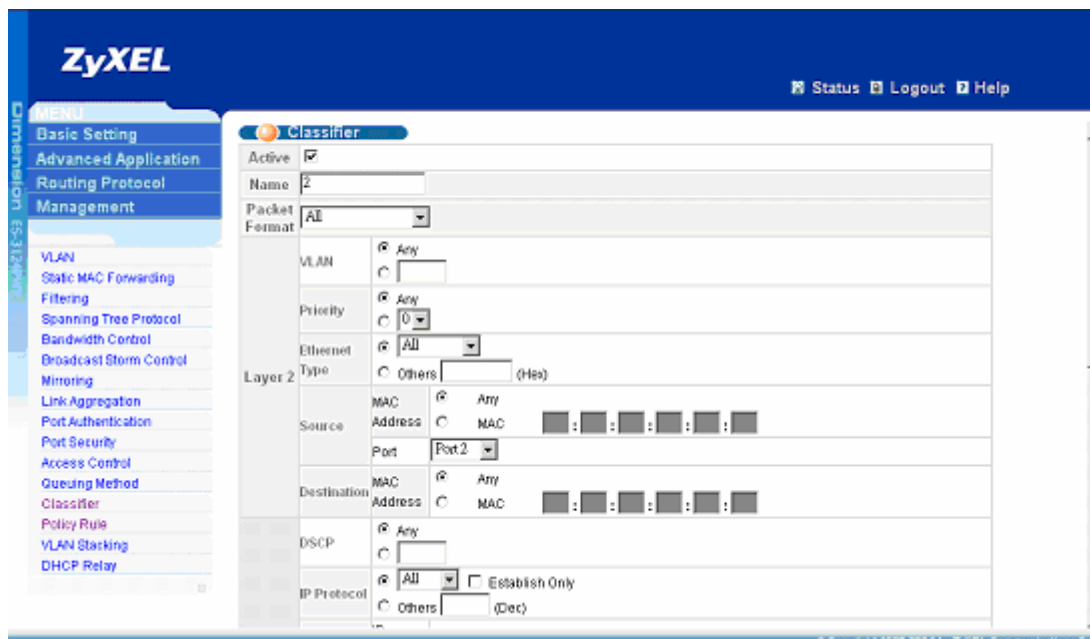

3. Classifier 3

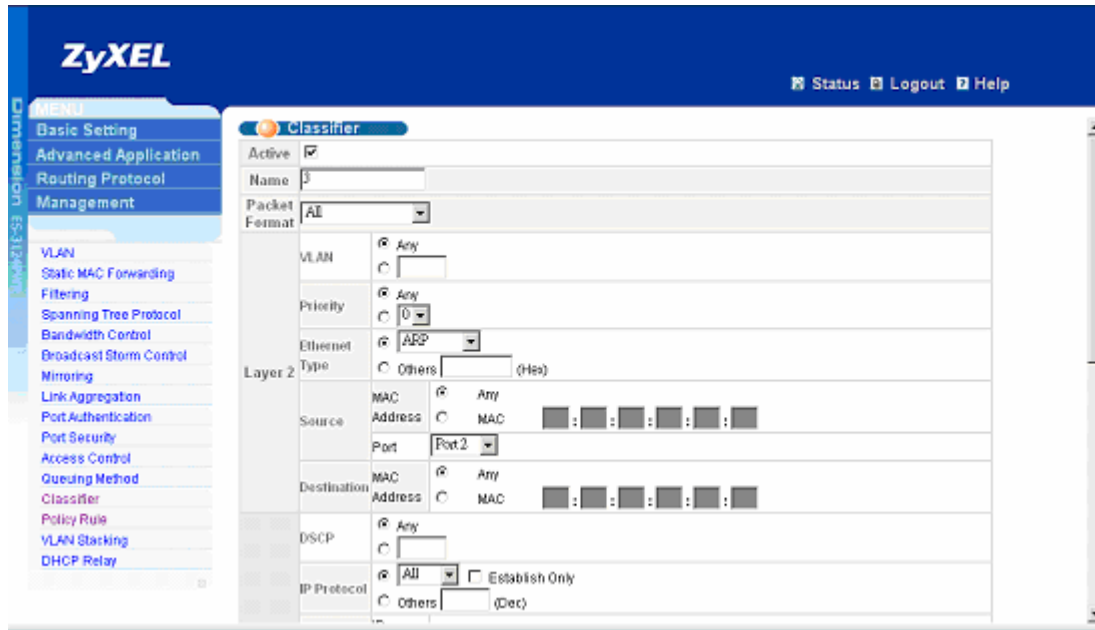

Policy Rule Configuration

1. Policy rule on Classifier 1

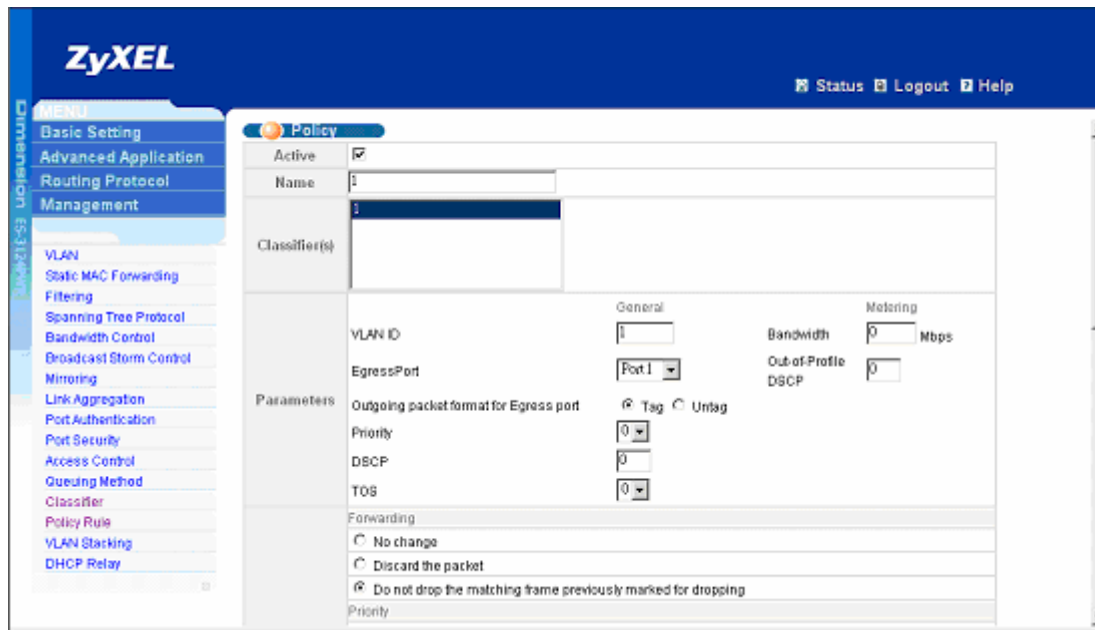

2. Policy rule on classifier 2

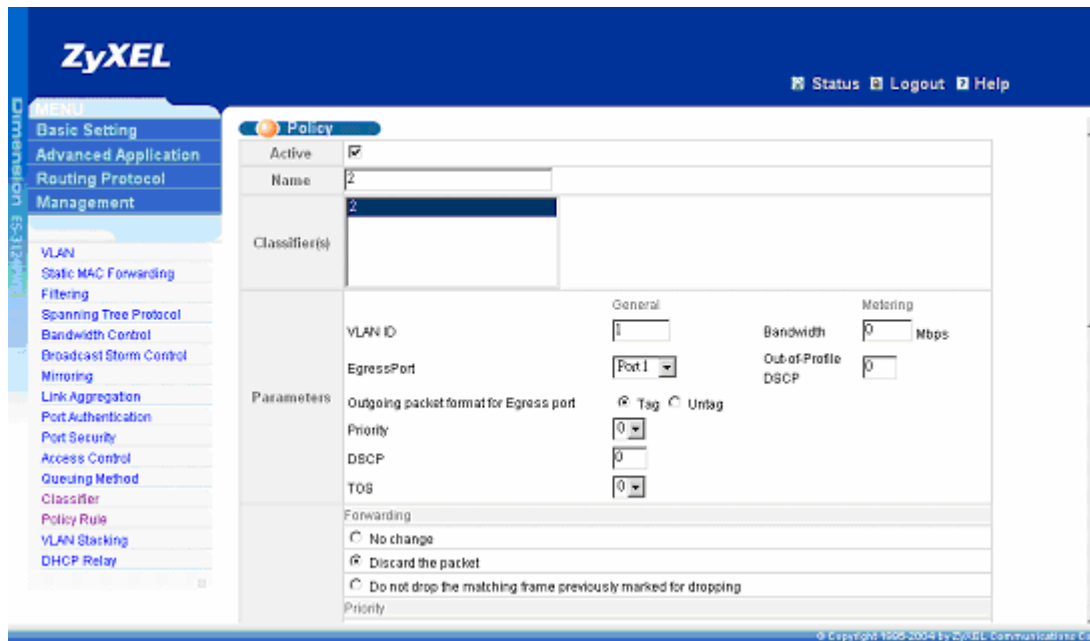

3. Policy rule on classifier 3

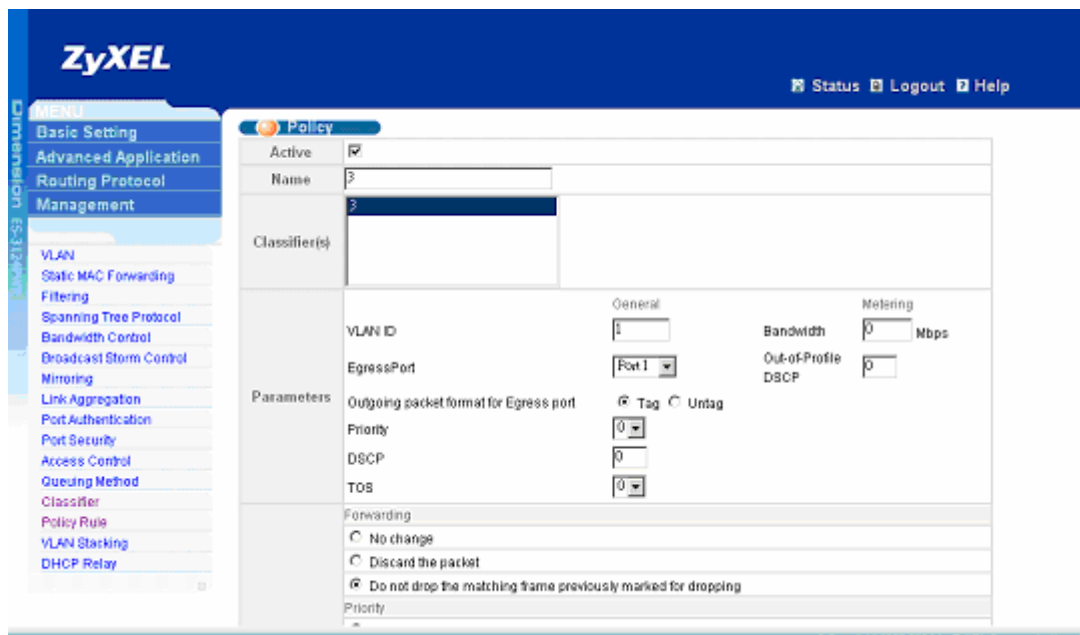

Centralized Management

Introduction of SNMPc and NetAtlas

With the number of network device increase, the demand to detect and respond to the network failure or external event in a very short time posts a great challenge to network administrator. How to easily manage and monitor network devices across networks becomes more and more important in network management.

Figure 1 presents main elements of the system architecture. Element Management System (EMS), NetAtlas provides a centralized remote management platform and acts as SNMPc manager to perform network configuration, system management, event/alarm management, performance management and security for all ZyXEL's Ethernet Switch solutions. SNMPc is network management software produced by Castle Rock that constantly probe the network element (NE) and collect information of those NE for EMS. Underneath the EMS is Postgres SQL, the enterprise relational database system, provides query for EMS

Figure 1 System Architecture

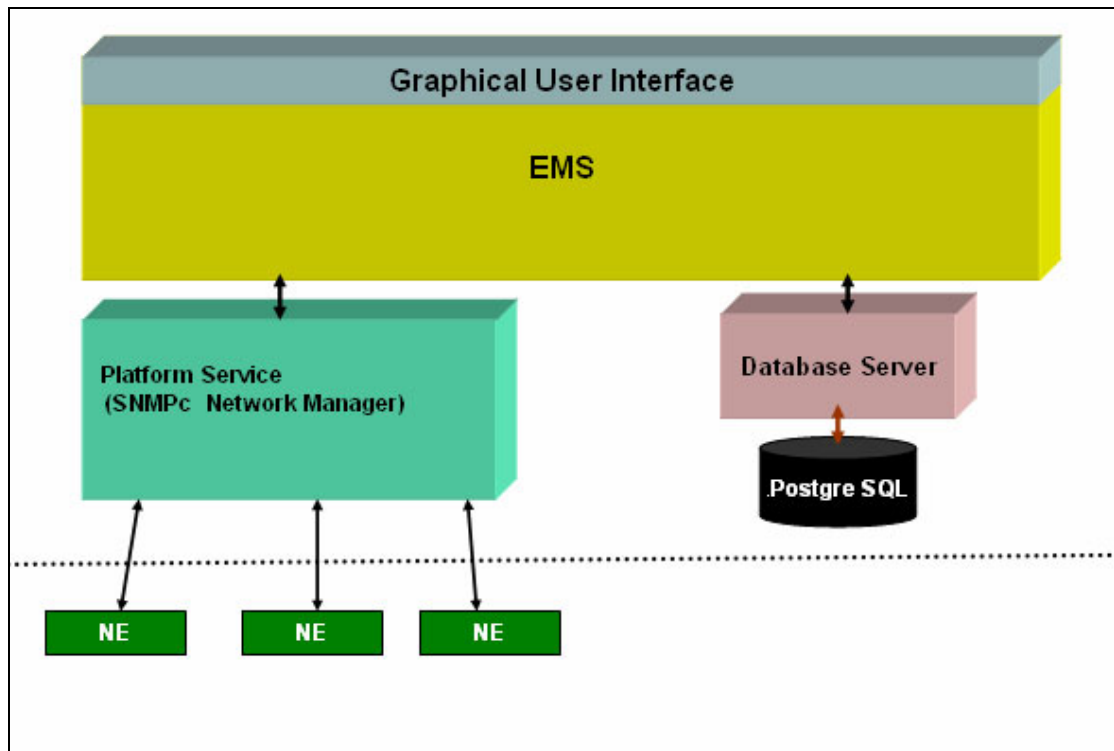

Overview of SNMPc

The following diagram shows the main elements of SNMPc. SNMPc includes the following function

- ◆ **Main Button Bar:** Button and controls to execute commands quickly
- ◆ **Edit Button Bar:** Button to quickly insert map element
- ◆ **Event Log Tool:** Button display filtered event log entries
- ◆ **View Window Area:** Map View, Mib Tables and Mib Graph windows are displayed here.
- ◆ **View Window Area:** Map View, Mib Tables and Mib Graph windows.

Figure 2 Main elements of SNMPc

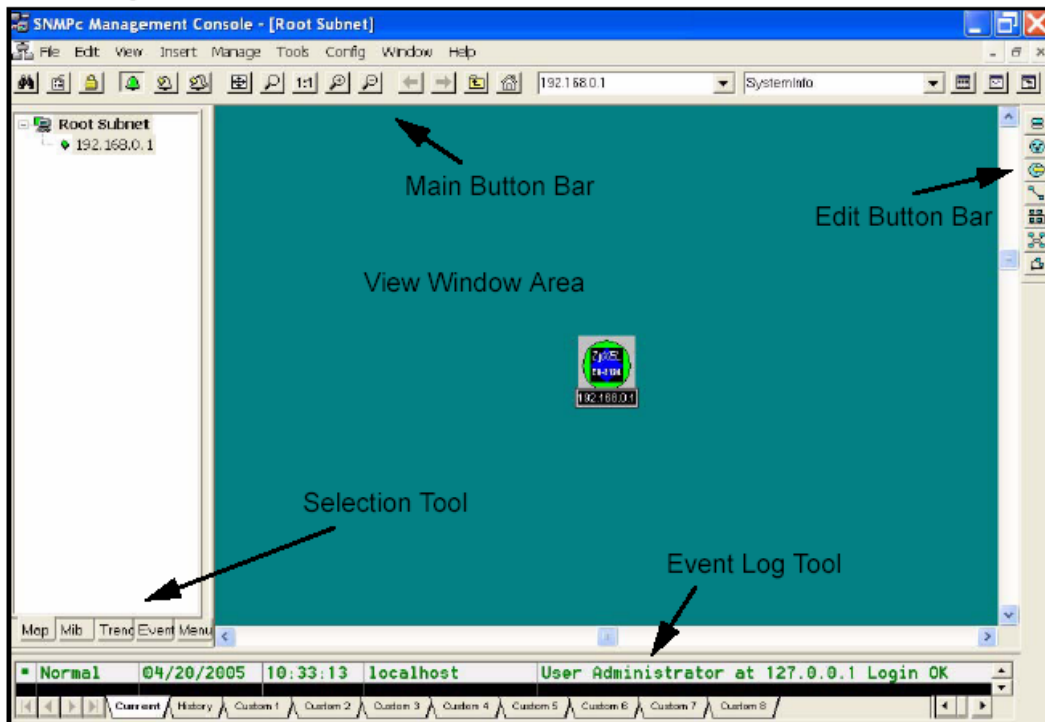

Overview of EMS

The following diagram illustrates the main elements in EMS. EMS contains the four main functions.

- ◆ **Menu Shortcut Bar:** The buttons execute common commands
- ◆ **Device Panel:** This is a graphical device display.
- ◆ **Device List Panel:** View devices in a tree structure. The colors of the device indicate the status of the devices. Green is working and Rd is no response from the device.
- ◆ **System message Panel:** View the alarm Status and port status of the selected switch.

Figure 3 Overview of EMS

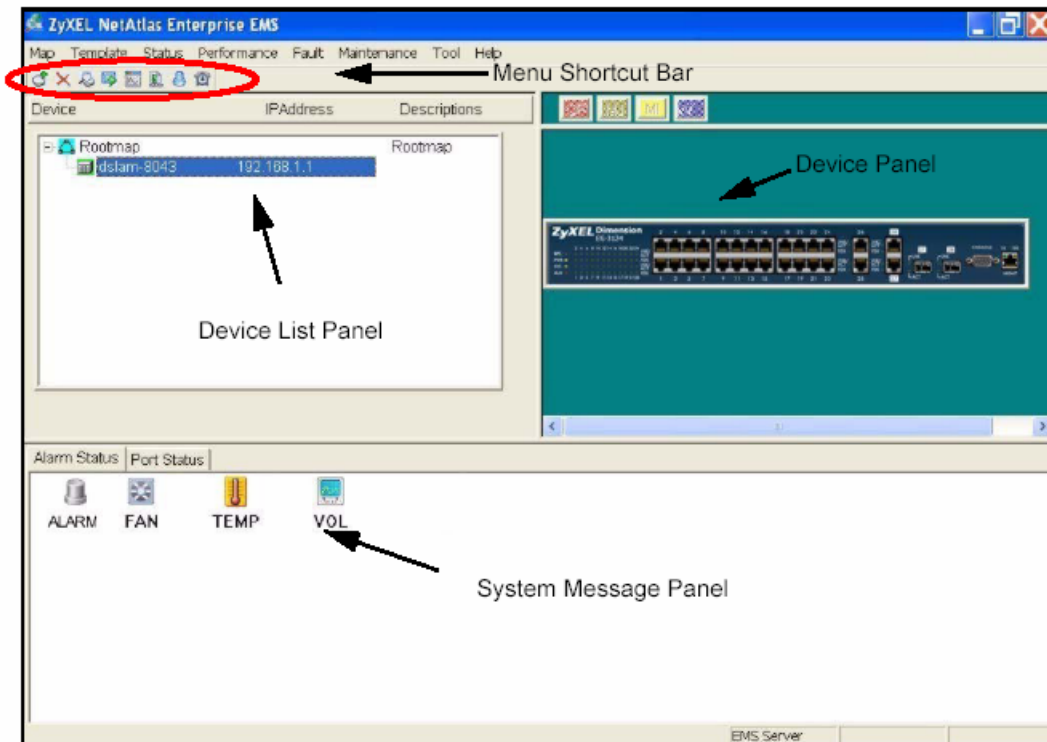

✚ Configuration of adding a new device via SNMPc

In the following example, we will illustrate how to get started with SNMPc and Netatlas with adding a new device. Follow the procedures from Step 1 to Step 11.

Step 1: In the edit button bar shown in the Figure 4 where you may select the icon to insert a new element.

Figure 4 Adding a new Device

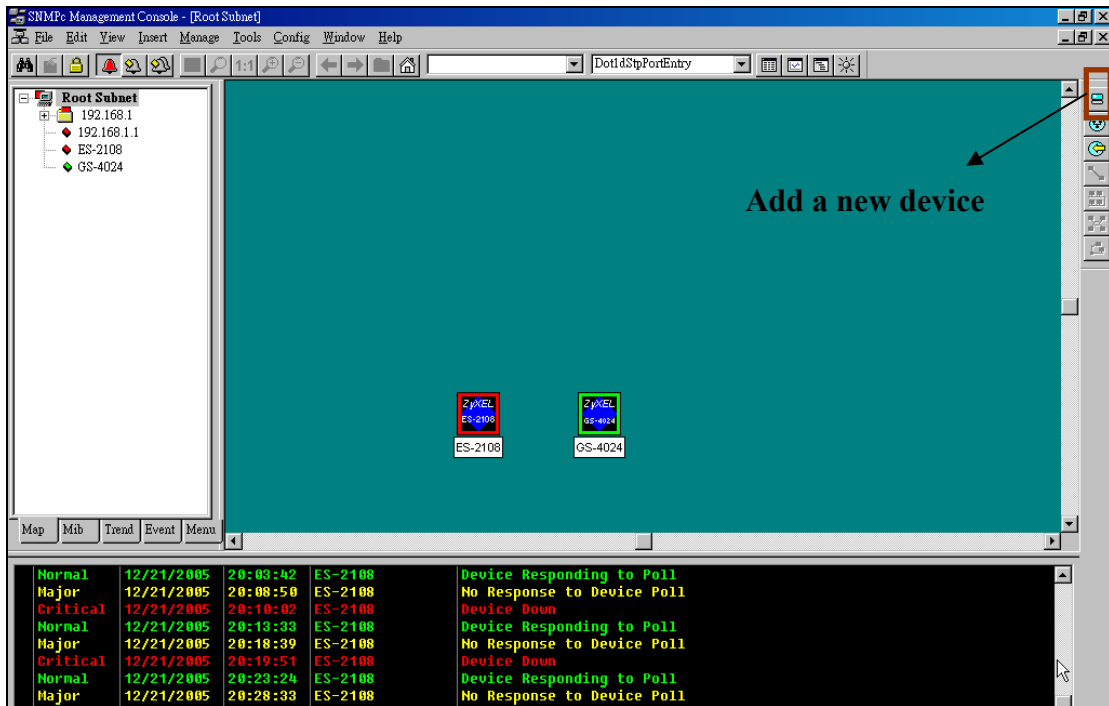

Step 2: In the map object properties, give the label name and enter the IP address of the selected device. In this example, we configure 172.23.3.11 as its IP address of your Switch as shown in Figure 5

Figure 5 Map Object Properties

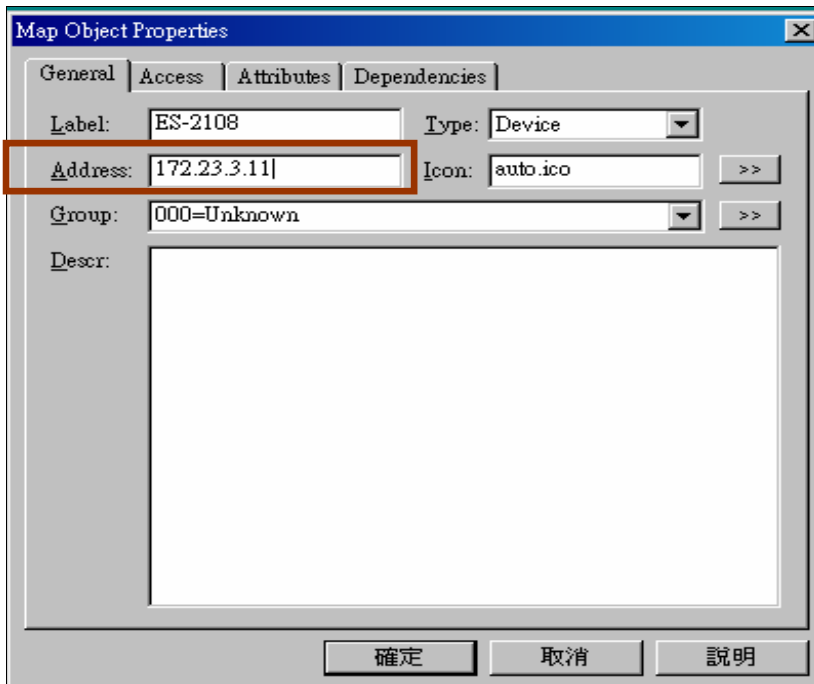

Step 4: In the map object properties, select **Access** tab to set the parameters of Read Access Mode to SNMP V2c shown in Figure 6. Change the value of

Read Access Mode to SNMP V2c.

Figure 6 Read Access mode

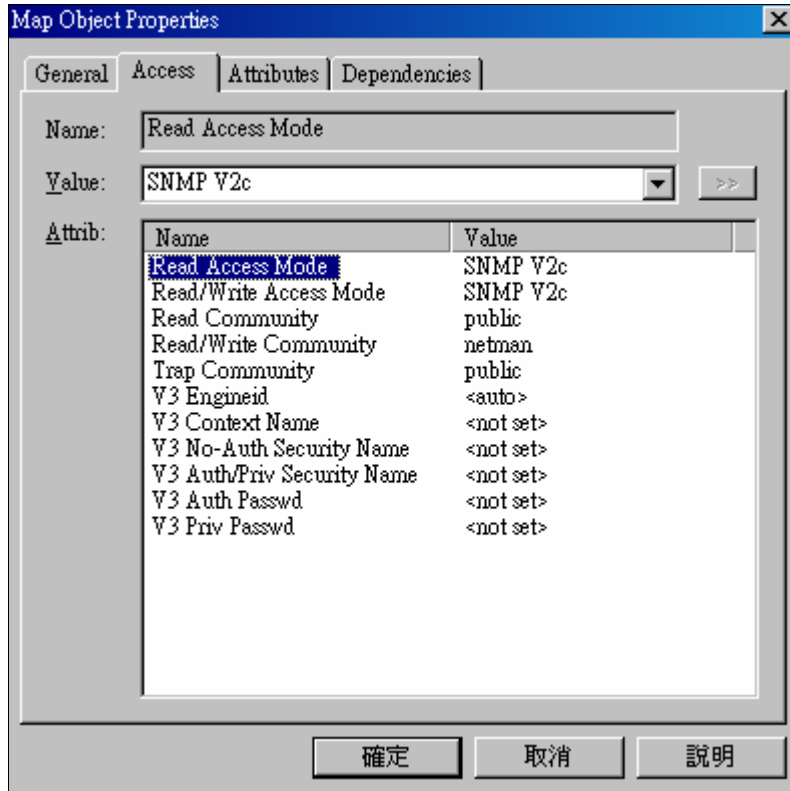

Step 5: In the map object properties, select **Access** tab to set the parameters of Read /Write Access Mode to SNMP V2c shown in Figure 7. Change the value of Read/write Access Mode to SNMP V2c.

Figure 7 Read/Write Access Mode

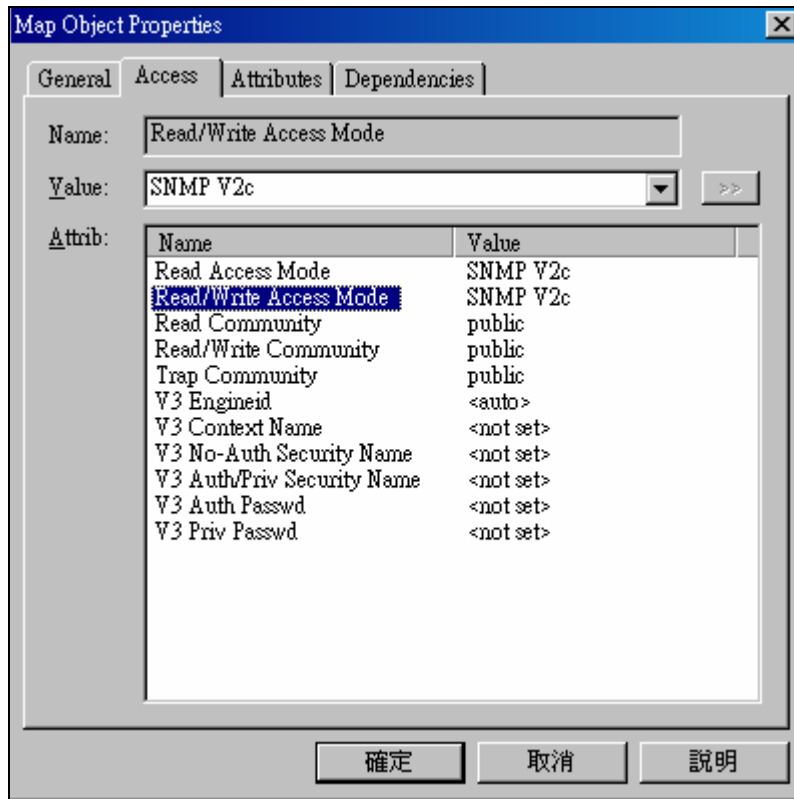

Step 6: In the map object properties, select **Access** tab to set the parameters of Read community to public as shown in Figure 8.

Figure 8 Read Community

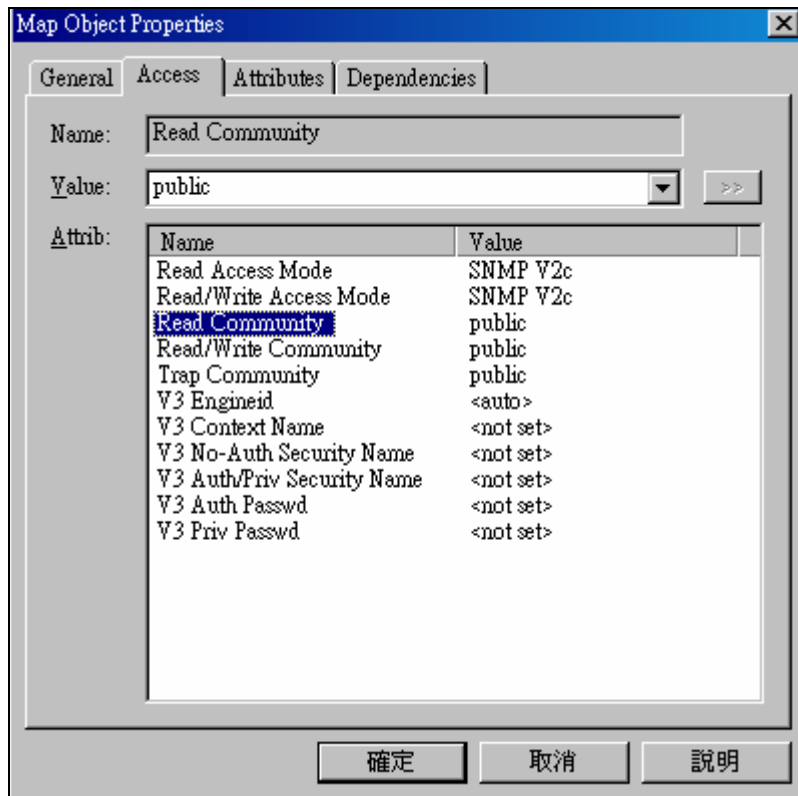

Step 7: In the map object properties, select **Access** tab to set the parameters of Read community to public in Figure 9. Change the value of Read//write Community to Public.

Figure 9 Read/write Community

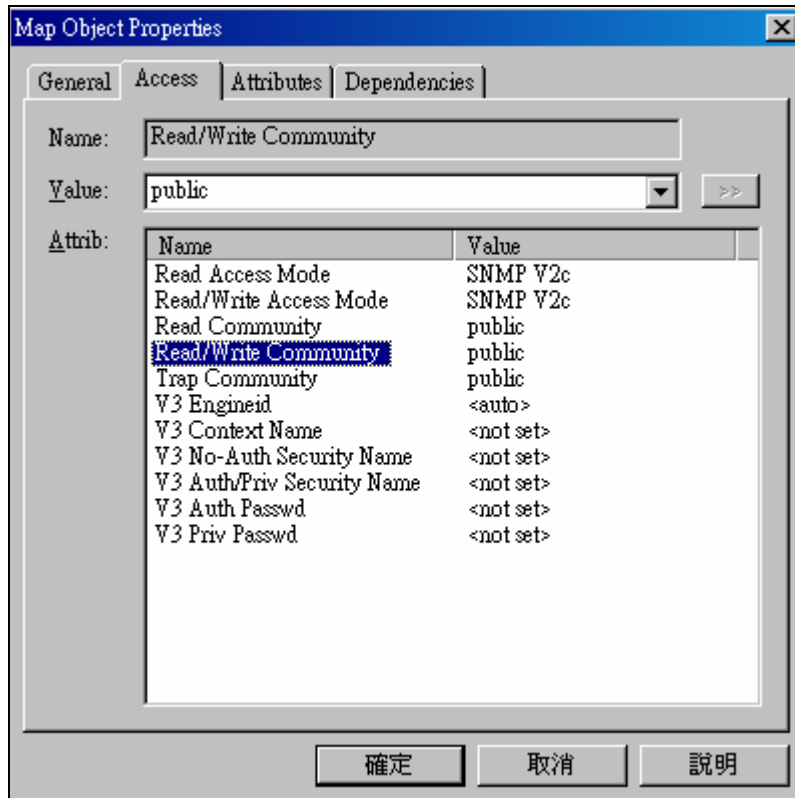

Step 8: In the Selection tool menu, Click the name of your Switch to manage the device.

Figure 10 Device Selection

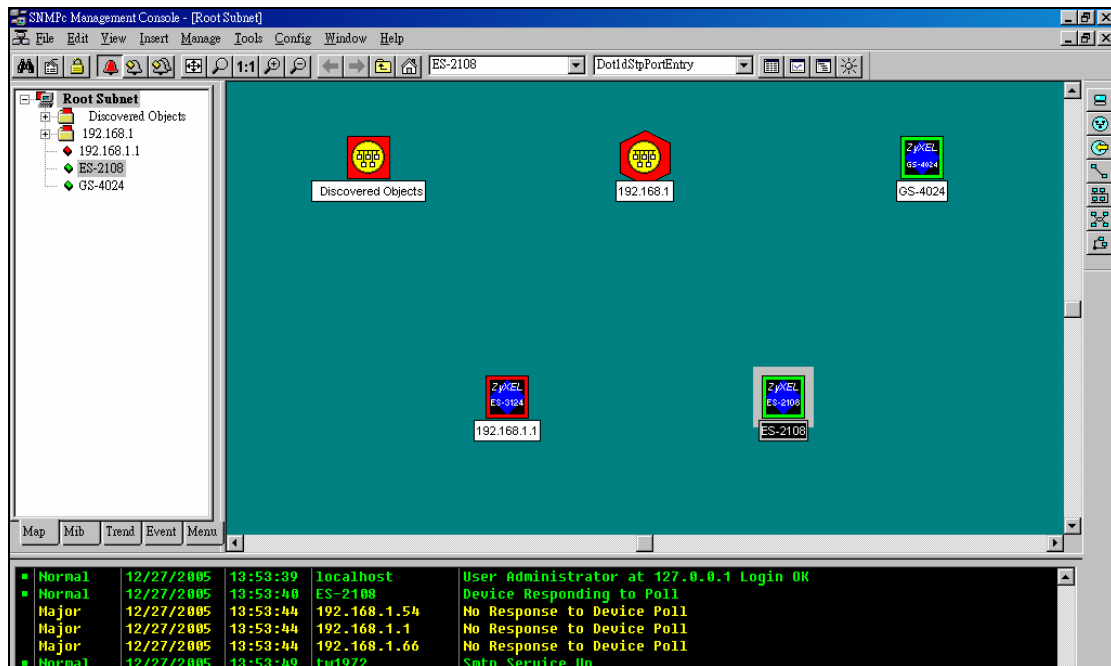

Step 9: After the selection, a pop-up menu will display the NetAtlas switch manager diagram. Click the **Switch Manager** to enter the EMS Mapping shown in Figure 11

Figure 11 Device Selection

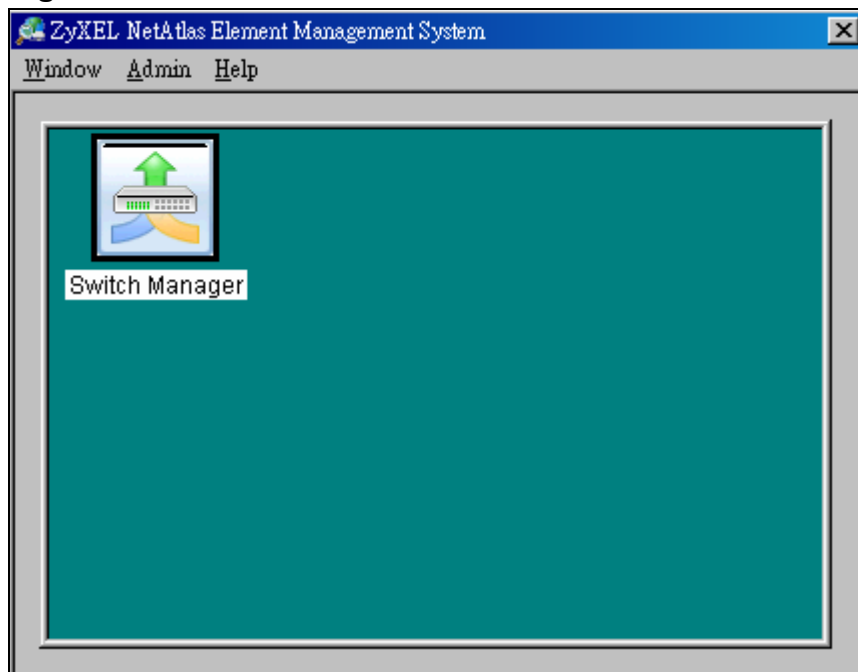

Step 10: In the EMS mapping, it display a logical hierarchy for the device. In the device list, you may see the devices are added in the Rootmap shown in

Figure 12.

Figure 12 Rootmap

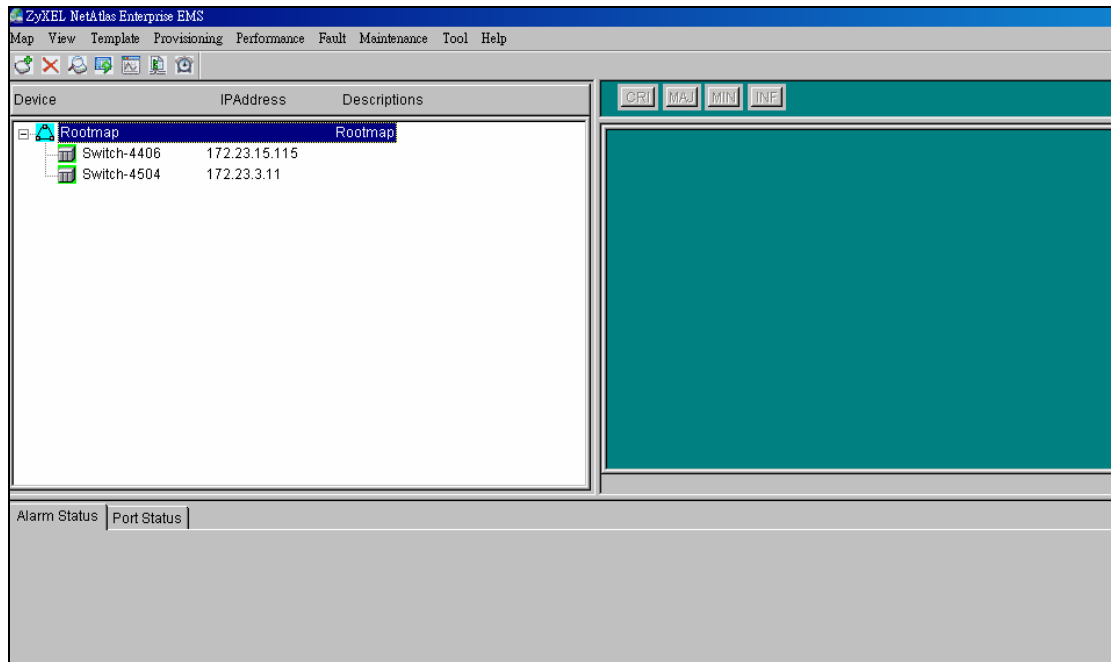

Step 11: Click the your Switch to configure the device shown in Figure 13.

Figure 13 Device mapping

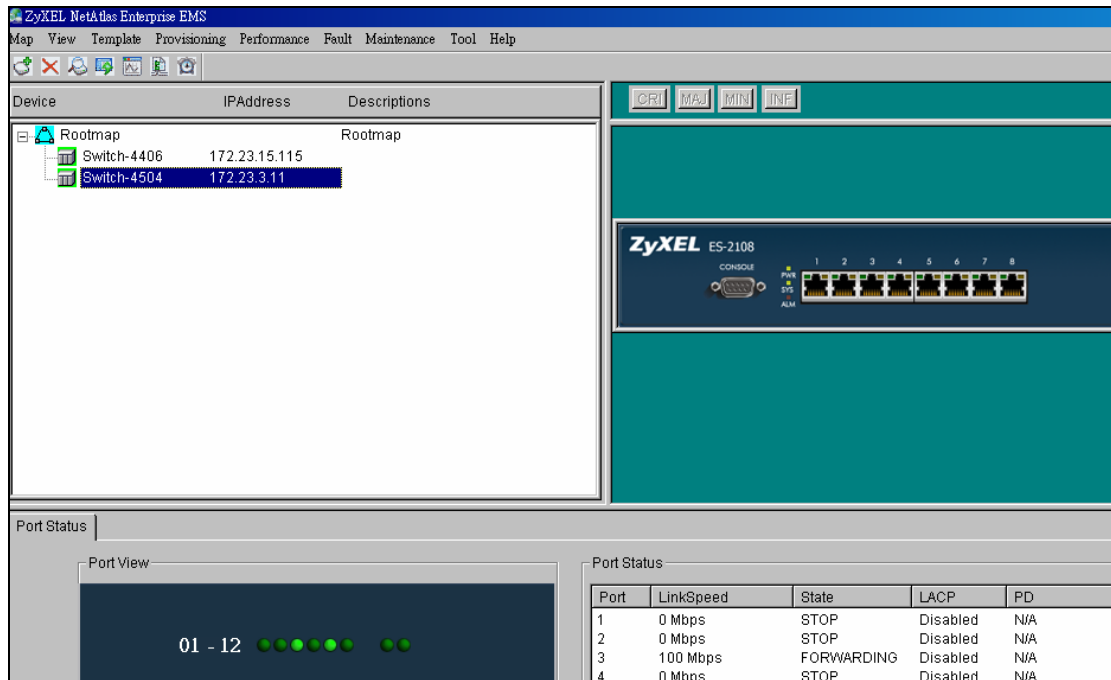

VLAN Configuration via EMS

In this section, we will give an example to illustrate how to use EMS to create a VLAN2 in GS-4024. Here are the procedures.

Step 1: In the device panel list shown in Figure 12, right-click **Configuration**, **Switch Configuration** and then **Switch Setup** tab as shown in Figure 12 and Figure 13.

Step 2: Define the VLAN type, there are two types of VLAN, one is **802.1Q** and the other is **Port-based VLAN**. Select **802.1Q** as the VLAN type and click Apply in the Figure 14.

Figure 12 Device panel list

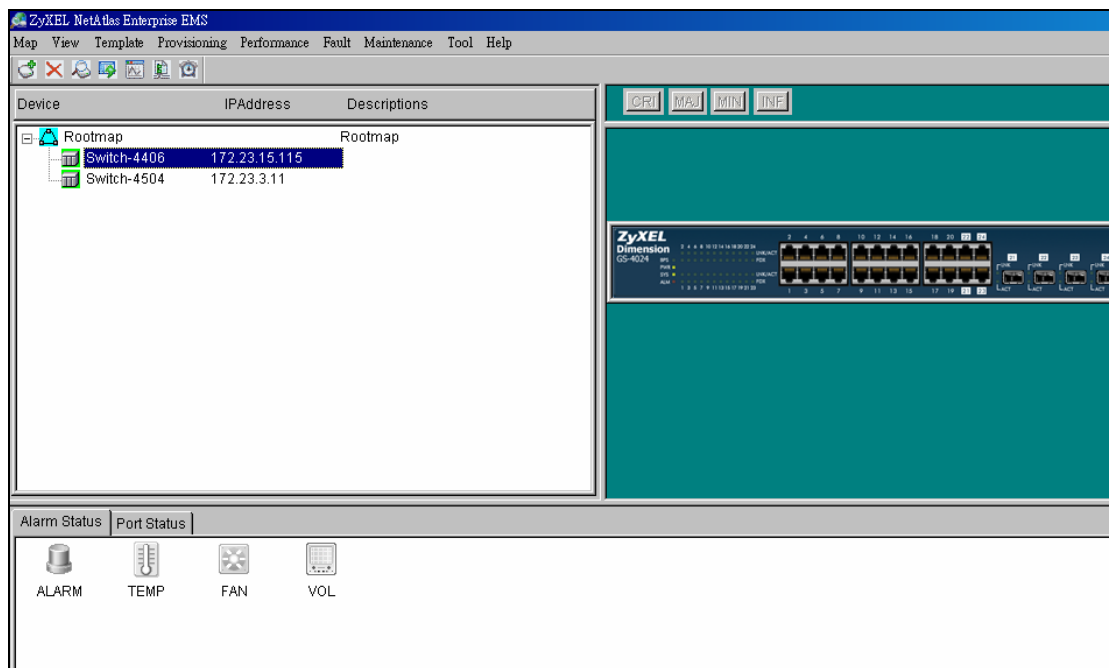

Figure 13 Switch Configuration

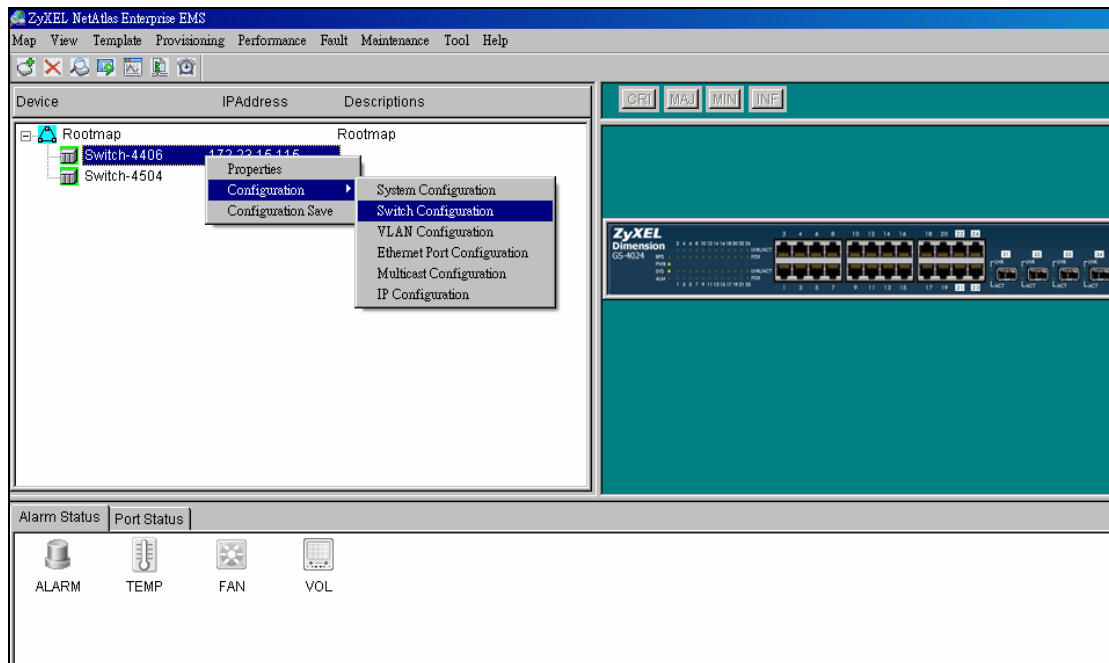
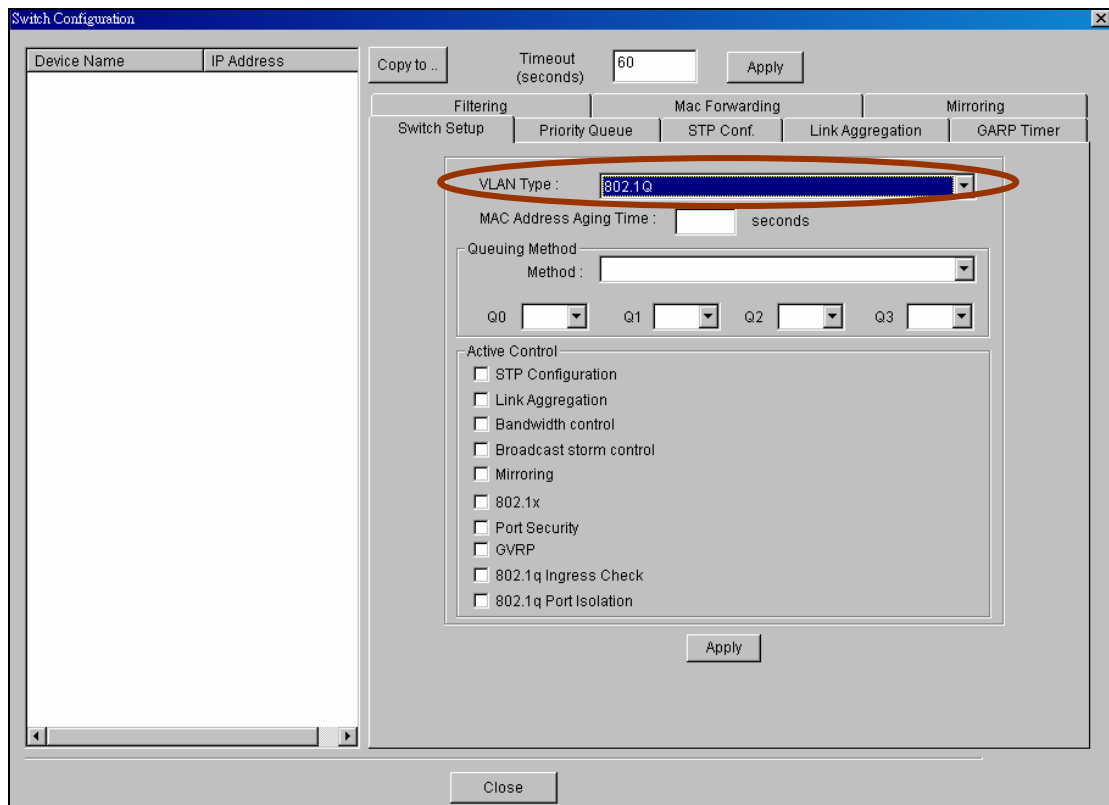

Figure 14 Selecting a VLAN Type



After the VLAN type selection, a pop-up window indicates that you have finished the configuration. Then after we have defined the VLAN type to be the 802.1Q, go back to click the Configuration and then VLAN configuration in

Figure 15.

Figure 15 VLAN Configuration

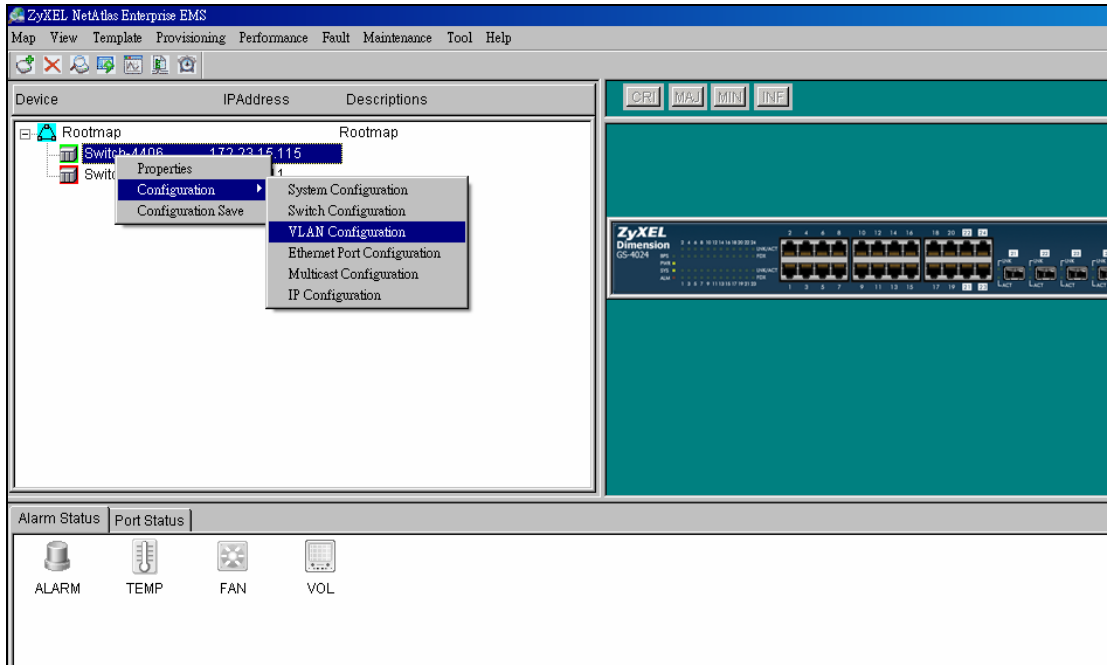

Click the New button to create a new VLAN ID in Figure 16.

Figure 16 Creating a new VLAN ID

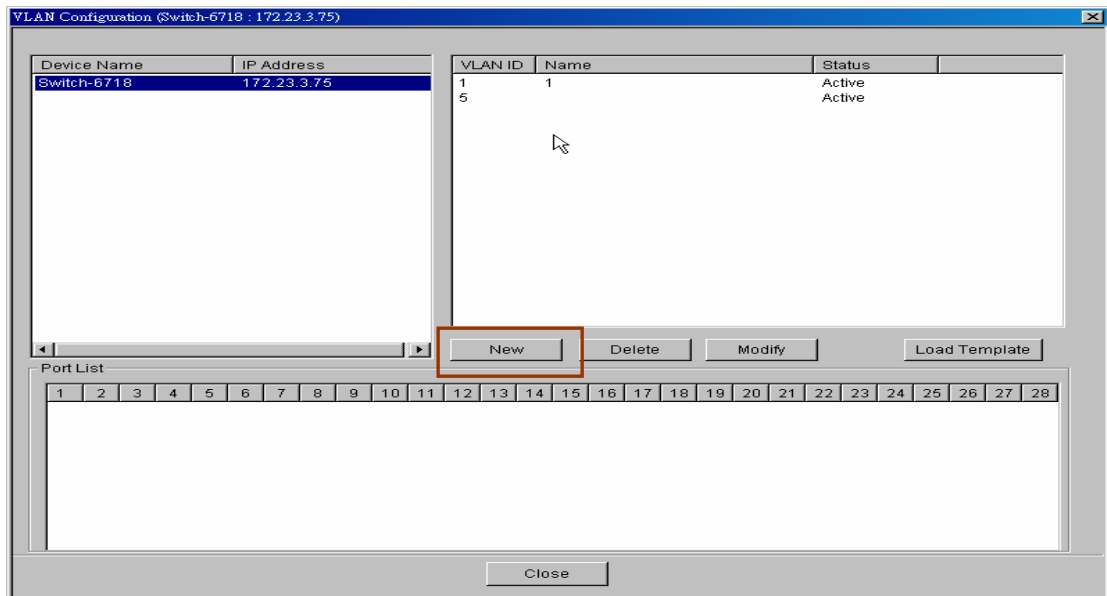

Selecting Egress ports and defines them to be tagged or untagged in Figure 17

Figure 17 Selecting the ports

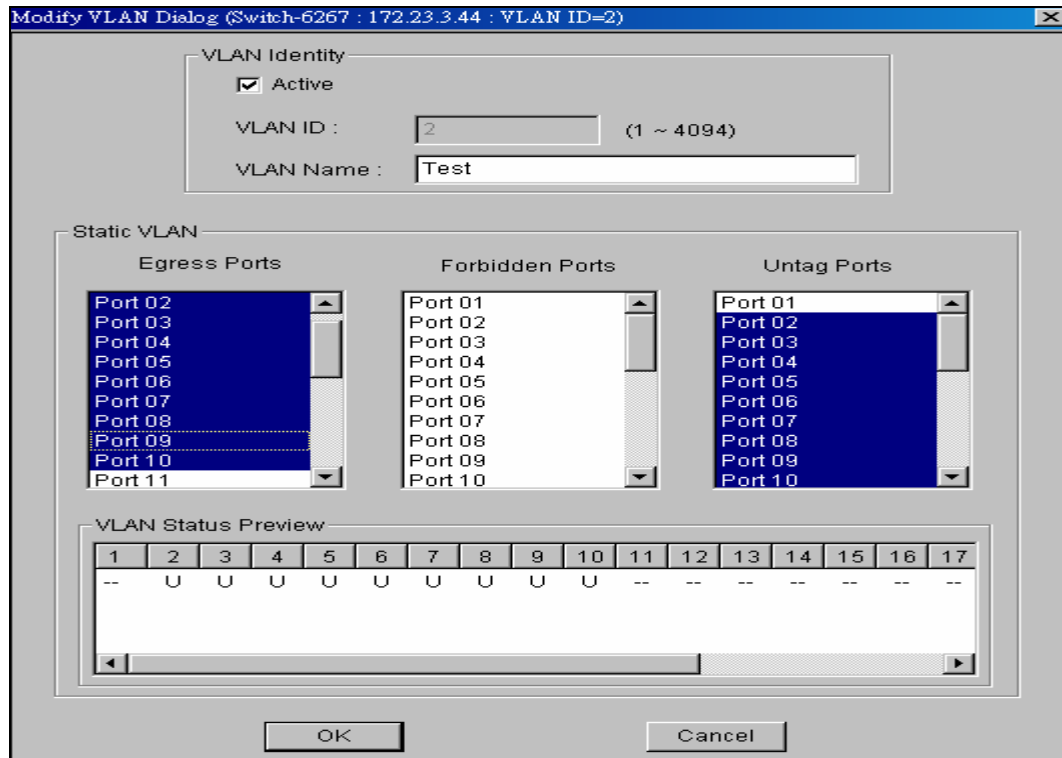

For more information, reference the user guide of NetAtlas.

Cluster Management Overview

Cluster Management allows you to manage up to 24 switches through a single IP to manage up to 24 switches simultaneously in the same broadcast domain and the same VLAN group ID. The cluster manager which can manage other switches is called the master device. The other terminology we use for cluster management is “istacking”.

- **How Cluster Management works**

Step 1:

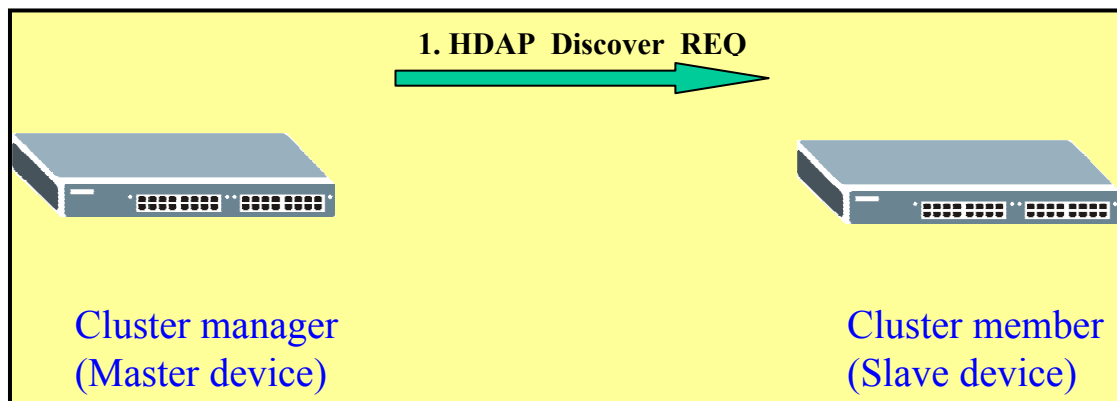

To discover the clustering members, the clustering Manager broadcasts a HDAP (Host Discovery and Address assignment Protocol) Discover request.

Step 2:

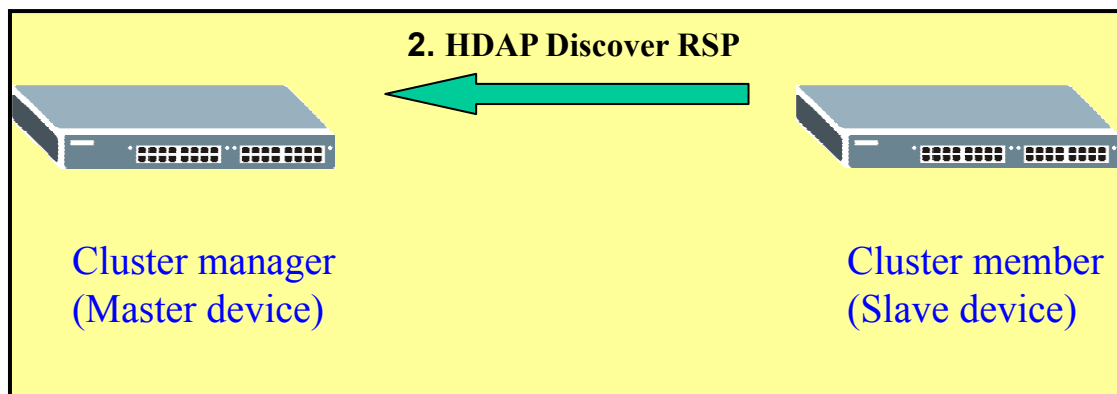

A clustering member listens on UDP port 263. When a clustering member receives a request with the matching signature, it answers with a HDAP Discover Response. In the response, the clustering member provides identity information about itself.

Step 3:

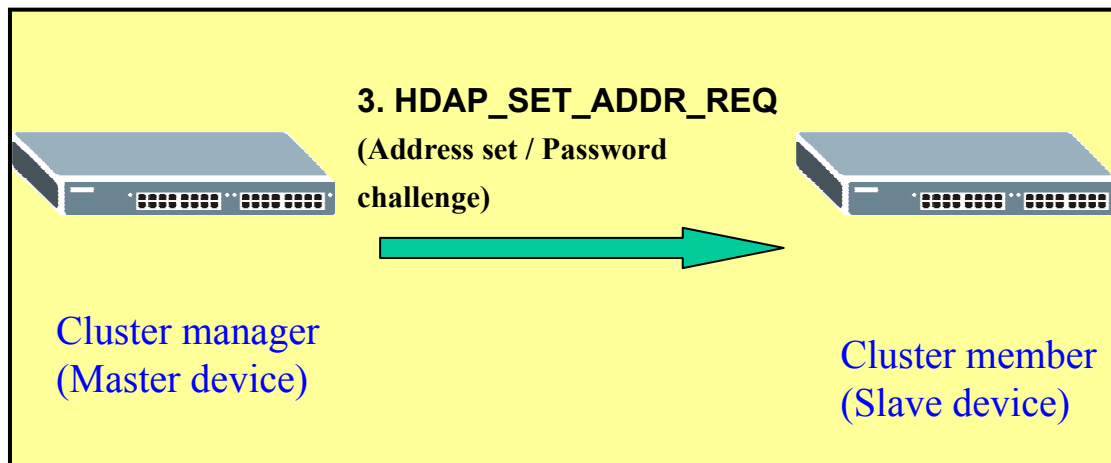

HDAP_SET_ADDR_REQ (Master device) packet request is used for a clustering manager to assign an IP address and subnet mask to a clustering member.

Step 4:

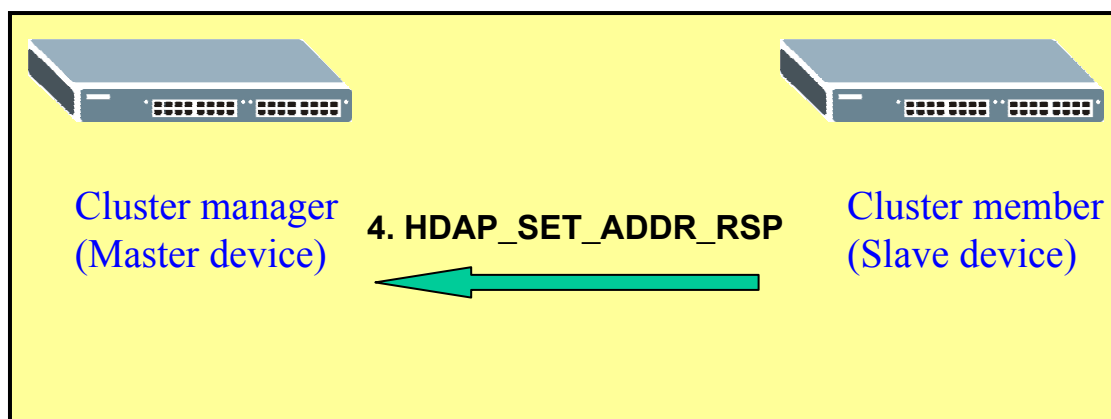

HDPA_SET_ADDR_RSP (Slave device) packet response is for a clustering member to acknowledge a "Set Address" request. The hardware address uniquely identifies the sender of this response.

After the processes are done, the cluster master will be able to manage the

slave switch.

- **How to set up Cluster Management in switch**

Step 1:

Clustering Management Configuration [Status](#)

Clustering Manager:

Active

Name

VID

Clustering Candidate:

List

Password

Index	HwAddr	Name	Model	Remove
-------	--------	------	-------	--------

Go to menu: "Management" → "Cluster Management" → "Clustering Management Configuration"

In "Clustering Management Configuration" pages, check the "Active" check box to enable Cluster Manager.

In the middle of this page, there is a table shows all the clustering candidates which can be selected and added as the clustering members.

Step 2:

Active	<input checked="" type="checkbox"/>
Name	Master
VID	1

Clustering Candidate:

List	00:a0:c5:3c:4e:43/ES-3024/ES-3024 00:a0:c5:ab:03:08/ES-4024/ES-4024
------	--

Password	****
----------	------

Select a device in the Clustering Candidate table and enter the password which is the admin password for the candidate device to add the clustering member.

Step 3:

Clustering Management Status Configuration	
Status	Manager
Manager	00:a0:c5:ab:03:03

The Number Of Member = 2

Index	HwAddr	Name	Model	Status
1	00:a0:c5:3c:4e:43	ES-3024	ES-3024	Online
2	00:a0:c5:ab:03:08	ES-4024	ES-4024	Online

Click on the index number to manage the selected clustering member.

Step 4:

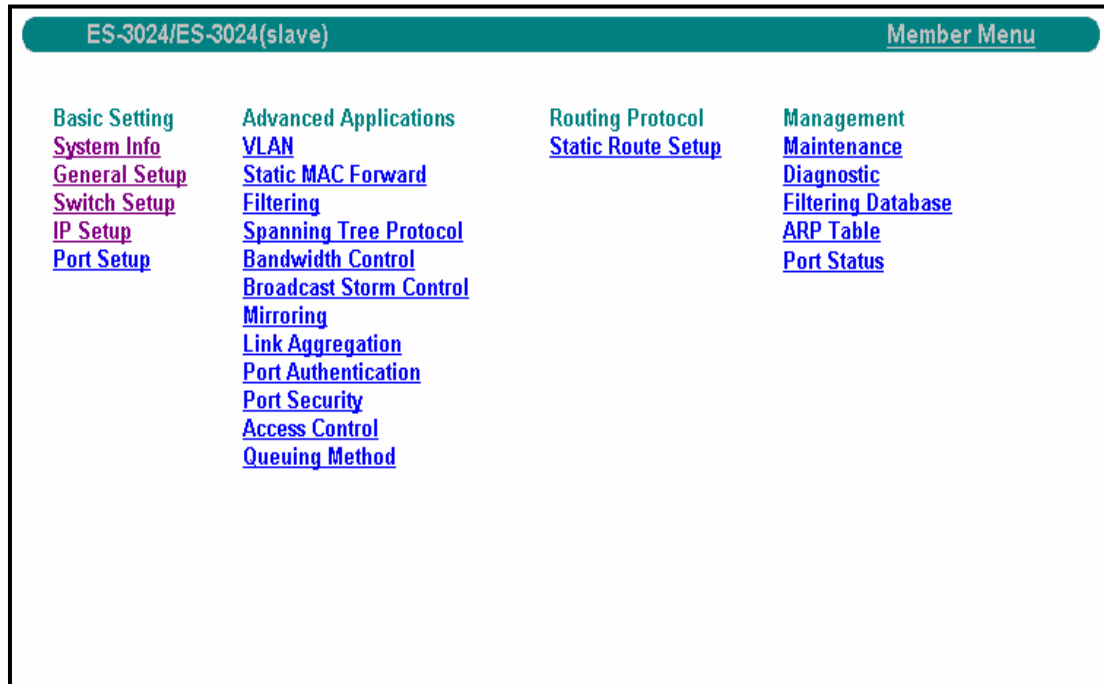

In “**Member Menu**” pages, you can change any setting of the clustering member, except **Cluster Management, Firmware Upgrade and Restore Configuration**.

Step 5:

Clustering Management Status [Configuration](#)

Status	Manager
Manager	00:a0:c5:ab:03:03

The Number Of Member = 2

Index	HwAddr	Name	Model	Status
1	00:a0:c5:3c:4e:43	ES-3024(slave)	ES-3024	Offline
2	00:a0:c5:ab:03:08	ES-4024	ES-4024	Online

Enter “Management”->”Cluster Management”->”Clustering Management Status:” In “Clustering Management Status” pages, you can check the status for each member.

Step 6:

Clustering Candidate:

List

Password

Index	HwAddr	Name	Model	Remove
1	00:a0:c5:3c:4e:43	ES-3024(slave)	ES-3024	<input type="checkbox"/>
2	00:a0:c5:ab:03:08	ES-4024	ES-4024	<input checked="" type="checkbox"/>

Enter “Management”->”Cluster Management”->”Clustering Management Configuration:” In “Clustering Management Configuration” pages , by

checking the remove checkbox and then, click on the **Remove** button to remove a cluster member.

Overview of RMON

Remote Monitoring (RMON) is a standard monitoring specification that enables various network monitors and console systems to exchange network-monitoring data. RMON provides network administrators with more freedom in selecting network-monitoring probes and consoles with features that meet their particular networking needs.

RMON was originally developed to address the problem of managing LAN segments and remote sites from a central location. The RMON specification, which is an extension of the SNMP MIB, is a standard monitoring specification. Within an RMON network monitoring data is defined by a set of statistics and functions and exchanged between various different monitors and console systems. Resultant data is used to monitor network utilization for network planning and performance-tuning, as well as assisting in network fault diagnosis.

RMON solutions are comprised of two components: a probe (or an agent or a monitor), and a client, usually a management station. Agents store network information within their RMON MIB and are normally found as embedded software on network hardware such as routers and switches although they can be a program running on a PC. Agents can only see the traffic that flows through them so they must be placed on each LAN segment or WAN link that is to be monitored. Clients, or management stations, communicate with the RMON agent or probe, using SNMP to obtain and correlate RMON data.

Now, there are a number of variations to the RMON MIB. For example, the Token Ring RMON MIB provides objects specific to managing Token Ring networks. The SMON MIB extends RMON by providing RMON analysis for switched networks.

RMON Groups

RMON delivers information in nine RMON groups of monitoring elements, each providing specific sets of data to meet common network-monitoring

requirements. Each group is optional so that vendors do not need to support all the groups within the Management Information Base (MIB). Some RMON groups require support of other RMON groups to function properly. Table 1 summarizes the nine monitoring groups specified in the RFC 1757 Ethernet RMON MIB.

Table 1: RMON Monitoring Groups

RMON 1 MIB Group	Function	Elements
Statistics	Contains statistics measured by the probe for each monitored interface on this device.	Packets dropped, packets sent, bytes sent (octets), broadcast packets, multicast packets, CRC errors, runts, giants, fragments, jabbers, collisions, and counters for packets ranging from 64 to 128, 128 to 256, 256 to 512, 512 to 1024, and 1024 to 1518 bytes.
History	Records periodic statistical samples from a network and stores for retrieval.	Sample period, number of samples, items sampled.
Alarm	Periodically takes statistical samples and compares them with set thresholds for events generation.	Includes the alarm table and requires the implementation of the event group. Alarm type, interval, starting threshold, stop threshold.
Host	Contains statistics associated with each host discovered on the network.	Host address, packets, and bytes received and transmitted, as well as broadcast, multicast, and error packets.
HostTopN	Prepares tables that describe the top hosts.	Statistics, host(s), sample start and stop periods, rate base, duration.

Matrix	Stores and retrieves statistics for conversations between sets of two addresses.	Source and destination address pairs and packets, bytes, and errors for each pair.
Filters	Enables packets to be matched by a filter equation for capturing or events.	Bit-filter type (mask or not mask), filter expression (bit level), conditional expression (and, or not) to other filters.
Packet Capture	Enables packets to be captured after they flow through a channel.	Size of buffer for captured packets, full status (alarm), number of captured packets.
Events	Controls the generation and notification of events from this device.	Event type, description, last time event sent

Groups of RMON MIB

The objects are arranged into the following groups:

Statistics

(iso(1).org(3).dod(6).internet(1).mgmt(2).mib-2(1).rmon(16).statistics(1))

History	(1.3.6.1.2.1.16.2)
Alarm	(1.3.6.1.2.1.16.3)
Hosts	(1.3.6.1.2.1.16.4)
hostTopN	(1.3.6.1.2.1.16.5)
Matrix	(1.3.6.1.2.1.16.6)
Filter	(1.3.6.1.2.1.16.7)
Capture	(1.3.6.1.2.1.16.8)

Event (1.3.6.1.2.1.16.9)

All groups in this MIB are optional. (MIB-II is **mandatory**)

Scenario (GS-3012 Series supports RMON 1.2.3.9)

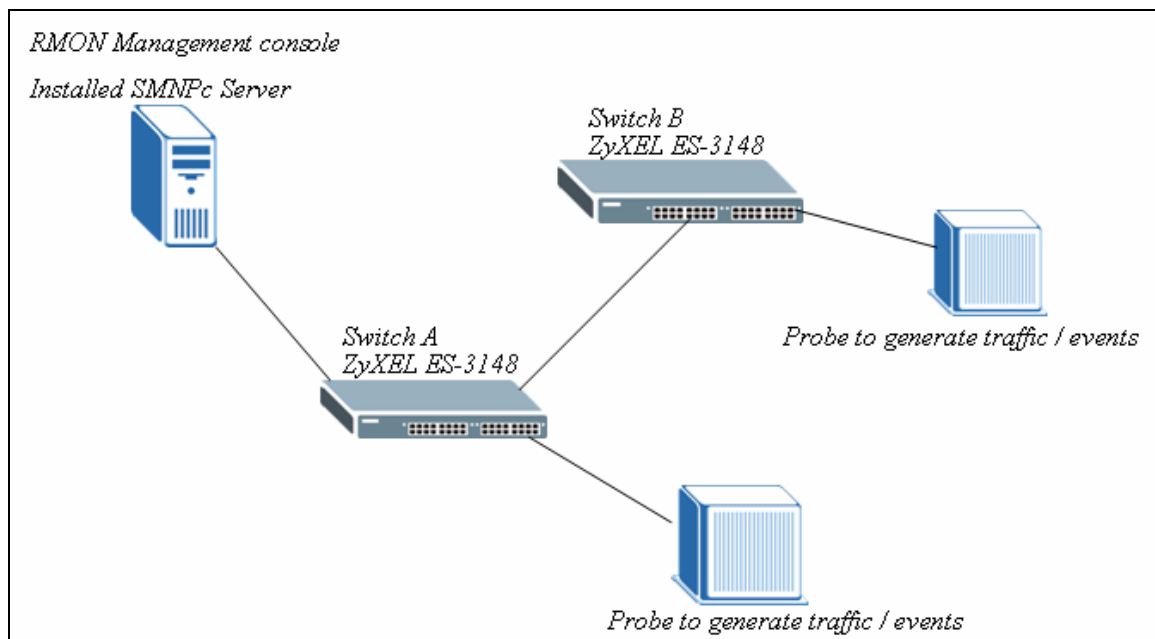

In this illustration, SNMPc Enterprise Edition Version 5.1.6c is installed on the PC. And this PC is defined as “RMON management console”. This PC can ping both ZyXEL ES-3148 (both Switch A & Switch B). And there are some probes / networking devices to generate the traffic to the ZyXEL Switches in order to verify the RMON result. Since the work flow and the technology of RMON on the two switches are the same, only one of the ZyXEL ES-3148 Switch will be demonstrated at this time.

Since RMON is an extension of the SNMP, SNMP must be enabled first in the ZyXEL ES-3148. By default SNMP is enabled and it has set Community (Get,Set,Trap) to “public”. And Trap Destination to 0.0.0.0; It is not mandatory to change the default value in order for SNMP & RMON to work. Therefore, modification is not necessary in this case.

In this scenario, we are going to monitor the Broadcast Packets by using the RMON MIB. The following will demonstrate the steps to monitor the Broadcast Packets by using SNMPc Enterprise Edition Version 5.1.6c.

1. Methodology of Scenario Verification

1. Open your SNMPc program first, then pick the ZyXEL-3148 Switch (it is first named as device “root”) and give it the correct IP information to get the SNMP information. Also, you can rename it to whatever you want.

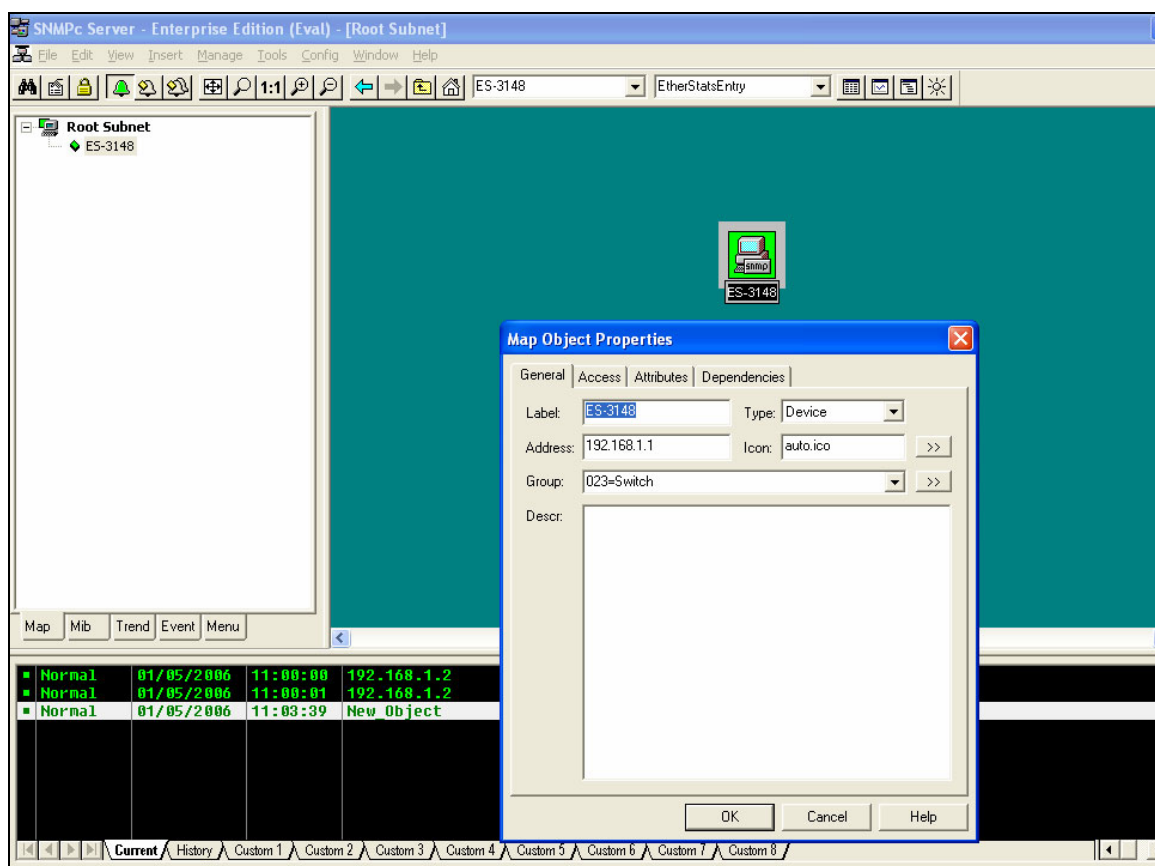

You can verify if your configuration is correct by using the “Poll Object” option. Just right click our mouse on the ES-3148 icon and it is located inside the “Tools”.

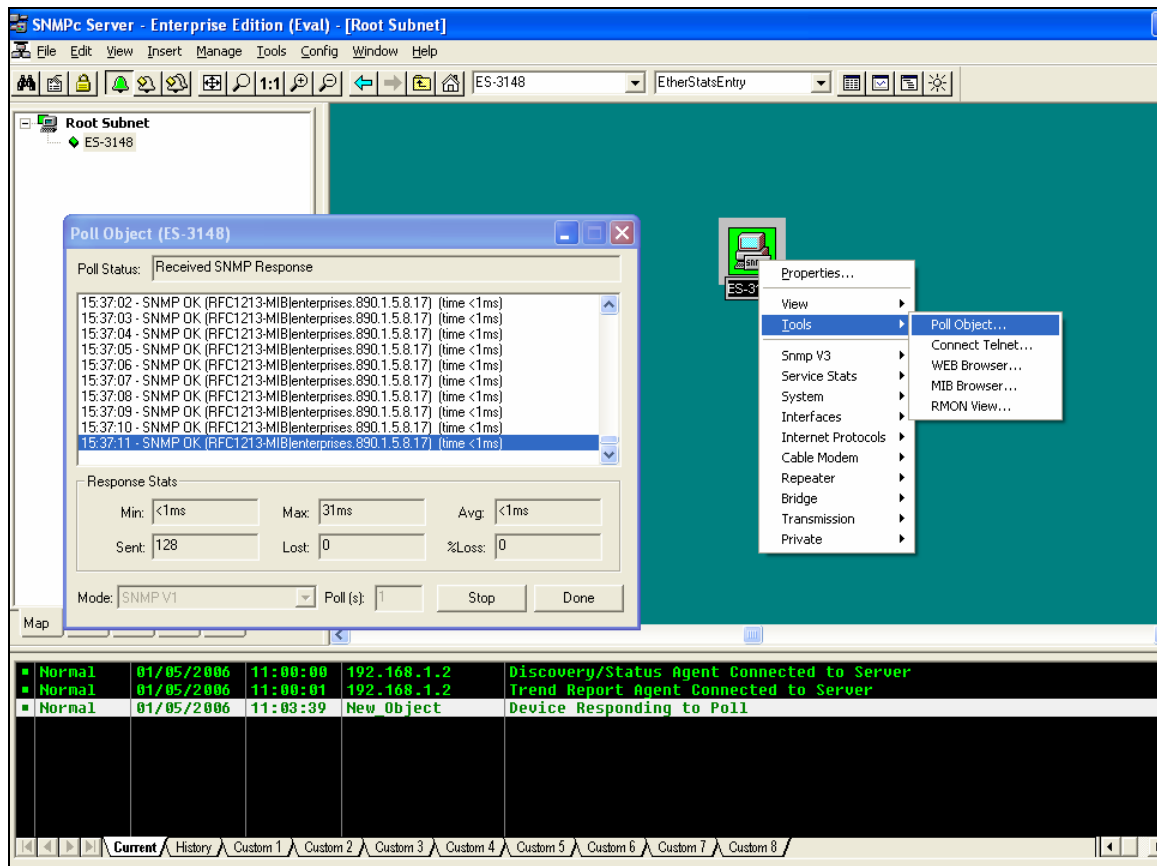

- Secondly, click on the “Mib” tab and expand the SNMP Mibs’ tree. You will find that there is an “rmon” group over there and again you can expand its sub-tree.

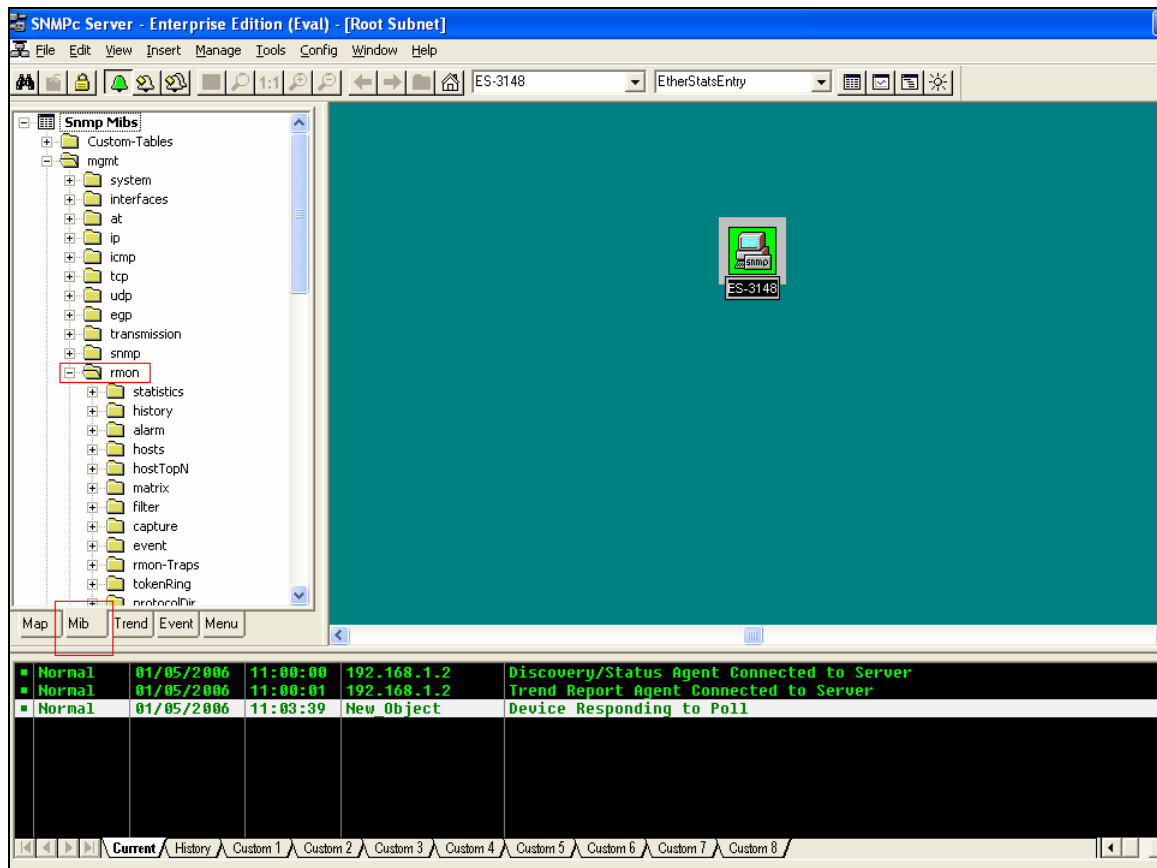

3. Right click the “etherStatsTable” and choose “View Table”

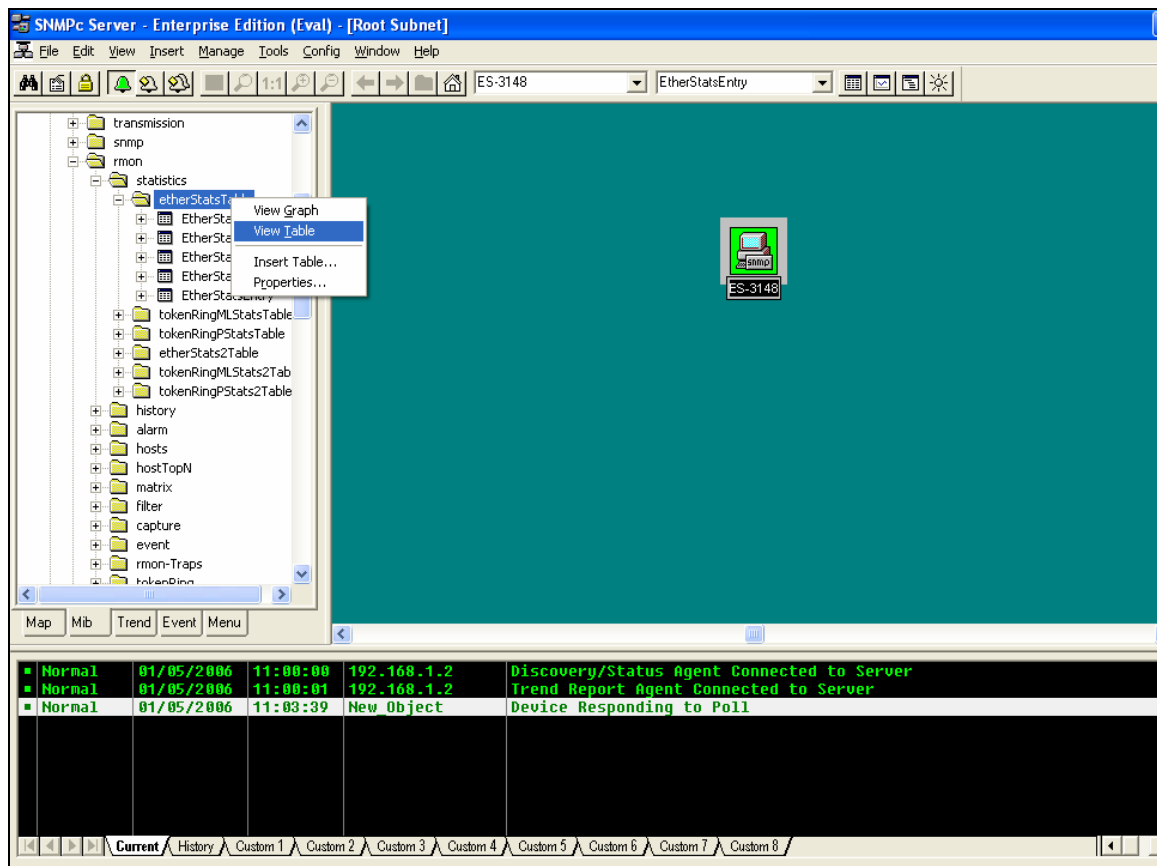

- Find the interface or port that you are looking for. And you can look at the corresponding field and therefore find the value that you want to monitor. In this case, we are looking for the Broadcast Packets.

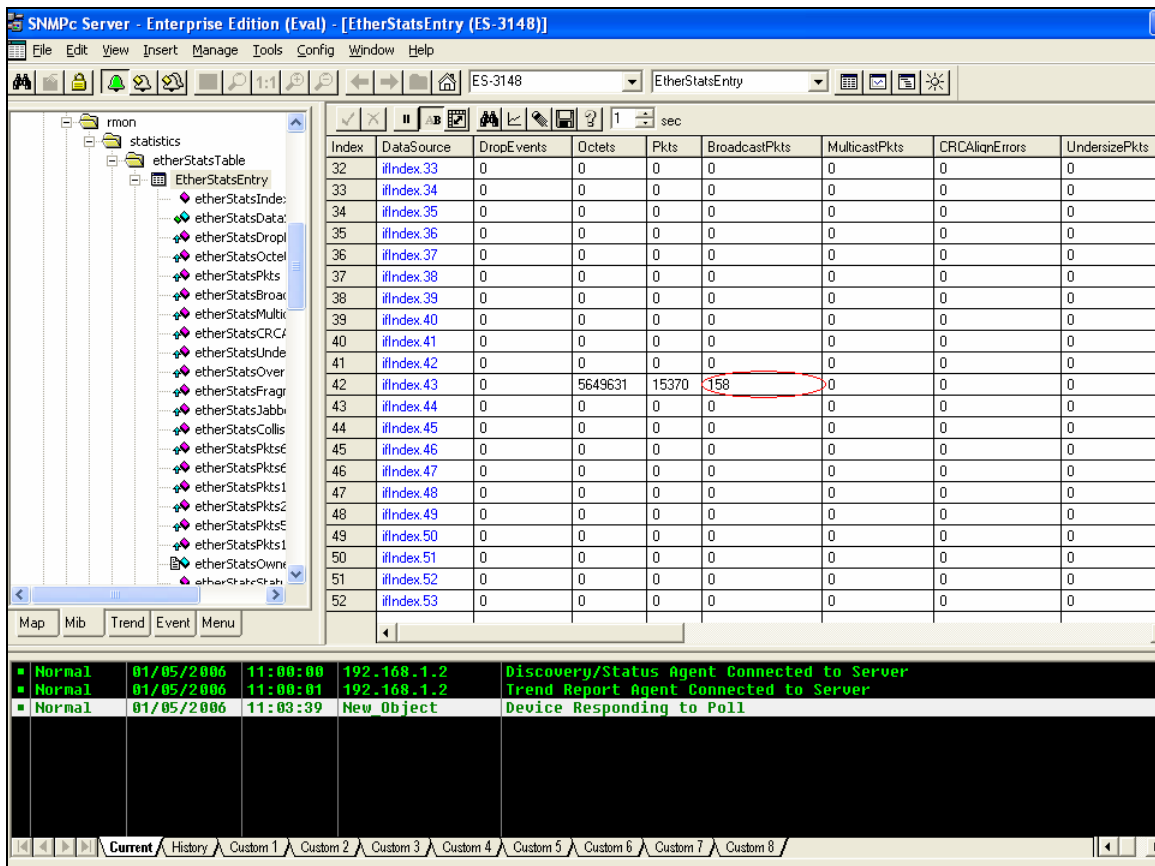

Try to generate some broadcast traffic from the probe or your network device, then you should see the BroadcastPkts increasing.

- In conclusion, if the Switch supports RMON, then you can get the values from the Switch in the RMON Group(s), otherwise, it will return 0 and always stays 0. Without the supporting of RMON, then it is impossible to monitor those elements in the RMON MIB Group

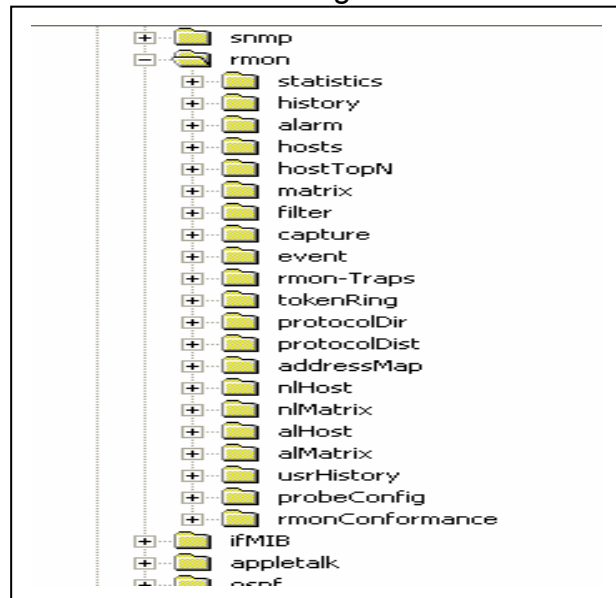

FAQ

What is the default setting of the IP parameters?

IP address: 192.168.1.1

Subnet: 255.255.255.0

What is the default login Name and Password of the Web Configurator?

ID: admin

Password: 1234

How to access my SWITCH through the console port?

Connect the male 9-pin end of the console cable to the console port of the Switch. Connect the female end to a serial port (COM1, COM2 or other COM port) of your computer, which has terminal emulation software configured to the follow parameters:

Terminal emulation: VT100

Baud rate: 9600 bps

Data bits: 8

Parity: none

Stop bit: 1

Flow control: none

What is default login password of the console, telnet, and FTP?

Password: 1234

How to change the password?

Web Configurator is the only place you can change the password. After you log in for the first time, it is recommended you change the default administrator password.

From Web Configurator: Click Advanced Application, Access Control, and then Logins to display the next screen.

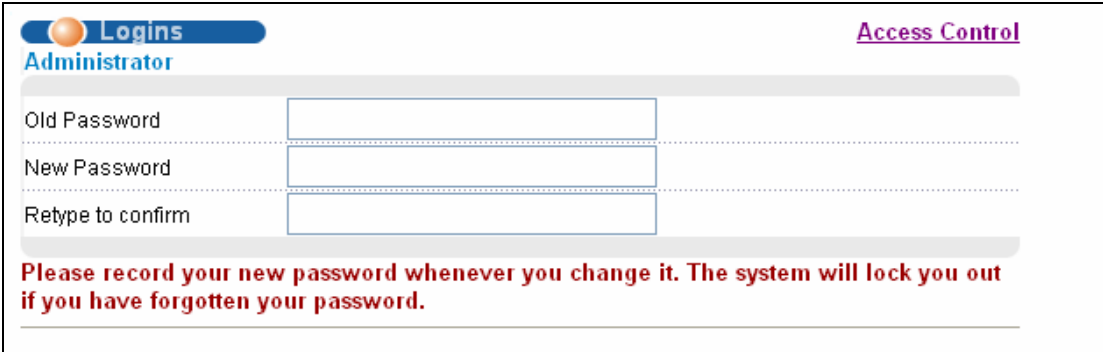

Logins [Access Control](#)
Administrator

Old Password

New Password

Retype to confirm

Please record your new password whenever you change it. The system will lock you out if you have forgotten your password.

From there you can change a new password.

How to access the Command Line Interface?

There are two ways to access the Command Line Interface. One is “Telnet to the switch” and another is “Connect a computer to the console port and use the terminal emulation software.” Please check “How to access the Switch through the console port?” to set up the parameters.

If you forget the password, how to reset the password to default?

If you forget the password, you will need to reload the factory default configuration. Please be aware that you will lose all previous configurations.

1. Connect the console cable to your computer and open the terminal emulation software.

2. Power off and then power on the Switch, and press any key to enter the debug mode when the screen shows “Press any key to enter Debug Mode within 3 seconds.”
3. Type “atlc” and press the enter key
4. When the message “starting XMODEM upload” appears, do XMODEM upload of the default rom file to the Switch
5. After it is done uploading the rom file successfully, type “atgo” to leave the debug mode.
6. The system will be restarted automatically. After the system is up, you should be able to log in with the default password “1234” and the IP address is now 192.168.1.1.

How do I configure an IP address?

From Web Configurator:

Click Basic Setting and then IP Setup to display the next screen.

<input type="radio"/> DHCP Client	
<input checked="" type="radio"/> Static IP Address	
IP Address	192.168.1.1
IP Subnet Mask	255.255.255.0
Default Gateway	0.0.0.0
Management VID	1
IP Address	192.168.0.1
IP Subnet Mask	255.255.255.0
Default Gateway	0.0.0.0

Is Online Help available on the Web Configurator?

Yes, the Web Configurator's Online Help is available. Clicking on the Help link will bring up a description of the online help of that screen.

How to restart device from Web?

1. Click Management and then Maintenance in the navigation panel to display the following screen.

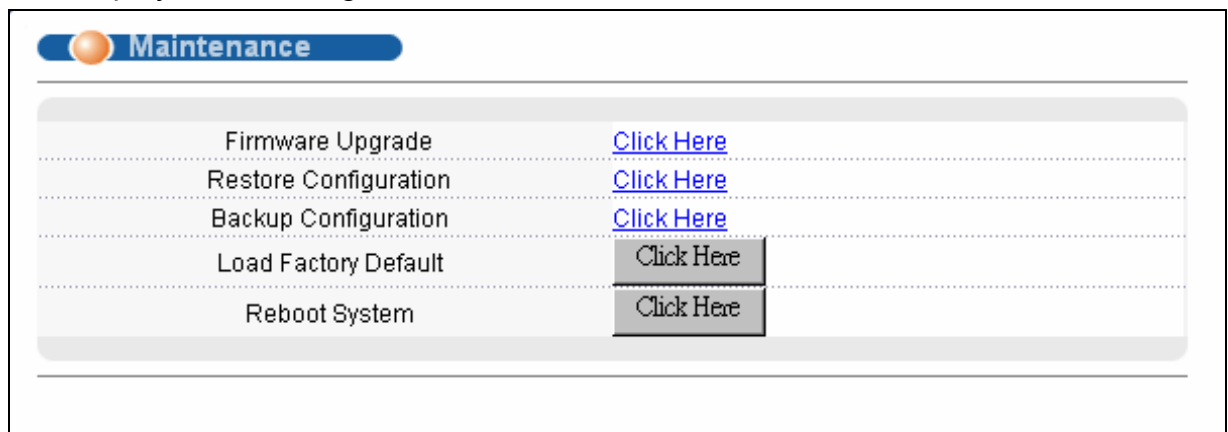

2. Click on the "Click Here" button next to the Reboot System will restart the Switch.

How to check the current running firmware version?

From console, issuing a command, "show system-information" will return the information of the firmware version installed on the switch.

Is the mini GBIC transceiver hot-swappable?

Yes, it is hot-swappable. You can change transceivers while the switch is

operating.

What is so called "Dual-Personality interface" in Ethernet Switching?

Dual-Personality GbE interface means that one 1000Base-T Copper port and one SFP port share the same physical interface. Only one of them can be used at one of a time. Dual-Personality interface is also called "Combo Port" in some cases.